

STEALTH

STL110 Installation Manual



STL110



STL110H



STL110HB



STL110R

Specifications:

Switching Capacity:	8 amps
Voltage:	120 volts 1000 watts Incandescent 500 watts Fluorescent
Detection Pattern:	50' x 110°
Time Adjustment:	5 seconds to 12 minutes
Power Consumption:	1 watt
Surge protection:	I.E.C. specs
UL Listing:	Raintight Photoelectric Switch



RAB

Cautions:

TURN OFF ALL POWER AT
CIRCUIT BREAKER/FUSE PANEL.

- Read entire Installation Manual before proceeding.
- All wiring should comply with local electrical codes and requires a qualified electrician.
- The total lighting load connected to Stealth must not exceed 8 amps (1000 watts incandescent or quartz, 500 watts fluorescent). To switch more wattage an electrician can install a relay.
- Line Carrier Remote Control Systems such as X-10, Leviton or Radio Shack are incompatible with sensors and cause false activations.
- Do not install sensors on a circuit that feeds motor loads like kitchen appliances, HVAC equipment, washer/dryer, or garage door openers.
- Sensor must be below and as far as possible away from lights.
- Sensor functions best when the direction of expected movement is across its detection pattern, not towards the sensor.
- Mount 6–12 feet high for optimum range and detection.

Mounting Plate:

STL110 floodlight kits come pre-wired and assembled on the RAB CU4 EZ plate, allowing for mounting on round, rectangular or octagonal surface or recessed boxes.

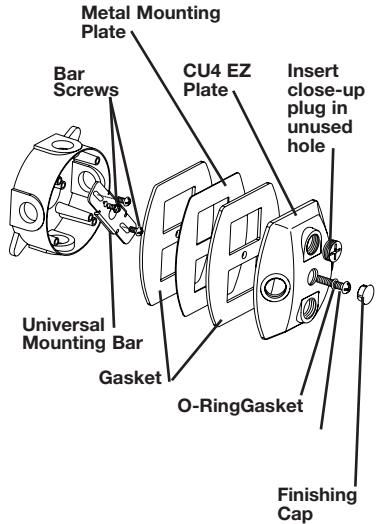

How Does the STEALTH Work?

Stealth's infrared sensor "sees" small temperature changes caused by the motion of people or cars within its protection zone and turns on lights automatically. It welcomes visitors and may deter intruders.

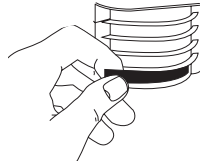

How long do the lights stay on?

Lights remain on as long as there is movement within the protection zone. Once the zone is vacated lights can be adjusted to remain on approximately 5 seconds up to 12 minutes. Since the lights are on only when needed, and the sensor uses only one watt the Stealth is extremely energy efficient.

Can outdoor lights still be turned on with the light switch?

Yes. Stealth can be controlled by a conventional indoor switch or circuit breaker. Lights can be turned on or off manually at night only.

- **Manual Override Mode:** (to keep lights on) Flip the switch twice slowly (off-on-off-on) within 2-3 seconds.
- **To Resume Automatic Mode:** Flip the switch once (off-on) within 2 seconds. Sensor will reset to Automatic Mode.

Will Stealth detect animals?

Stealth may detect large animals. Having animals trigger the sensor can give property a "lived-in" look. However, you can limit animal detection by turning down the sensitivity knob and/or by placing opaque weatherproof tape on the lower part of the lens.

How are the Time, Sensitivity and Photocell adjusted?

- **Time:** Sets the time that lights will remain on after the detection zone is vacated from approximately 5 seconds to 12 minutes. Factory Setting: 5-8 minutes
- **Sensitivity:** Increases or decreases the responsiveness and range of the sensor (Adjusts from 30% to 100%) Factory Setting: 100%
- **Photocell:** Located behind the lens. For night only operation, turn the knob all the way clockwise to (to the moon symbol). For 24 hour operation turn the knob all the way counterclockwise (sun & moon). Adjust clockwise to have the sensor come on later at dusk, counterclockwise to have it come on earlier. Factory Setting: Night Only

Control Panel:

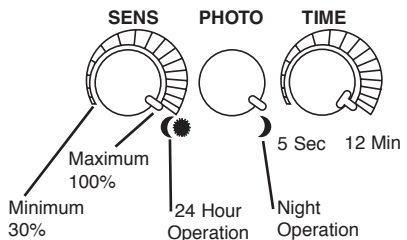

Picking a Location

- Choose a location from which the sensor can “see” all the paths of movement.
- The sensor may be wall or ceiling mounted.
- As distance from the sensor increases, it will take more movement to be detected. For instance, at 10 feet, a half step will be enough, while at 40 feet several steps will be necessary.

How large an area does Stealth detect?

The standard lens detection pattern extends out 50 feet and is 110° wide. The sensor may be swiveled in any direction to cover the area desired. Always keep the sensor level to insure full coverage. To reduce coverage tilt the sensor down.

Stealth STL110 comes with a standard “Double Look Down” Lens. This lens has one “Look Out” zone and two “Look Down” zones, for excellent detection both at long and close range.

The Long Range model STL110LRL provides a long, narrow protection zone for alleys and along buildings.

How does the LED Detection Indicator work?

The red LED above the lens shows the logic state of the sensor. If the sensor is set for night only operation, the LED will go on for daytime detections without turning on the lights. At night, the LED will be on all the time, except during detections (at which time the controlled lights will go on). At night, the LED serves as a deterrent indicating a security device in operation.

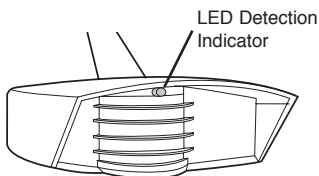

Detection Pattern

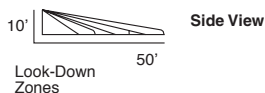
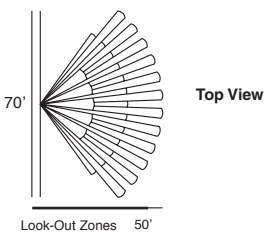

Long Range Model

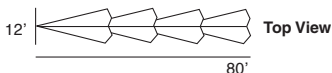

Kit Wiring



Red pigtail is only used to switch remote or additional fixtures.

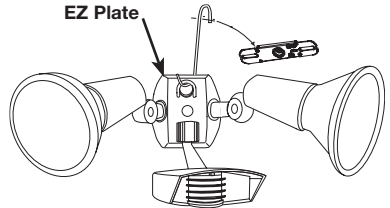

1. Attach the Universal Mounting bar with the bar screws (provided) to the junction box. If you are attaching your STL110 kit to a surface mount weatherproof box, you must use both gaskets, with the metal mounting plate

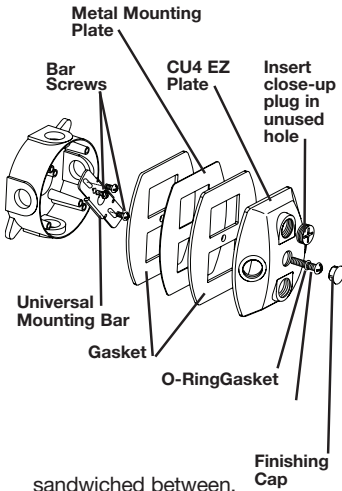

sandwiched between.

3. Bring power leads and sensor kit leads through holes in all gaskets into junction box.

4. Strip $\frac{1}{2}$ " of insulation from all leads.

5. Attach ground wire(s) to junction box grounding screw. Connect as shown in wiring diagram.

6. Twist on wire nuts. Secure with electrical tape.

7. Align gaskets, EZ Plate and metal mounting plate to insure proper seal. Tighten EZ Plate center screw (make sure O-Ring gasket is on the screw) to attach EZ Plate to the box.

8. Insert plastic Finishing Cap in the center of the EZ Plate for a weatherproof seal.

9. Use silicone sealant around all openings to insure a weatherproof seal.

10. Screw in light bulbs. Turn on power. Conduct walk test to adjust sensor response. See page #6.

2. Easy Wiring Tip:
Use the "S" shaped Hands Free Hanging Hook to hold the EZ Plate during wiring.

Wiring Diagrams

Basic Wiring Diagram

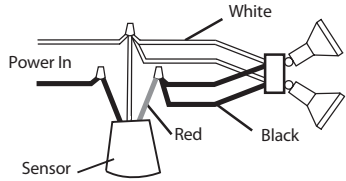

Basic Kit Wiring

Note: Pigtail is only used to switch remote or additional light fixtures

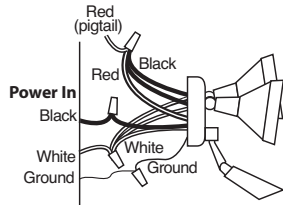

Multiple Fixtures

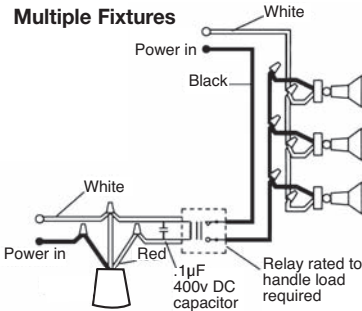

Multiple fixtures may be wired to a single sensor.

To handle loads greater than 1,000 watts, a qualified electrician should install a relay.

Switchplate Label

RAB STEALTH110
To Keep Lights On:
 Switch off-on-off-on within 2 seconds. Resets to Auto Mode at dawn.
To Set Evening Timer:
 To keep lights on for 1-8 hours after dusk, set the Evening Timer knob on the sensor, then flip this switch off-on-off-on within 3 seconds.
To Resume Auto Mode:
 Switch off for 10 seconds, then back on.

Switchplate label with self-adhesive backing.

Attach Stealth operating instruction label to switchplate for quick and easy reference.

Power Quality

It is not recommended to install sensors on a circuit that also feeds motor loads such as HVAC equipment, kitchen appliances, or garage door openers. The Stealth circuit is surge and transient protected to IEC specifications. However, if voltage varies significantly from 120 volts, sensor may malfunction.

Aiming And Walk Testing

Walk Test

The purpose of the Walk Test is to check and adjust the coverage pattern. Stealth has a 5 minute Test Period which allows the sensor to be aimed and walk tested day or night. If you require 5 more minutes of Test Time, turn the power off for at least 10 seconds and back on again. During the Test Period, the sensor will keep lights on for 5 seconds each time it detects movement in its Detection Zone. The sensor will change to Automatic Mode after 5 minutes of testing.

• To enter Test Mode:

Turn power off for at least 10 seconds and back on.

1. Aim the sensor across the traffic pattern you want to detect. Start by aiming the sensor downward and then raise it slowly until the desired range is obtained.
2. Start outside the pattern and walk across the pattern until the lights go on. As distance from the sensor increases, it will take more movement to be detected.
3. Adjust the sensor aiming as necessary to improve coverage.
4. To adjust the sensitivity turn knob gently. Less sensitivity (counterclockwise) may be desired if you wish to detect a limited area or if the sensor is being activated by wind, foliage or animals. More sensitivity (clockwise) will help cover a larger area.

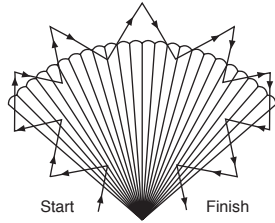

5. Repeat steps #2 thru #4 until you are satisfied with the coverage.

6. The "Time" control is factory set at approximately 5-8 minutes. This period starts after the movement in the detection pattern ceases. If less time is desired, turn the time control counterclockwise. For more time, turn the knob clockwise.

7. Stealth is factory set for night only operation. To obtain 24 hour operation, turn the photocell control full counterclockwise. Intermediate settings will adjust operation during dusk and dawn.

8. Your sensor is ready for operation. See the Technical Tips pages 7-11 if additional help is needed.

Control Panel:

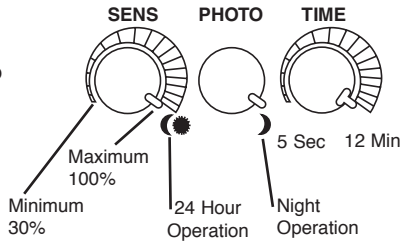

Technical Tips: Lights Do Not Turn Off

1. Make sure that the sensor is not in Manual Override Mode. Turn power OFF for 10 seconds, then ON Sensor will be in Test Mode for approximately 5 minutes, then it will switch to Auto Mode with lights off and ready to detect movement.

2. Make sure sensor is not aimed at or mounted over something that would move or change temperature such as waving branches, water, air conditioners, windows or heating vents—even on neighboring property. You can test for infrared sources in the area by placing a box or bag over the sensor. Put sensor into test mode. Lights should stay off. Wave your hand inside bag in front of sensor. Lights should go on and then time out. If sensor operates properly when covered, check items #4–7.

Problem: Sensor is triggered by unwanted movement or heat source.

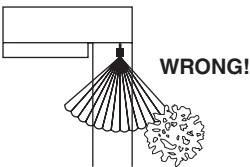

Solution: (1) Aim sensor away from movement or (2) mask lens as in the direction of the source and/or (3) lower sensitivity control setting.

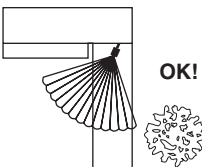

3. Make sure sensor and lights are mounted firmly and do not move even slightly when touched. If they move, tighten all screws.

4. Make sure sensor is not mounted on an unstable object such as a tree or pole that will move in the wind.

Problem:

Movement of tree triggers sensor.

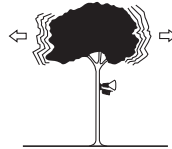

Solution: Mount on stable surface.

5. Was sensor wired hot? If so, circuitry may have been damaged.

6. Make sure sensor is not aimed within 20 feet of a road.

Problem:

Passing cars activate sensor.

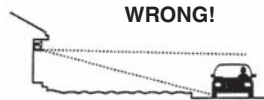

Solution: A 20 foot safety zone and lower sensitivity are recommended to avoid activation from passing cars.

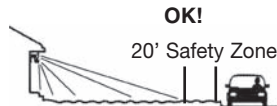

7. Make sure heat from lights is not triggering sensor. Make sure the sensor is below and as far as possible away from lights.

Technical Tips: Lights Turn On and Off Inappropriately

1. Make sure the sensor is installed on its own dedicated circuit, free of motor loads such as HVAC equipment, kitchen appliances or garage door openers.

2. It is not recommended to wire sensors in parallel. More than one sensor wired together makes them difficult to troubleshoot. Disconnect multiple sensors and test separately.

3. Keep all people completely out of the detection pattern to make sure the sensor is not detecting them.

4. Make sure sensor is located below and as far as possible from its lights. Heat from the lights may trigger the sensor.



WRONG!

Solution: Move sensor below and away from the lights.

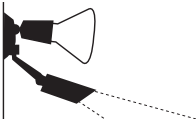

OK!

Moths can be attracted to the lights and fly close to the sensor causing triggering. Reducing the sensitivity may help.

6. Make sure sensor is not aimed

within 20 feet of a road or sidewalk. Passing cars will activate sensor. Solution:

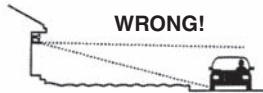

WRONG!

A 20 foot safety zone and reduced sensitivity are recommended to avoid activation from passing cars.

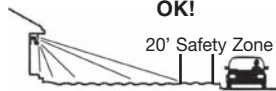

OK!

20' Safety Zone

7. Heavy rain, snow or high winds may activate the sensor occasionally. Reduce sensitivity control slightly until problem stops.

8. Make sure lights are not reflecting back into sensor. Check for white or reflective surfaces close to the sensor.

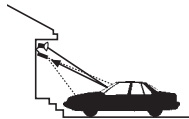

5.

Solution: Aim sensor away from reflective objects, or move the objects and lower sensitivity.

9. Self ballasted PL lamps may cause cycling (on-off).

10. Check Solutions #2, 4, 5, 6, and 7 under "If Lights Do Not Turn Off".

Technical Tips: Lights Do Not Turn On

1. Check that lamps and fixtures work. Compare wiring to the wiring diagram in this manual. Check that the power is on.
2. If installing during daylight, remember that the sensor will provide 5 minutes of Test Time after power is turned on. After 5 minutes, the sensor will switch to Automatic Mode and will not work during daylight if the photocell control is turned to the night only position (moon symbol).

If you require 5 more minutes of Test Time, turn the power off for at least 10 seconds and back on again.

If you require the sensor to operate both day and night, turn the center control knob counterclockwise to the sun and moon symbol.

3. Check that lights from another source, such as adjacent porch lights, garden lights or street lights are not in the sensor's view. The sensor's photocell may detect the light and deactivate "daylight". If you desire the sensor to operate in higher ambient light levels, turn the photocell control (center knob) toward the sun symbol.

4. Was sensor wired hot? If so circuitry may have been damaged.

Lights Turn Off Too Quickly

1. Check if sensor is being "tricked" by reflected light. If lights controlled by the sensor shine or reflect into the photocell (located behind the lens) the unit will go on briefly, see its own light, and turn off "thinking" that it is daytime:

Problems:

Lights reflect into photocell, or
Lights shine directly into photocell



Solution:

Adjust photocell control (center knob) slightly counterclockwise, to allow operation at higher ambient light levels. Alternatively, move the lights or reflectors or mask the lens in the direction of the lights and/or reflections.

2. Check if "R" lamps, non-reflector "A" lamps or self-ballasted PL lamps are being used in a non-enclosed lampholder. If so, switch to reflector PAR floodlight lamps or Quartz floods so the sensor is not affected by stray light. If using PAR floodlights, consider using lower wattage, energy saving lamps.

Technical Tips: Range Appears Limited

1. Check that the sensor is level from side to side and pointed at the area you desire. If unit is tilted, part of the detection zone may be high in the air over people's heads.



Solution: Position sensor exactly level from side to side.



2. Check that the sensor is not mounted too high. If mounted above 20 feet, much of the usable range will be lost.

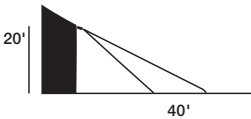

Solution: Mounting at 6 feet to 12 feet allows maximum range.



3. Check that movement is not directly towards sensor. Sensor will see movement across its pattern more quickly. To fix, move the sensor.

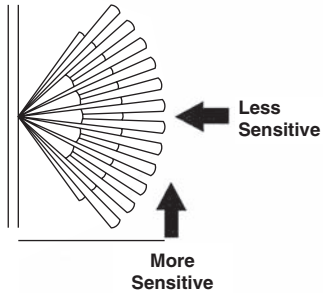

4. Check that movement far away and directly towards sensor is not entirely within one zone.

Problem:

Sensor will not detect until

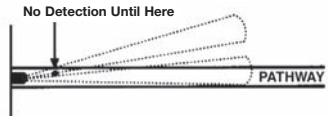

movement crosses zones

Solution:

“Micro Adjust” sensor by moving sideways 1/4". This may move the zones to

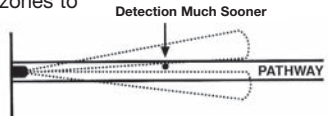

Technical Tips: Lights Turn On for Unknown Reasons

1. Lights may turn on occasionally during rain, snow and windstorms because the sensor is detection changes in temperature.

Solution:

Mount sensor in protected area.

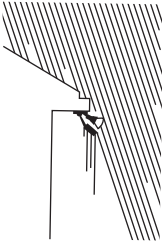

If false detections are a constant problem, reduce sensitivity (turn counterclockwise) until the problem stops.

2. Tilt the sensor lower, it may be seeing distant objects moving.

3. You may not be aware that animals have triggered the sensor. Check sensor aiming to reduce nuisance triggering or mask the lower part of the lens with opaque weatherproof tape to create an “Animal Alley”.



4. Although it is surge and transient protected, the sensor may turn on occasionally during extreme voltage surges.

5. A possible source of “mysterious” sensor activations are strong local radio signals. Check for nearby CB, Ham, VHF radio transmitters or Cellular telephones. The sensor may be activated but will not be permanently impaired by these signals.

6. Check all the Solutions mentioned under “Lights Turn On and Off”.

7. Check items #2, 4, 5, 6 and 7 under “Lights Do Not Turn Off.”

Limited Warranty

Your Stealth will be replaced or repaired, at our option, if it proves to be defective in workmanship or materials within ten years from the date of original purchase.

For repair replacement, return the product freight prepaid and insured to:

RAB Lighting
170 Ludlow Avenue
Northvale, NJ 07647

The Stealth should be packed carefully. Please include your sales receipt and a description of the problem.

If your unit is out of warranty or the damage is unrelated to the original manufacture, return your unit directly to us with a check for \$20.00 (made out to RAB Electric). We will repair or replace your unit.

Under no circumstances shall we be liable for any incidental or consequential damages arising out of or in connection with the use or performance of this product or other indirect damages with respect to loss of property or revenue or cost of installation, removal or re-installation. This warranty gives you specific legal rights and you may also have other rights which vary from state to state.

Contents of Accessory Kit

- Indoor Switchplate Label
- 3 Wire Nuts



- Crossbar with Green Ground Screw
- Hanging Hook
- 1/2" Close Up Plugs (3)
- Slotted Screws (4)
- Finishing Cap
- O-ring Gasket
- Center Mounting Screw

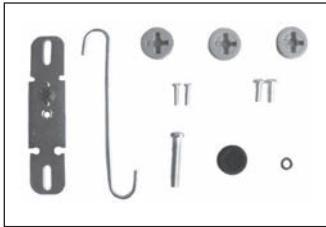

- Foam Gaskets (2)
- Metal Plate



Easy Installation & Product Help

Toll Free Phone

Call our friendly experts.
8AM - 6PM ET Mon. - Fri.
888 RAB-1000

E-mail

Questions and requests
answered promptly
tech@rabweb.com

RAB Lighting
170 Ludlow Avenue
Northvale, New Jersey 07647
U.S.A.

© RAB Lighting 2004

Toll Free Fax

Send faxes to RAB
24/7.
888 RAB-1232

www.rabweb.com

Visit our internet site
for product information

Fax on Demand

Faxed information,
24/7.
888 RAB-1236



STEALTH

STL200 Installation Manual



STL200



STL200HB



STL200H

Specifications:

Switching Capacity: 8 amps

Voltage: 120 volts

1000 watts Incandescent

500 watts Fluorescent

Detection Pattern: 50' x 200°

Time Adjustment: 5 seconds
to 12 minutes

Power Consumption: 1 watt

Surge protection: I.E.C. specs

UL Listing: Raintight
Photoelectric
Switch



RAB

Cautions:

TURN OFF ALL POWER AT
CIRCUIT BREAKER/FUSE PANEL.

- Read entire Installation Manual before proceeding.
- All wiring should comply with local electrical codes and requires a qualified electrician.
- The total lighting load connected to Stealth must not exceed 8 amps (1000 watts incandescent or quartz, 500 watts fluorescent). To switch more wattage an electrician can install a relay.
- Line Carrier Remote Control Systems such as X-10, Leviton or Radio Shack are incompatible with sensors and cause false activations.
- Do not install sensors on a circuit that feeds motor loads like kitchen appliances, HVAC equipment, washer/dryer, or garage door openers.
- Sensor must be below and as far as possible away from lights.
- Sensor functions best when the direction of expected movement is across its detection pattern, not towards the sensor.
- Mount 6–12 feet high for optimum range and detection.

Mounting Plate:

STL200 floodlight kits come pre-wired and assembled on the RAB CU4 EZ plate, allowing for mounting on round, rectangular or octagonal surface or recessed boxes.

Mounting

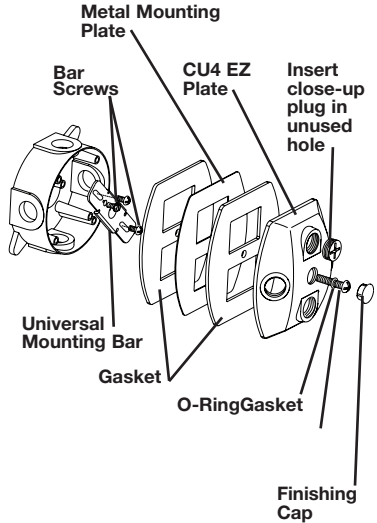

How Does the STEALTH Work?

Stealth's infrared sensor "sees" small temperature changes caused by the motion of people or cars within its protection zone and turns on lights automatically. It welcomes visitors and may deter intruders.

How long do the lights stay on?

Lights remain on as long as there is movement within the protection zone. Once the zone is vacated lights can be adjusted to remain on approximately 5 seconds up to 12 minutes. Since the lights are on only when needed, and the sensor uses only one watt the Stealth is extremely energy efficient.

Can outdoor lights still be turned on with the light switch?

Yes. Stealth can be controlled by a conventional indoor switch or circuit breaker. Lights can be turned on or off manually at night only.

- Manual Override Mode: (to keep lights on) Flip the switch twice slowly (off-on-off-on) within 2-3 seconds.
- To Resume Automatic Mode: Flip the switch once (off-on) within 2 seconds. Sensor will reset to Automatic Mode.

Will Stealth detect animals?

Stealth may detect large animals. Having animals trigger the sensor can give property a "lived-in" look. However, you can limit animal detection by turning down the sensitivity knob and/or by placing opaque weatherproof tape or the lens masks provided on the lower part of the lens.

How are the Time, Sensitivity and Photocell adjusted?

- Time: Sets the time that lights will remain on after the detection zone is vacated from approximately 5 seconds to 12 minutes.
Factory Setting: 5-8 minutes
- Sensitivity: Increases or decreases the responsiveness and range of the sensor (Adjusts from 30% to 100%)
Factory Setting: 100%
- Photocell: Located behind the lens. For night only operation, turn the knob all the way clockwise to (to the moon symbol). For 24 hour operation turn the knob all the way counterclockwise (sun & moon).
Adjust clockwise to have the sensor come on later at dusk, counterclockwise to have it come on earlier.
Factory Setting: Night Only

Control Panel:

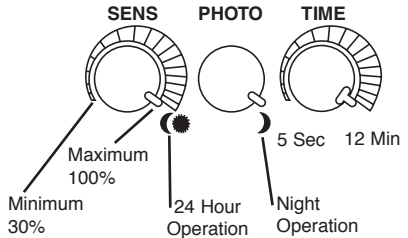

Picking a Location

- Choose a location from which the sensor can “see” all the paths of movement.
- The sensor may be wall or ceiling mounted.
- As distance from the sensor increases, it will take more movement to be detected. For instance, at 10 feet, a half step will be enough, while at 40 feet several steps will be necessary.

How large an area does Stealth200 detect?

The Stealth200 provides a 200° detection pattern. To reduce the angle of coverage on either or both sides, use the plastic blinders provided. The blinders can also be cut sideways and used to reduce low or high detection.

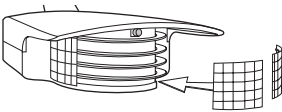

The sensor may be swiveled in any direction to cover the area desired. Always keep the sensor level to ensure full coverage. To reduce coverage, aim the sensor towards the ground.

Stealth STL200 comes with a standard “Double Look Down” Lens. This lens has one “Look Out” zone and two “Look Down” zones, for excellent detection both at long and close range.

How does the LED Detection Indicator work?

The red LED above the lens shows the logic state of the sensor. If the sensor is set for night only operation, the LED will go on for daytime detections without turning on the lights. At night, the LED will be on all the time, except during detections (at which time the controlled lights will go on). At night, the LED serves as a deterrent indicating a security device in operation.

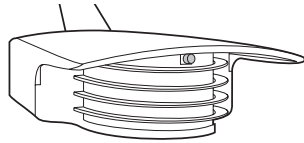

Detection Pattern

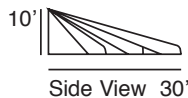
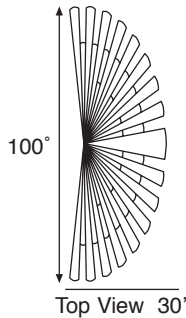

Kit Wiring

Red pigtail is only used to switch remote or additional fixtures.

1. Attach the Universal Mounting bar with the bar screws (provided) to the junction box. If you are attaching your STL200 kit to a surface mount weatherproof box, you must use both gaskets, with the metal mounting plate sandwiched between.

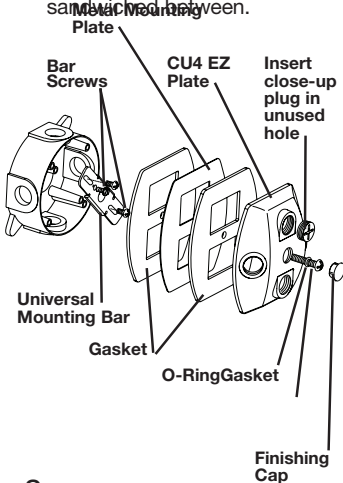

2. Easy Wiring Tip:
Use the "S" shaped Hands Free Hanging Hook to hold the EZ

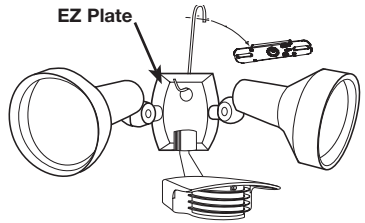
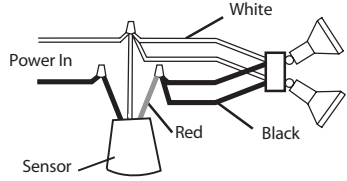

Plate during wiring.

3. Bring power leads and sensor kit leads through holes in all gaskets into junction box.
4. Strip $\frac{1}{2}$ " of insulation from all leads.
5. Attach ground wire(s) to junction box grounding screw. Connect as shown in wiring diagram. See page #6.
6. Twist on wire nuts. Secure with electrical tape.
7. Align gaskets, EZ Plate and metal mounting plate to insure proper seal. Tighten EZ Plate center screw (make sure O-Ring gasket is on the screw) to attach EZ Plate to the box.
8. Insert plastic Finishing Cap in the center of the EZ Plate for a weatherproof seal.
9. Use silicone sealant around all openings to insure a weatherproof seal.
10. Screw in light bulbs. Turn on power. Conduct walk test to adjust

Wiring Diagrams

Basic Wiring Diagram



Basic Kit Wiring

Note: Pigtail is only used to switch remote or additional light fixtures

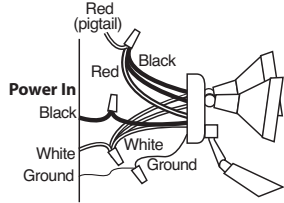

Multiple Fixtures

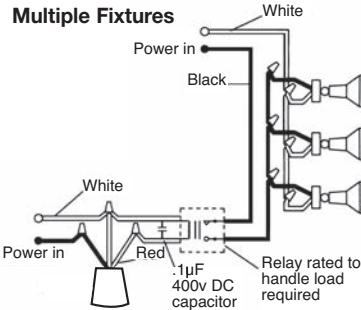

Multiple fixtures may be wired to a single sensor.

To handle loads greater than 1,000 watts, a qualified electrician should install a relay.

Switchplate Label

RAB STEALTH200
To Keep Lights On:
 Switch off-on-off-on within 2 seconds. Resets to Auto Mode at dawn.
To Set Evening Timer:
 To keep lights on for 1-8 hours after dusk, set the Evening Timer knob on the sensor, then flip this switch off-on-off-on-off-on within 3 seconds.
To Resume Auto Mode:
 Switch off for 10 seconds, then back on.

Switchplate label with self-adhesive backing.

Attach Stealth operating instruction label to switchplate for quick and easy reference.

Power Quality

It is not recommended to install sensors on a circuit that also feeds motor loads such as HVAC equipment, kitchen appliances, or garage door openers. The Stealth circuit is surge and transient protected to IEC specifications. However, if voltage varies significantly from 120 volts, sensor may malfunction.

Aiming And Walk Testing

Walk Test

The purpose of the Walk Test is to check and adjust the coverage pattern. Stealth has a 5 minute Test Period which allows the sensor to be aimed and walk tested day or night. If you require 5 more minutes of Test Time, turn the power off for at least 10 seconds and back on again. During the Test Period, the sensor will keep lights on for 5 seconds each time it detects movement in its Detection Zone. The sensor will change to Automatic Mode after 5 minutes of testing.

• To enter Test Mode:

Turn power off for at least 10 seconds and back on.

1. Aim the sensor across the traffic pattern you want to detect. Start by aiming the sensor downward and then raise it slowly until the desired range is obtained.
2. Start outside the pattern and walk across the pattern until the lights go on. As distance from the sensor increases, it will take more movement to be detected.
3. Adjust the sensor aiming as necessary to improve coverage.
4. To adjust the sensitivity turn knob gently. Less sensitivity (counterclockwise) may be desired if you wish to detect a limited area or if the sensor is being activated by wind, foliage or animals. More sensitivity (clockwise) will help cover a larger area.

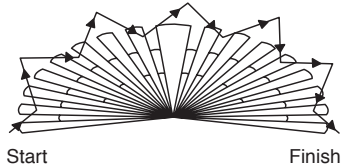

5. Repeat steps #2 thru #4 until you are satisfied with the coverage.
6. The "Time" control is factory set at approximately 5-8 minutes. This period starts after the movement in the detection pattern ceases. If less time is desired, turn the time control counterclockwise. For more time, turn the knob clockwise.
7. Stealth is factory set for night only operation. To obtain 24 hour operation, turn the photocell control full counterclockwise. Intermediate settings will adjust operation during dusk and dawn.
8. Your sensor is ready for operation. See the Technical Tips pages 7-11 if additional help is needed.

Control Panel:

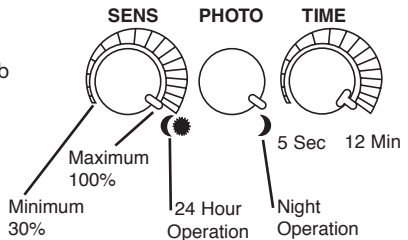

Technical Tips: Lights Do Not Turn Off

1. Make sure that the sensor is not in Manual Override Mode. Turn power OFF for 10 seconds, then ON. Sensor will be in Test Mode for approximately 5 minutes, then it will switch to Auto Mode with lights off and ready to detect movement.

2. Make sure sensor is not aimed at or mounted over something that would move or change temperature such as waving branches, water, air conditioners, windows or heating vents—even on neighboring property. You can test for infrared sources in the area by placing a box or bag over the sensor. Put sensor into test mode. Lights should stay off. Wave your hand inside bag in front of sensor. Lights should go on and then time out. If sensor operates properly when covered, check items #4–7.

Problem: Sensor is triggered by unwanted movement or heat source.

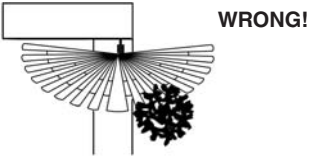

Solution: (1) Aim sensor away from movement or (2) mask lens as in the direction of the source and/or (3) lower sensitivity control setting.

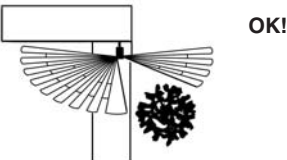

3. Make sure sensor and lights are mounted firmly and do not move even slightly when touched. If they move, tighten all screws.

4. Make sure sensor is not mounted on an unstable object such as a tree or pole that will move in the wind.

Problem:

Movement of tree triggers sensor.

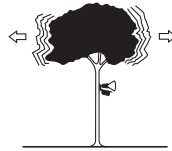

Solution: Mount on stable surface.

5. Was sensor wired hot? If so, circuitry may have been damaged.

6. Make sure sensor is not aimed within 20 feet of a road.

Problem:

Passing cars activate sensor.

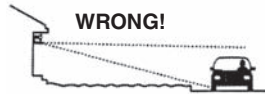

Solution: A 20 foot safety zone and lower sensitivity are recommended to avoid activation from passing cars.



7. Make sure heat from lights is not triggering sensor. Make sure the sensor is below and as far as possible away from lights.

Technical Tips: Lights Turn On and Off Inappropriately

1. Make sure the sensor is installed on its own dedicated circuit, free of motor loads such as HVAC equipment, kitchen appliances or garage door openers.

2. It is not recommended to wire sensors in parallel. More than one sensor wired together makes them difficult to troubleshoot. Disconnect multiple sensors and test separately.

3. Keep all people completely out of the detection pattern to make sure the sensor is not detecting them.

4. Make sure sensor is located below and as far as possible from its lights. Heat from the lights may trigger the sensor.



WRONG!

Solution: Move sensor below and away from the lights.

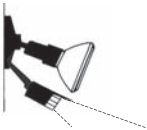

OK!

5. Moths can be attracted to the lights and fly close to the sensor causing triggering. Reducing the sensitivity may help.

6. Make sure sensor is not aimed within 20 feet of a road or sidewalk. Passing cars will activate sensor.

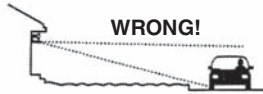

Solution:

A 20 foot safety zone and reduced sensitivity are recommended to avoid activation from passing cars.



OK!

20' Safety Zone

7. Heavy rain, snow or high winds may activate the sensor occasionally. Reduce sensitivity control slightly until problem stops.

8. Make sure lights are not reflecting back into sensor. Check for white or reflective surfaces close to

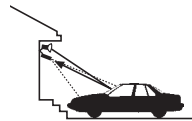

the sensor.

Solution: Aim sensor away from reflective objects, or move the objects and lower sensitivity.

9. Self ballasted PL lamps may cause cycling (on-off).

10. Check Solutions #2, 4, 5, 6, and 7 under "If Lights Do Not Turn Off".⁸

Technical Tips: Lights Do Not Turn On

1. Check that lamps and fixtures work. Compare wiring to the wiring diagram in this manual. Check that the power is on.
2. If installing during daylight, remember that the sensor will provide 5 minutes of Test Time after power is turned on. After 5 minutes, the sensor will switch to Automatic Mode and will not work during daylight if the photocell control is turned to the night only position (moon symbol).

If you require 5 more minutes of Test Time, turn the power off for at least 10 seconds and back on again.

If you require the sensor to operate both day and night, turn the center control knob counterclockwise to the sun and moon symbol.

3. Check that lights from another source, such as adjacent porch lights, garden lights or street lights are not in the sensor's view. The sensor's photocell may detect the light and deactivate "daylight". If you desire the sensor to operate in higher ambient light levels, turn the photocell control (center knob) toward the sun symbol.

4. Was sensor wired hot? If so circuitry may have been damaged.

Lights Turn Off Too Quickly

1. Check if sensor is being "tricked" by reflected light. If lights controlled by the sensor shine or reflect into the photocell (located behind the lens) the unit will go on briefly, see its own light, and turn off "thinking" that it is daytime:

Problems:

Lights reflect into photocell

Lights shine directly into photocell



Solution:

Adjust photocell control (center knob) slightly counterclockwise, to allow operation at higher ambient light levels. Alternatively, move the lights or reflectors or mask the lens in the direction of the lights and/or reflections.

2. Check if "R" lamps, non-reflector "A" lamps or self-ballasted PL lamps are being used in a non-enclosed lampholder. If so, switch to reflector PAR floodlight lamps or Quartz floods so the sensor is not affected by stray light. If using PAR floodlights, consider using lower wattage, energy saving lamps.

Technical Tips: Range Appears Limited

1. Check that the sensor is level from side to side and pointed at the area you desire. If unit is tilted, part of the detection zone may be high in the air over people's heads.



Solution: Position sensor exactly level from side to side.



2. Check that the sensor is not mounted too high. If mounted above 20 feet, much of the usable range will be lost.

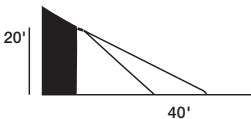

Solution: Mounting at 6 feet to 12 feet allows maximum range.

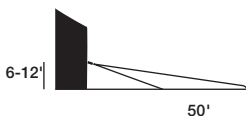

3. Check that movement is not directly towards sensor. Sensor will see movement across its pattern more quickly. To fix, move the sensor.

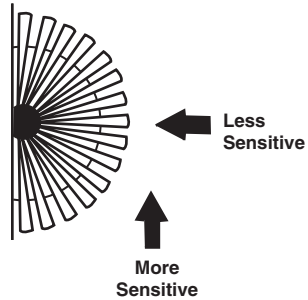

4. Check that movement far away and directly towards sensor is not entirely within one zone.

Problem:

Sensor will not detect until

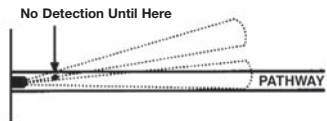

movement crosses zones

Solution:

"Micro Adjust" sensor by moving sideways

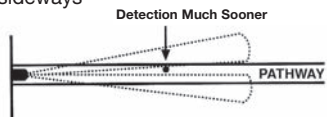

Technical Tips: Lights Turn On for Unknown Reasons

1. Lights may turn on occasionally during rain, snow and windstorms because the sensor is detection changes in temperature.

Solution:

Mount sensor in protected area.

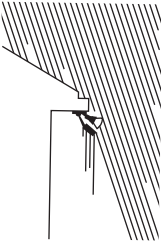

If false detections are a constant problem, reduce sensitivity (turn counterclockwise) until the problem stops.

2. Tilt the sensor lower, it may be seeing distant objects moving.

3. You may not be aware that animals have triggered the sensor. Check sensor aiming to reduce nuisance triggering or mask the lower part of the lens with opaque weatherproof tape or the lens masks provided to create an “Animal Alley”.



4. Although it is surge and transient protected, the sensor may turn on occasionally during extreme voltage surges.

5. A possible source of “mysterious” sensor activations are strong local radio signals. Check for nearby CB, Ham, VHF radio transmitters or Cellular telephones. The sensor may be activated but will not be permanently impaired by these signals.

6. Check all the Solutions mentioned under “Lights Turn On and Off”.

7. Check items #2, 4, 5, 6 and 7 under “Lights Do Not Turn Off.”

Limited Warranty

Your Stealth will be replaced or repaired, at our option, if it proves to be defective in workmanship or materials within ten years from the date of original purchase.

For repair replacement, return the product freight prepaid and insured to:

RAB Lighting
170 Ludlow Avenue
Northvale, NJ 07647

The Stealth should be packed carefully. Please include your sales receipt and a description of the problem.

If your unit is out of warranty or the damage is unrelated to the original manufacture, return your unit directly to us with a check for \$20.00 (made out to RAB Electric). We will repair or replace your unit.

Under no circumstances shall we be liable for any incidental or consequential damages arising out of or in connection with the use or performance of this product or other indirect damages with respect to loss of property or revenue or cost of installation, removal or re-installation. This warranty gives you specific legal rights and you may also have other rights which vary from state to state.

Contents of Accessory Kit

- 2 Lens Masks
- Indoor Switchplate Label
- 3 Wire Nuts

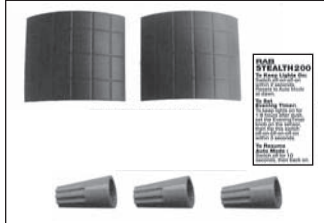

- Crossbar with Green Ground Screw
- Hanging Hook
- 1/2" Close Up Plugs (3)
- Slotted Screws (4)
- Finishing Cap
- O-ring Gasket
- Center Mounting Screw

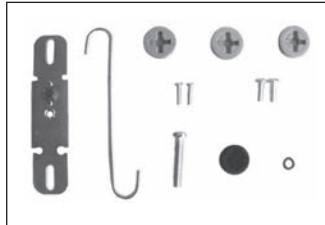

- Foam Gaskets (2)
- Metal Plate



Easy Installation & Product Help

Toll Free Phone

Call our friendly experts.
8AM - 6PM ET Mon. - Fri.
888 RAB-1000

E-mail

Questions and requests
answered promptly
tech@rabweb.com

RAB Lighting
170 Ludlow Avenue
Northvale, New Jersey 07647
U.S.A.

© RAB Lighting 2004

Toll Free Fax

Send faxes to RAB
24/7.
888 RAB-1232

www.rabweb.com

Visit our internet site
for product information

Fax on Demand

Faxed information,
24/7.
888 RAB-1236



