

### Features

- Metal construction.
- One-piece, self-contained ceramic disc valve allows both volume and temperature control.
- Temperature memory allows faucet to be turned on and off at any temperature setting.
- High-temperature limit setting for added safety.
- 1.8 gal/min (6.8 l/min) maximum flow rate at 60 psi (4.1 bar).
- Meets CalGreen requirements for kitchen faucets.
- Lower flow kit or higher flow kit is available.
- MasterClean™ spray nozzles prohibit mineral buildup for easy cleaning.
- Swing spout with integral pullout spray and hose.
- Touch control for stream-to-spray water flow.
- 10-1/8" (257 mm) swing spout reach.
- ProMotion® technology's light, quiet braided hose and ball joint make the pull-down sprayhead easier and more comfortable to use.
- Includes parts for both single-hole and three-hole installations.

### Optional Accessories

1012715 Kitchen Faucet Deep Rough-In Kit  
1177879  
1177880



ADA CSA B651 OBC

### Codes/Standards

ASME A112.18.1/CSA B125.1  
NSF 61  
NSF 372  
DOE - Energy Policy Act 1992  
ADA  
ICC/ANSI A117.1  
CSA B651  
OBC







All applicable US Federal and State material regulations

### KOHLER® Faucet Lifetime Limited Warranty

See website for detailed warranty information.

### Available Color/Finishes

*Color tiles intended for reference only.*

Color	Code	Description
	CP	Polished Chrome
	AF	Vibrant® French Gold
	G	Brushed Chrome
	BN	Vibrant® Brushed Nickel
	VS	Vibrant® Stainless
	BV	Vibrant® Brushed Bronze

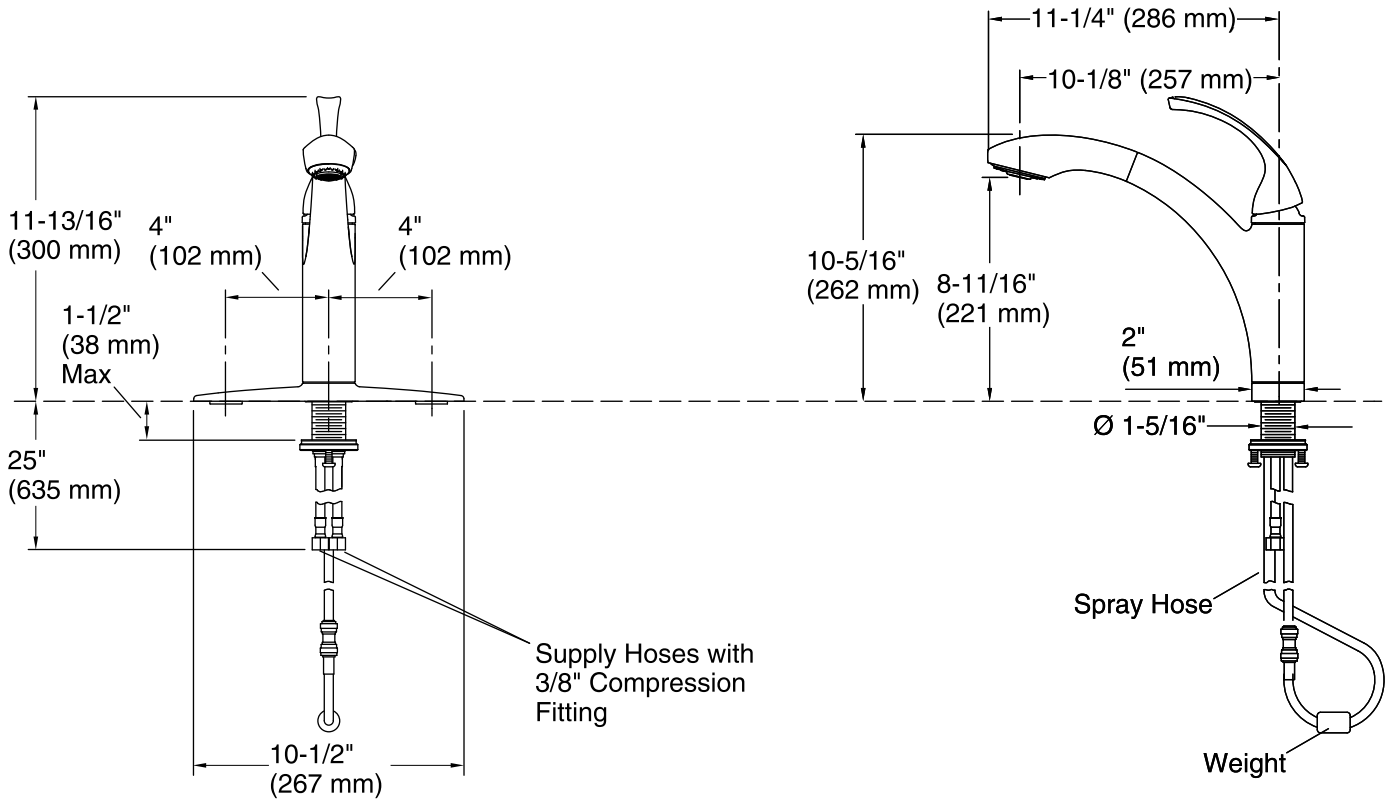

### Technical Information

All product dimensions are nominal.

Spout reach: 10-1/8" (257 mm)

### Faucet:

Flow rate: 1.8 gal/min (6.8 l/min)

Pressure: 45 psi (3.1 bar)

### Notes

Install this product according to the installation guide.

Lower flow kit or higher flow kit is available.

Faucet contains all necessary parts for both single-hole and three-hole installations.

The deep roughing-in kit (1012715) is designed for a mounting surface 1-3/8" (35 mm) to 3-3/8" (86 mm) thick. The faucet mounting hole should be between 1-7/16" (37 mm) to 1-1/2" (38 mm) in diameter.

ADA, OBC, CSA B651 compliant when installed to the specific requirements of these regulations.