

### Features

- Metal construction.
- Brass valve bodies.
- Pop-up drain with lift rod and tailpiece.
- 5-1/2" (140 mm) spout reach.
- Stationary spout.
- For 8" (203 mm) or 16" (406 mm) centers.
- Quarter-turn washerless ceramic disc valves.
- Cross handles.
- Low gooseneck spout.
- 1.5 gal/min (5.7 l/min) maximum flow rate [max at 60 psi (4.14 bar)].



ADA

### Codes/Standards

ASME A112.18.1/CSA B125.1

NSF 61

NSF 372

DOE - Energy Policy Act 1992

EPA WaterSense®

ADA

ICC/ANSI A117.1







All applicable US Federal and State material regulations

### KOHLER® Faucet Lifetime Limited Warranty

See website for detailed warranty information.

### Available Color/Finishes

*Color tiles intended for reference only.*

Color	Code	Description
	CP	Polished Chrome
	SN	Vibrant® Polished Nickel
	AF	Vibrant® French Gold
	G	Brushed Chrome
	BN	Vibrant® Brushed Nickel
	BV	Vibrant® Brushed Bronze

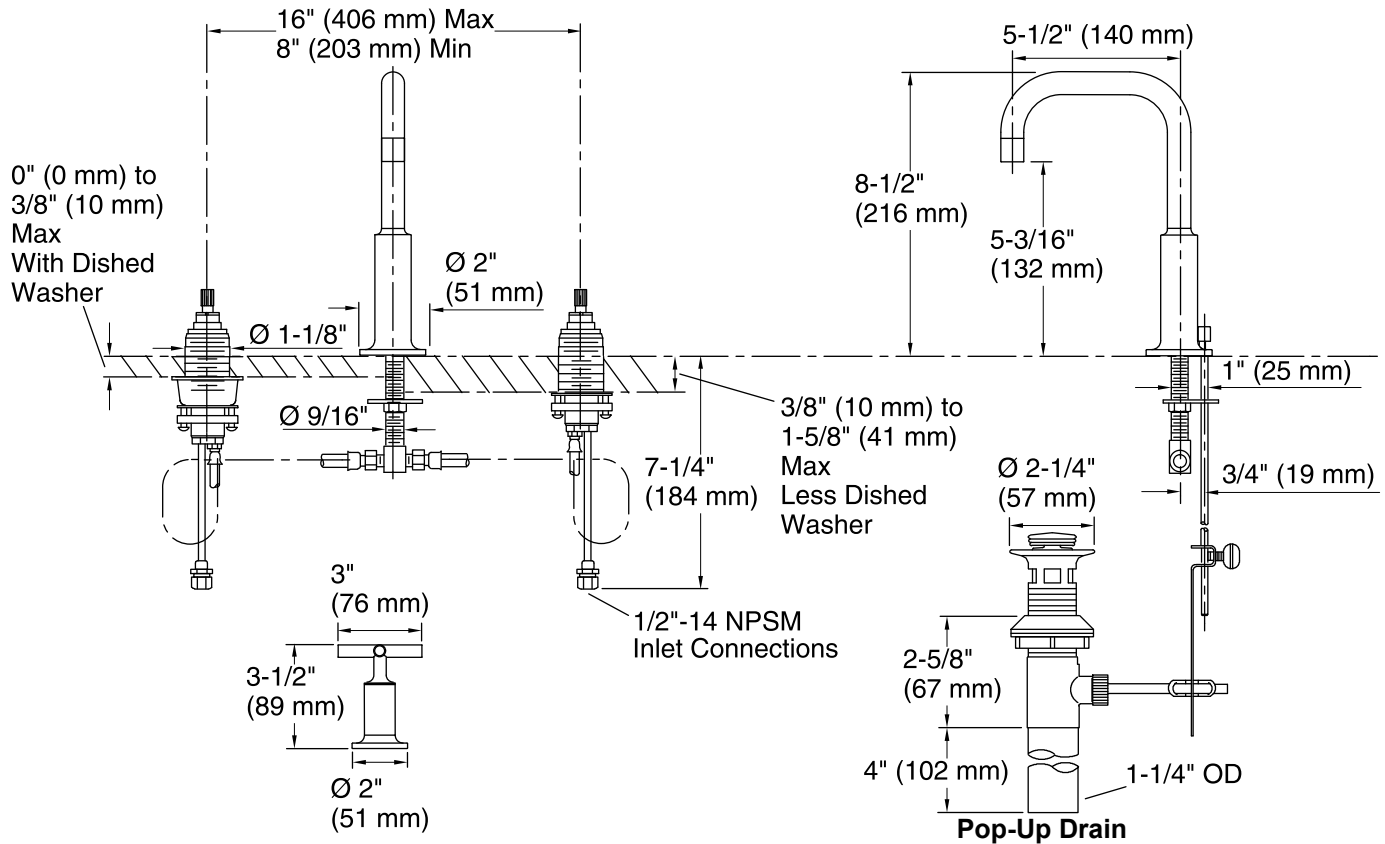

### Technical Information

All product dimensions are nominal.

Spout reach: 5-1/2" (140 mm)

Drain included: YES

Drain tailpiece included: YES

### Faucet:

Flow rate: 1.5 gal/min (5.7 l/min)

Pressure: 60 psi (4.1 bar)

### Notes

Install this product according to the installation guide.

ADA compliant when installed to the specific requirements of these regulations.