

Features

- Metal construction.
- Brass valve bodies.
- Quarter-turn washerless ceramic disc valves.
- Lower flow aerator options are available (refer to the Kohler Price Book).
- Metal pop-up drain with lift rod and tailpiece.
- Lever handles.
- For 8" (203 mm) or 16" (406 mm) centers.
- 6-3/8" (162 mm) spout reach.
- 1.5 gal/min (5.7 l/min) maximum flow rate [max at 60 psi (4.14 bar)].



ADA **CSA B651** **OBC**

Codes/Standards







ASME A112.18.1/CSA B125.1
NSF 61
NSF 372
DOE - Energy Policy Act 1992
EPA WaterSense®
ADA
ICC/ANSI A117.1
CSA B651
OBC

KOHLER® Faucet Lifetime Limited Warranty

See website for detailed warranty information.

Available Color/Finishes

Color tiles intended for reference only.

Color	Code	Description
	CP	Polished Chrome
	SN	Vibrant® Polished Nickel
	PB	Vibrant® Polished Brass
	G	Brushed Chrome
	BN	Vibrant® Brushed Nickel
	BV	Vibrant® Brushed Bronze
	BX	Vibrant® Brazen Bronze
	CB	Polished Chrome with Vibrant® Polished Brass Accents

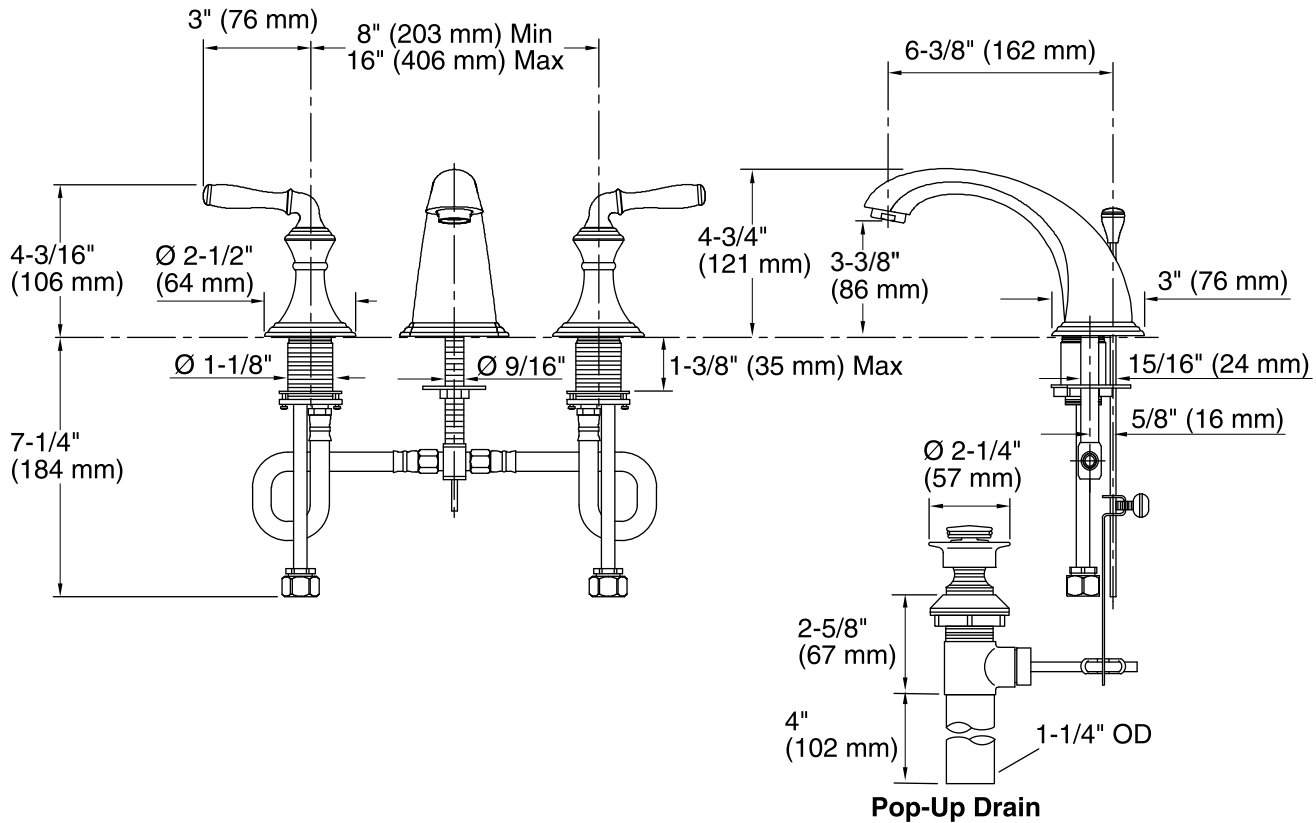

Technical Information

All product dimensions are nominal.

Spout reach: 6-3/8" (162 mm)

Drain tailpiece included: YES

Faucet:

Flow rate: 1.5 gal/min (5.7 l/min)

Pressure: 60 psi (4.1 bar)

Notes

Install this product according to the installation guide.

ADA, OBC, CSA B651 compliant when installed to the specific requirements of these regulations.