



### Features

- End drain.
- Slotted overflow for deep soaking.
- Coordinates with other products in the Archer® collection.
- 60" (1524 mm) x 32" (813 mm) x 19" (483 mm)

### Material

- Acrylic

### Hydrotherapy

- Pump with air switch for whirlpool.
- Single-speed whirlpool offers eight fully adjustable hydro-massage jets for water flow and direction.
- Built-in 1500 W heater.



### Installation

- Drop-in

### Required Accessories

K- 7271 Brass Slotted Overflow Bath Drain

or

K- 7272 PVC Slotted Overflow Bath Drain

### Recommended Accessories

K- 24916 Wireless Music Kit

**ADA**

### Codes/Standards

ASME A112.19.7/CSA B45.10

CSA B45.5/IAPMO Z124

UL 1795

Greenguard UL 2818 - Gold

ADA











ICC/ANSI A117.1

### KOHLER® One-Year Limited Warranty

See website for detailed warranty information.

### Available Color/Finishes

*Color tiles intended for reference only.*

| Color  | Code | Description   |
|--|------|---------------|
|  | 0    | White         |
|  | 96   | Biscuit       |
|  | 47   | Almond        |
|  | NY   | Dune          |
|  | 95   | Ice™ Grey     |
|  | G9   | Sandbar       |
|  | 33   | Mexican Sand™ |
|  | K4   | Cashmere      |
|  | 58   | Thunder™ Grey |
|  | 7    | Black Black™  |

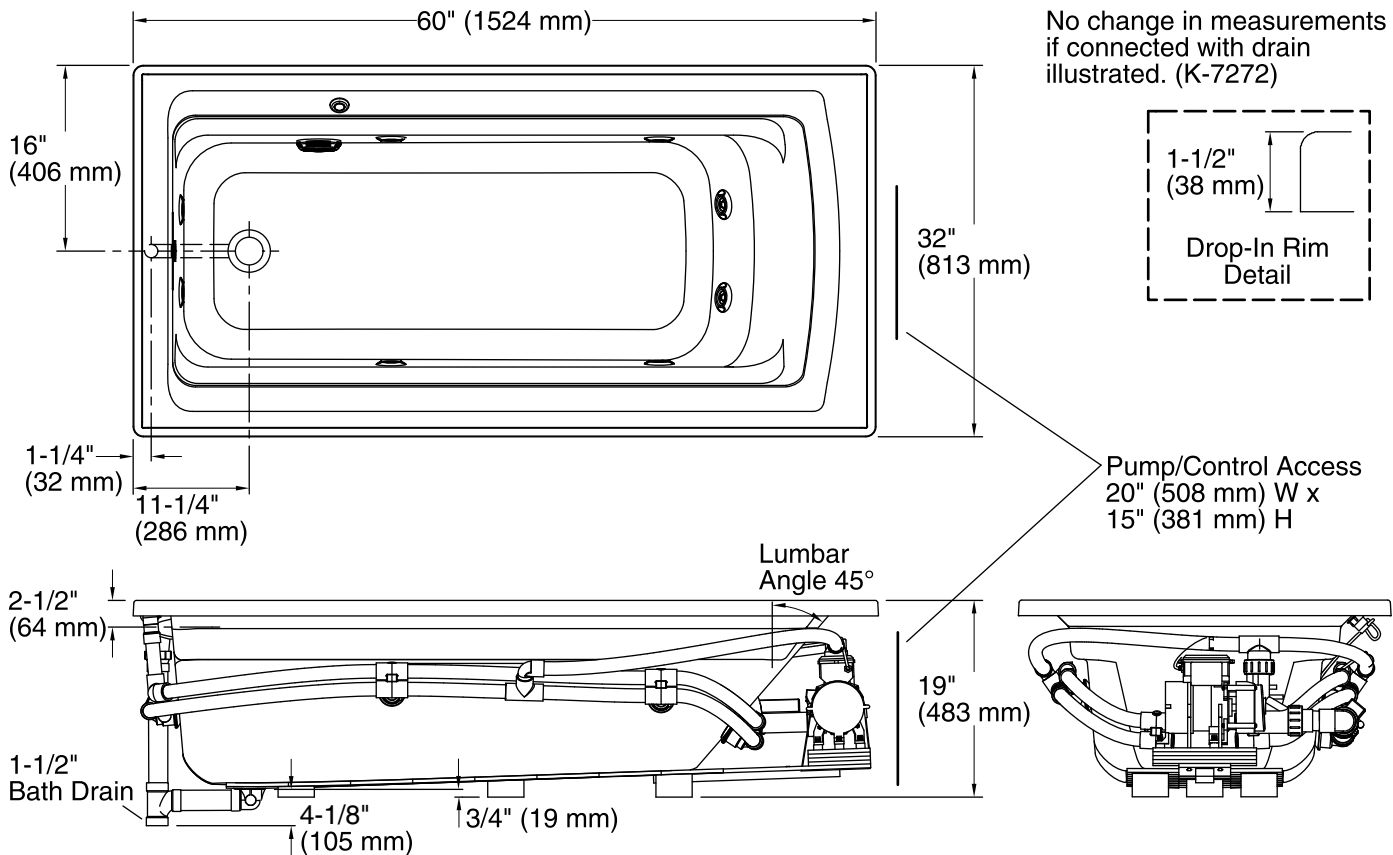

### Required Electrical Service

Two dedicated circuits required, protected with Class A Ground-Fault Circuit-Interrupter (GFCI) or Residual Current Device (RCD).

Pump: 120 V, 15 A, 60 Hz  
Heater: 120 V, 15 A, 60 Hz

### Technical Information

All product dimensions are nominal.

Installation: Drop-in  
Drain location: End  
Basin area, bottom: 45-1/8" x 19-11/16" (1146 mm x 500 mm)  
Basin area, top: 52-3/4" x 25-5/16" (1340 mm x 643 mm)  
Weight: 110 lbs (49.9 kg)  
Minimum floor load: 46 lbs/ft<sup>2</sup> (224.6 kg/m<sup>2</sup>)  
Water depth: 15" (381 mm)  
Water capacity: 58 gal (219.6 L)  
Cutout: Drop-in, 58-1/2" x 30-1/2" (1486 mm x 775 mm)  
Electrical component rating: Pump: 120 V, 7 A, 60 Hz  
Heater: 120 V, 12.5 A, 60 Hz, 1500 W  
Pump speed: Single

### Notes

Measure your actual product for rough-in details.

Install this product according to the installation instructions.

The hot water supply should be 70% of the capacity of the bath or greater. Installations will vary.

Provide one grounded electrical outlet within 24" (610 mm) of each component.

This product is designed for drop-in installation only. It is not suited for use in a three-wall alcove with an overhead shower.

ADA compliant when installed to the specific requirements of these regulations.