



Features

- Corner layout minimizes footprint without compromising bathing area.
- Center drain.
- Integral lumbar support and armrests for comfort.
- 54" (1372 mm) x 54" (1372 mm) x 20" (508 mm)

Material

- Acrylic

Hydrotherapy

- Single-speed whirlpool offers six fully adjustable hydro-massage jets for water flow and direction.
- Pump with air switch for whirlpool.
- Multiple pump location options give you more choices for installation and access.

Installation

- Drop-in

Recommended Accessories

- K- 11677 Bath Drain
- K- 1491 Bath/Whirlpool Pillow
- K- 1601 Bath/Whirlpool Footstop
- K- 7213 27" Cable Bath Drain
- K- 7214 27" Cable Bath Drain
- K- 9696 Whirlpool 6-Jet Trim Kit
- K- 24916 Wireless Music Kit



Codes/Standards



ASME A112.19.7/CSA B45.10
CSA B45.5/IAPMO Z124
ASTM E162
ASTM E662
UL 1795
Greenguard UL 2818 - Gold
CARB P2

KOHLER® One-Year Limited Warranty

See website for detailed warranty information.

Available Color/Finishes

Color tiles intended for reference only.

Color	Code	Description
	0	White
	96	Biscuit
	47	Almond

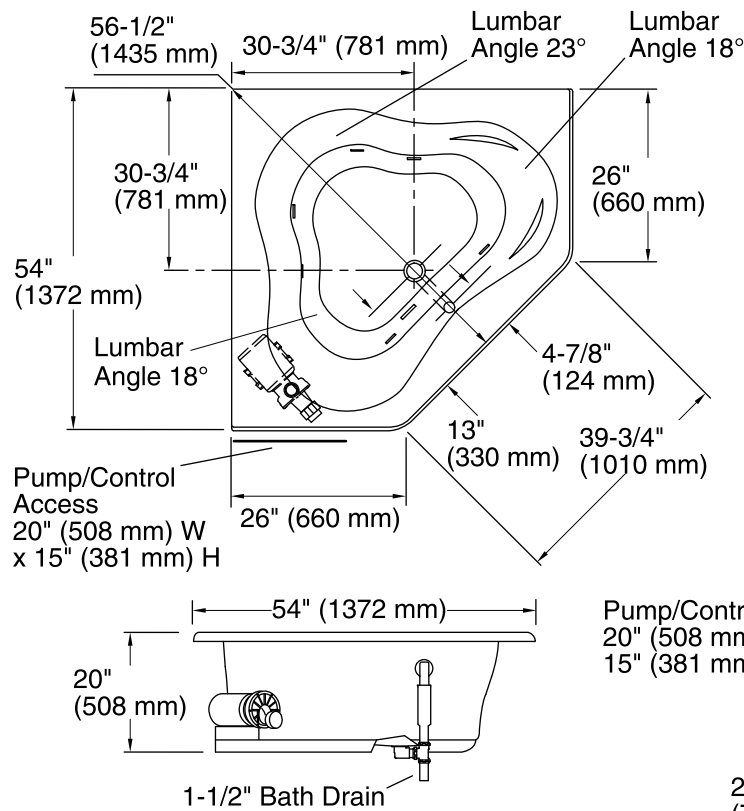

No change in measurements if connected with drain illustrated. (K-7161-AF)

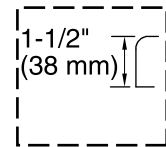

Drop-In Rim Detail

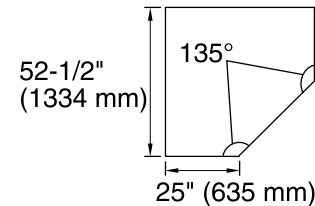

Cut-Out Detail

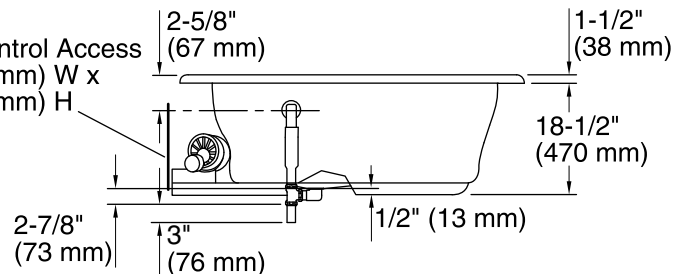

Required Electrical Service

One dedicated circuit required, protected with Class A Ground-Fault Circuit-Interrupter (GFCI) or Residual Current Device (RCD).

Pump: 120 V, 15 A, 60 Hz

Technical Information

All product dimensions are nominal.

Installation: Drop-in, Corner
 Drain location: Center
 Basin area, bottom: 44" x 36" (1118 mm x 914 mm)
 Basin area, top: 56" x 43" (1422 mm x 1092 mm)
 Weight: 65 lbs (29.5 kg)
 Minimum floor load: 37 lbs/ft² (180.6 kg/m²)
 Water depth: 15" (381 mm)
 Water capacity: 76 gal (287.7 L)
 Electrical component rating: Pump: 120 V, 7.5 A, 60 Hz
 Pump speed: Single

Notes

Measure your actual product for rough-in details.

Install this product according to the installation instructions.

The hot water supply should be 70% of the capacity of the bath or greater. Installations will vary.

Provide one grounded electrical outlet within 24" (610 mm) of each component.