



### Features

- End drain.
- Slotted overflow for deep soaking.
- Integral lumbar support.
- 66" (1676 mm) x 32" (813 mm) x 22" (559 mm)

### Material

- Acrylic

### Hydrotherapy

- 122 BubbleMassage™ airjets. 18 levels of massage intensity.
- Zones of Control feature allows you to target massage to back, midsection, or feet.
- Automatic purge cycles remove residual water from air channels after use.
- Built-in 300 W heater.
- Lighted keypad control.

### Installation

- Drop-in or under-mount.

### Required Accessories

K- 7271 Brass Slotted Overflow Bath Drain

or

K- 7272 PVC Slotted Overflow Bath Drain

### Recommended Accessories

K- 1491 Bath/Whirlpool Pillow

K- 1601 Bath/Whirlpool Footstop

K- 1703 Whirlpool Remote Control

K- 550 Under-mount Installation Kit

K- 9498 3" Keypad Trim

K- 24916 Wireless Music Kit



### Codes/Standards

ASME A112.19.7/CSA B45.10

CSA B45.5/IAPMO Z124

ASTM E162

ASTM E662

UL 1795











Greenguard UL 2818 - Gold

### KOHLER® One-Year Limited Warranty

See website for detailed warranty information.

### Available Color/Finishes

*Color tiles intended for reference only.*

Color	Code	Description
	0	White
	96	Biscuit
	47	Almond
	NY	Dune
	95	Ice™ Grey
	G9	Sandbar
	33	Mexican Sand™
	K4	Cashmere
	58	Thunder™ Grey
	7	Black Black™

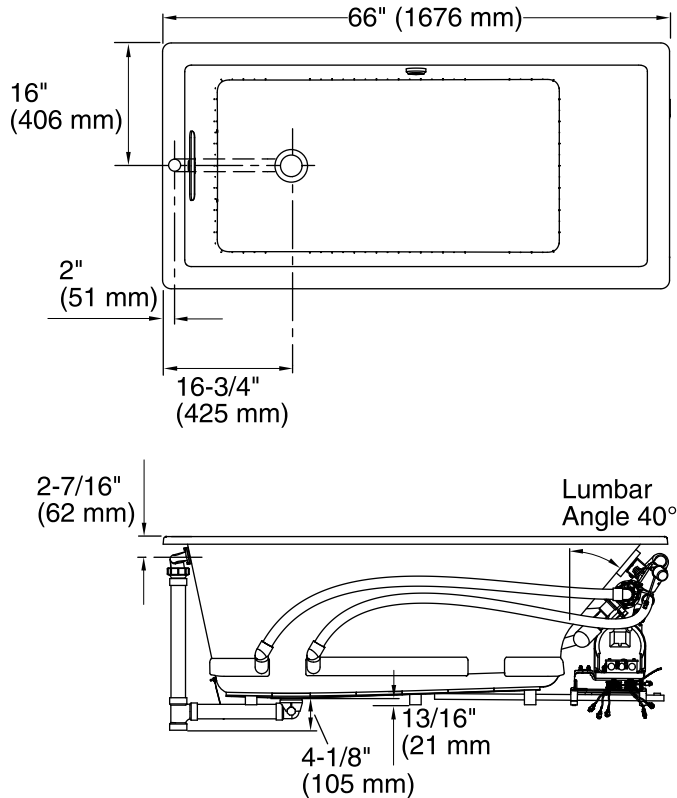

No change in measurement if connected with drain illustrated. (K-7272)

Blower Motor/Control Access  
 30" (762 mm) W x  
 15" (381 mm) H Min

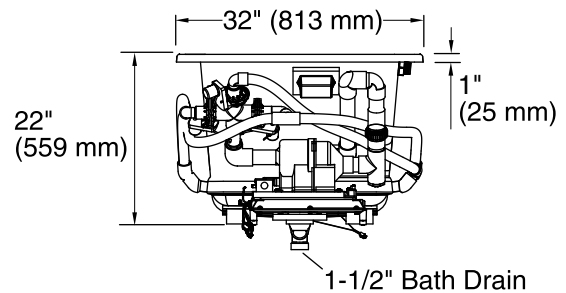

### Required Electrical Service

One dedicated circuit required, protected with Class A Ground-Fault Circuit-Interrupter (GFCI) or Residual Current Device (RCD).

Blower: 240 V, 15 A, 50/60 Hz

### Technical Information

All product dimensions are nominal.

Installation:	Drop-in, Under-mount
Drain location:	End
Basin area, bottom:	44-1/2" x 22-5/16" (1130 mm x 567 mm)
Basin area, top:	59-5/8" x 25-1/2" (1514 mm x 648 mm)
Weight:	111 lbs (50.3 kg)
Minimum floor load:	50 lbs/ft <sup>2</sup> (244.1 kg/m <sup>2</sup> )
Water depth:	18" (457 mm)
Water capacity:	85.8 gal (324.8 L)
Cutout:	Drop-in, 64-1/2" x 30-1/2" (1638 mm x 775 mm)
Electrical component rating:	Blower: 240 V, 5 A, 50/60 Hz, 300 W

### Notes

Measure your actual product for rough-in details.

Install this product according to the installation instructions.

The hot water supply should be 70% of the capacity of the bath or greater. Installations will vary.

If relocating the blower motor, do not relocate or alter the PVC tee or coiled flexible tubing connected to the blower. Follow the blower relocation instructions exactly. Provide access for servicing the blower.