



Features

- Integral flange.
- Slotted overflow for deep soaking.
- Left drain.
- Integral apron with removable access panel.
- Integral lumbar support.
- Coordinates with other products in the Archer® collection.
- 60" (1524 mm) x 30" (762 mm) x 19" (483 mm)

Material

- Acrylic

Hydrotherapy

- Single-speed whirlpool offers eight fully adjustable hydro-massage jets for water flow and direction.
- Pump with air switch for whirlpool.

Installation

- Alcove

Required Accessories

K- 7271 Brass Slotted Overflow Bath Drain

or

K- 7272 PVC Slotted Overflow Bath Drain

Recommended Accessories

K- 24916 Wireless Music Kit



ADA

Codes/Standards











ASME A112.19.7/CSA B45.10
CSA B45.5/IAPMO Z124
UL 1795
CSA C22.2 No. 218.2
Greenguard UL 2818 - Gold
ADA
ICC/ANSI A117.1
CARB P2

KOHLER® One-Year Limited Warranty

See website for detailed warranty information.

Available Color/Finishes

Color tiles intended for reference only.

Color	Code	Description
	0	White
	96	Biscuit
	47	Almond
	NY	Dune
	95	Ice™ Grey
	G9	Sandbar
	33	Mexican Sand™
	K4	Cashmere
	58	Thunder™ Grey
	7	Black Black™

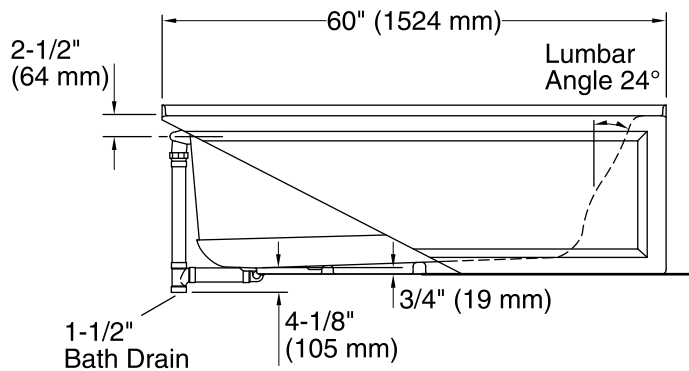
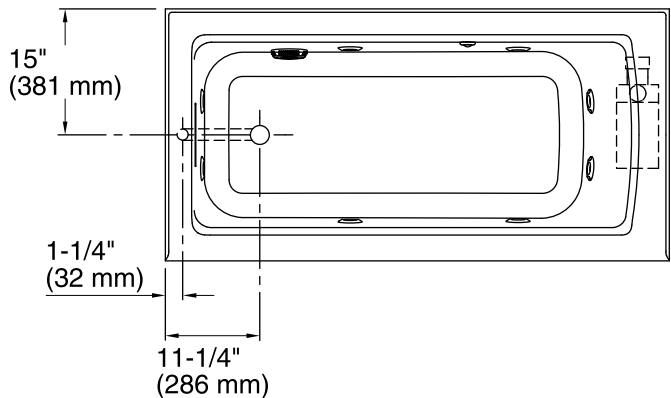

No change in measurements if connected with drain illustrated. (K-7272)

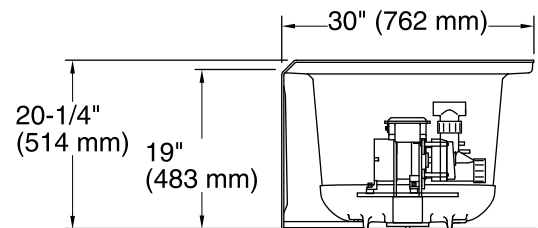
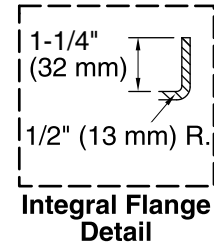

Required Electrical Service

One dedicated circuit required, protected with Class A Ground-Fault Circuit-Interrupter (GFCI) or Residual Current Device (RCD).

Pump: 120 V, 15 A, 60 Hz

Technical Information

All product dimensions are nominal.

Installation: 3-Wall Alcove
 Drain location: Left
 Basin area, bottom: 45-1/8" x 19-11/16" (1146 mm x 500 mm)
 Basin area, top: 52-1/8" x 22-1/16" (1324 mm x 560 mm)
 Weight: 113 lbs (51.3 kg)
 Minimum floor load: 49 lbs/ft² (239.2 kg/m²)
 Water depth: 15-1/8" (384 mm)
 Water capacity: 57 gal (215.8 L)
 Electrical component rating: Pump: 120 V, 7 A, 60 Hz
 Pump speed: Single

Notes

Measure your actual product for rough-in details.

Install this product according to the installation instructions.

The hot water supply should be 70% of the capacity of the bath or greater. Installations will vary.

Provide one grounded electrical outlet within 24" (610 mm) of each component.

ADA compliant when installed to the specific requirements of these regulations.