

Features

- Wall-mount
- Single hole faucet drilling.
- With overflow.
- Drilled for concealed arm carrier.
- Soap dispenser hole on left.

Material

- Vitreous china.

Recommended Accessories

K- 8998 P-Trap

Components

Additional included component/s: Hanger (2 Required).



ADA

CSA B651

OBC

Codes/Standards

ASME A112.19.2/CSA B45.1

ADA

ICC/ANSI A117.1

CSA B651

OBC





All applicable US Federal and State material regulations

KOHLER® One-Year Limited Warranty

See website for detailed warranty information.

Available Color/Finishes

Color tiles intended for reference only.

Color	Code	Description
	0	White
	96	Biscuit
	47	Almond
	7	Black Black™

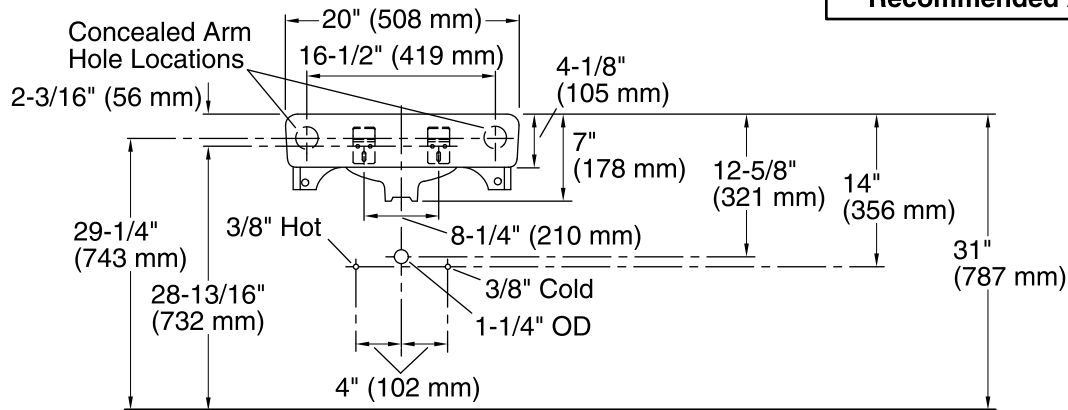
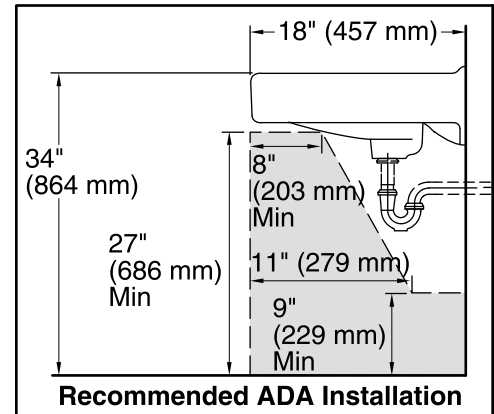
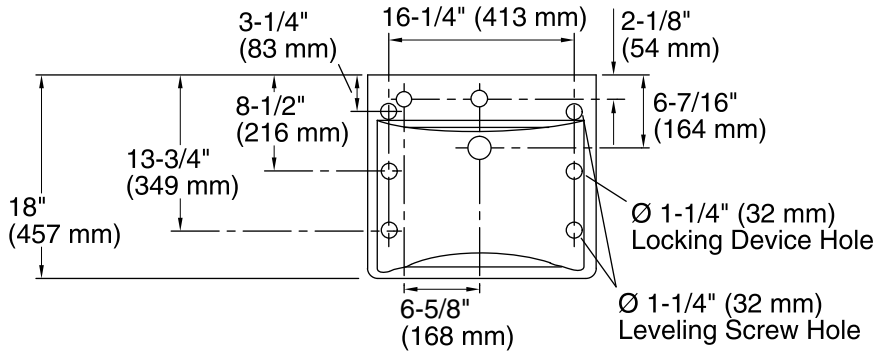

Standard Installation

Technical Information

All product dimensions are nominal.

Bowl configuration:	Single
Installation:	Wall-mount
Bowl area (Only)	Length: 18" (457 mm) Width: 13" (330 mm) With overflow: Yes Water depth: 4-7/8" (124 mm)
Bowl area	With overflow: Yes
Number of deck holes:	1
Faucet hole(s):	1-3/8" (35 mm)
Soap/Lotion hole:	1-1/4" (32 mm)
Drain hole:	1-3/4" (44 mm)

Notes

Install this product according to the installation guide.

ADA, OBC, CSA B651 compliant when installed to the specific requirements of these regulations.