

### Features

- Vitreous china.
- Under-mount
- With overflow.
- Without faucet holes.
- Includes 1193643 clamp assembly.
- 19-7/8" (505 mm) x 15-5/16" (389 mm) x 7-1/2" (191 mm)

### Recommended Accessories

K- 8998 P-Trap

### Components

Additional included component/s: Basin clamp assembly.



ADA

### Codes/Standards

ASME A112.19.2/CSA B45.1

ADA

ICC/ANSI A117.1











All applicable US Federal and State material regulations

### KOHLER® One-Year Limited Warranty

See website for detailed warranty information.

### Available Color/Finishes

*Color tiles intended for reference only.*

Color	Code	Description
	0	White
	96	Biscuit
	47	Almond
	NY	Dune
	95	Ice™ Grey
	G9	Sandbar
	33	Mexican Sand™
	K4	Cashmere
	58	Thunder™ Grey
	7	Black Black™

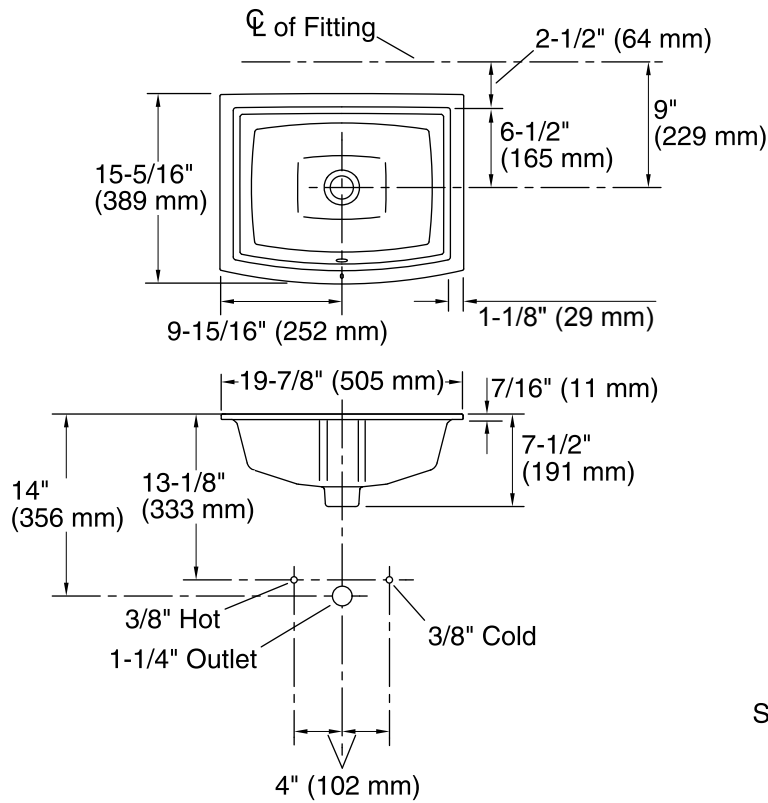

**Standard Installation**

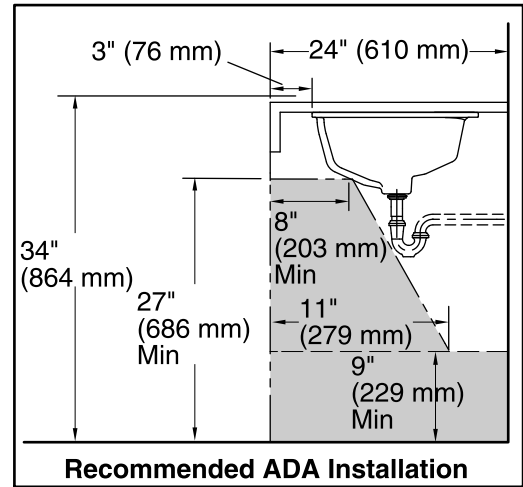

**Recommended ADA Installation**

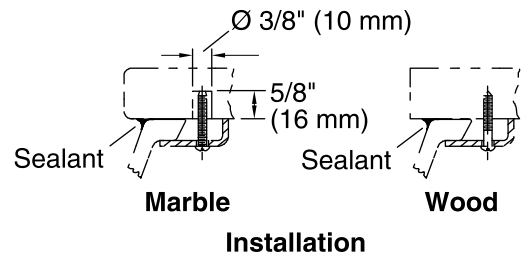

### Technical Information

All product dimensions are nominal.

Bowl configuration:	Single
Installation:	Under-mount
Bowl area (Only)	Length: 17-5/8" (448 mm) Width: 13" (330 mm) With overflow: Yes Water depth: 3-3/4" (95 mm)
Bowl area	With overflow: Yes
Drain hole:	1-3/4" (44 mm)
Template:	Under-mount, 1224722-7, required, not included

### Notes

Install this product according to the installation guide.

**NOTICE:** Countertop manufacturer or cutter must use the cut-out template provided with the product, or a current one provided by Kohler Co. (call 1-800-4-KOHLER). Kohler Co. is not responsible for cutout errors when the incorrect cut-out template is used.

ADA compliant when installed to the specific requirements of these regulations.