

Features

- Dual control wall-mounted.
- Lever handles.
- Stationary spout.
- Less drain.
- 6-1/4" (159 mm) 35° spout from wall to center of drain.
- 1.5 gal/min (5.7 l/min) maximum flow rate [max at 60 psi (4.14 bar)].

Material

- Brass construction.

Required Accessories

K- 410-K Wall-mount Valve

Optional Accessories

K- 7107 Decorative Drain
K- 7108 Decorative Drain
K- 7114 Pop-Up Drain
K- 7124 Pop-Up Clicker Drain
K- 7127 Drain
K- 7129 Drain



ADA

Codes/Standards







ASME A112.18.1/CSA B125.1
NSF 61
NSF 372
DOE - Energy Policy Act 1992
EPA WaterSense®
ADA
ICC/ANSI A117.1
All applicable US Federal and State material regulations

KOHLER® Faucet Lifetime Limited Warranty

See website for detailed warranty information.

Available Color/Finishes

Color tiles intended for reference only.

Color	Code	Description
	CP	Polished Chrome
	SN	Vibrant® Polished Nickel
	AF	Vibrant® French Gold
	G	Brushed Chrome
	BN	Vibrant® Brushed Nickel
	BV	Vibrant® Brushed Bronze

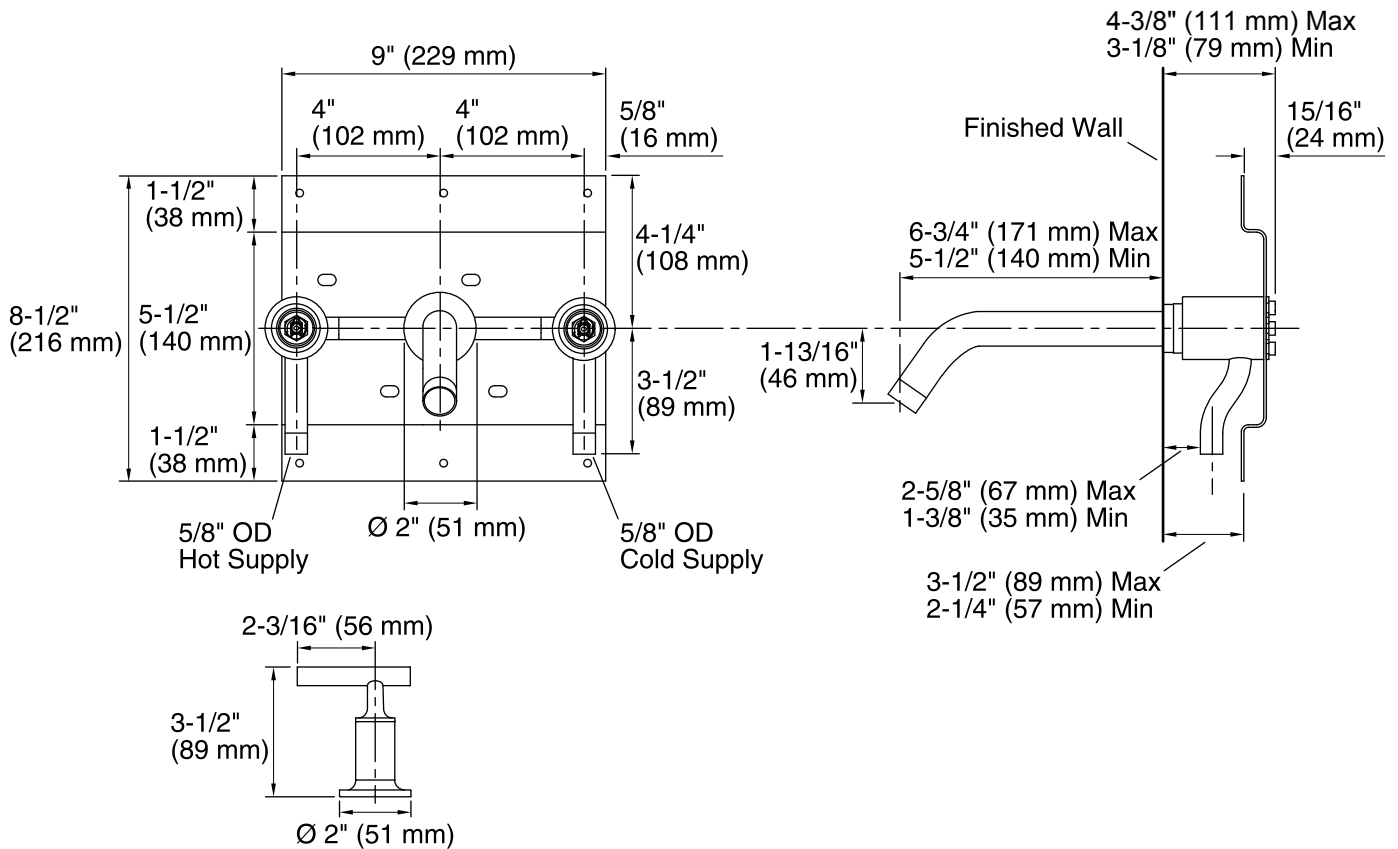

Technical Information

All product dimensions are nominal.

Spout reach: 6-3/4" (171 mm)

Faucet:

Flow rate: 1.5 gal/min (5.7 l/min)

Pressure: 60 psi (4.1 bar)

Notes

Install this product according to the installation guide.

The distance between the bottom of spout and top of the fixture rim must not be less than 1-1/2" (38 mm) and not greater than 6" (152 mm).

Three 1-1/2" (38 mm) diameter cutout holes are required for spout and handles.

ADA compliant when installed to the specific requirements of these regulations.