

Features

- 33-inch minimum base cabinet width.
- KOHLER cast iron.
- Acid-resistant enamel finish.
- Top-mount.
- Single compartment.
- Three faucet holes with one accessory hole to the right.
- 33" (838 mm) x 22" (559 mm).

Recommended Accessories

K- 9000 P-Trap

Optional Accessories

K- 6063 Sink Rack
K- 6637 Cutting Board
K- 8801 Sink Strainer



Codes/Standards











ASME A112.19.1/CSA B45.2

KOHLER® Enameled Cast Iron Kitchen Sink - Lifetime Limited Warranty

See website for detailed warranty information.

Available Color/Finishes

Color tiles intended for reference only.

Color	Code	Description
	0	White
	FF	Sea Salt™
	96	Biscuit
	47	Almond
	FD	Cane Sugar™
	95	Ice™ Grey
	G9	Sandbar
	K4	Cashmere
	20	Suede
	KA	Black 'n Tan
	7	Black Black™

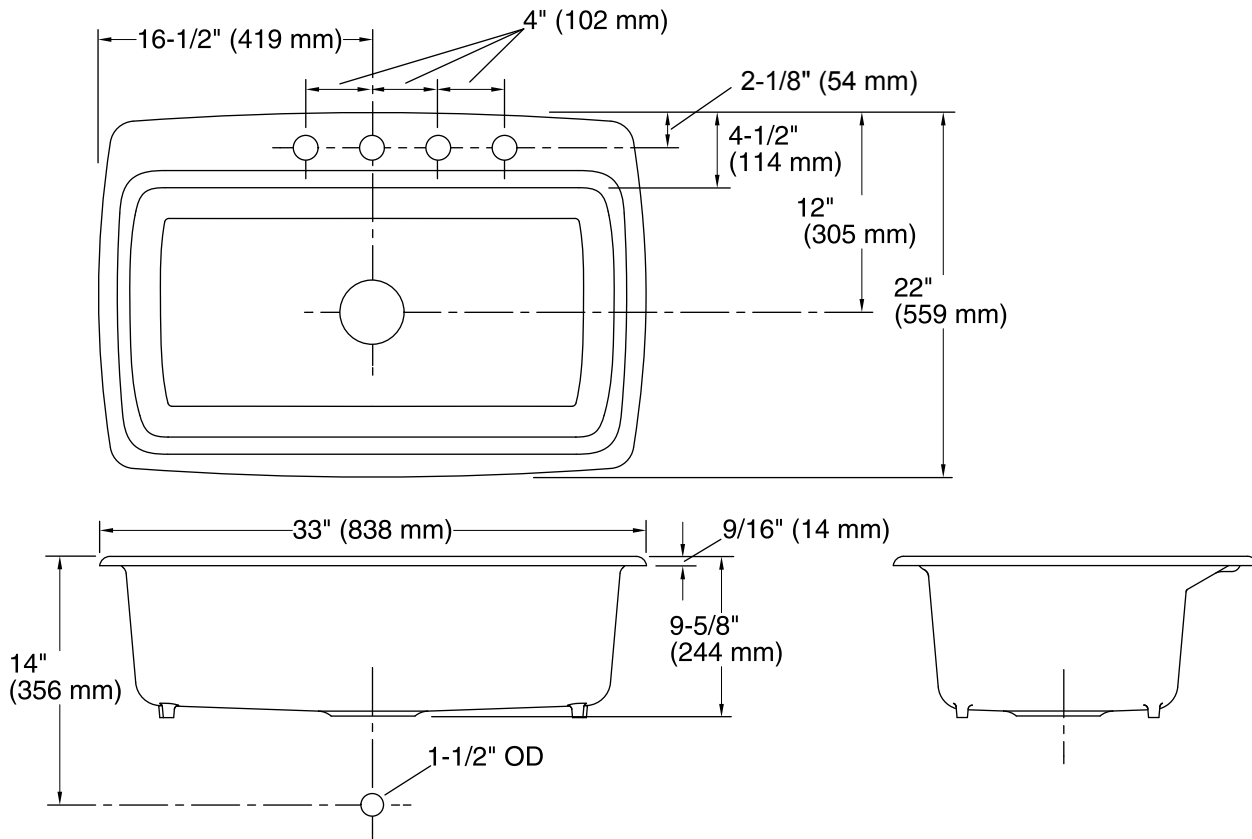

Technical Information

All product dimensions are nominal.

Bowl configuration:	Single
Installation:	Top-mount
Cutout:	Top-mount, 30-1/2" x 20-1/8" (775 mm x 511 mm) with 1-1/2" (38 mm) radius corners
Bowl area	Length: 29" (737 mm) Width: 15" (381 mm) Bowl depth: 9" (229 mm)
Number of deck holes:	4
Faucet hole(s):	1-3/8" (35 mm)
Drain hole:	3-5/8" (92 mm)

Notes

Install this product according to the installation guide.