

Features

- Right-hand trip lever.
- Premium metal construction for durability.
- KOHLER finishes resist corrosion and tarnish.
- For use with the Memoirs Comfort Height toilet.
- Coordinates with other products in the Memoirs Collection.



ADA

Codes/Standards







ASME A112.18.1/CSA B125.1
ADA
ICC/ANSI A117.1

KOHLER® One-Year Limited Warranty

See website for detailed warranty information.

Available Color/Finishes

Color tiles intended for reference only.

Color	Code	Description
	SN	Vibrant® Polished Nickel
	AF	Vibrant® French Gold
	PB	Vibrant® Polished Brass
	G	Brushed Chrome
	BN	Vibrant® Brushed Nickel
	BV	Vibrant® Brushed Bronze

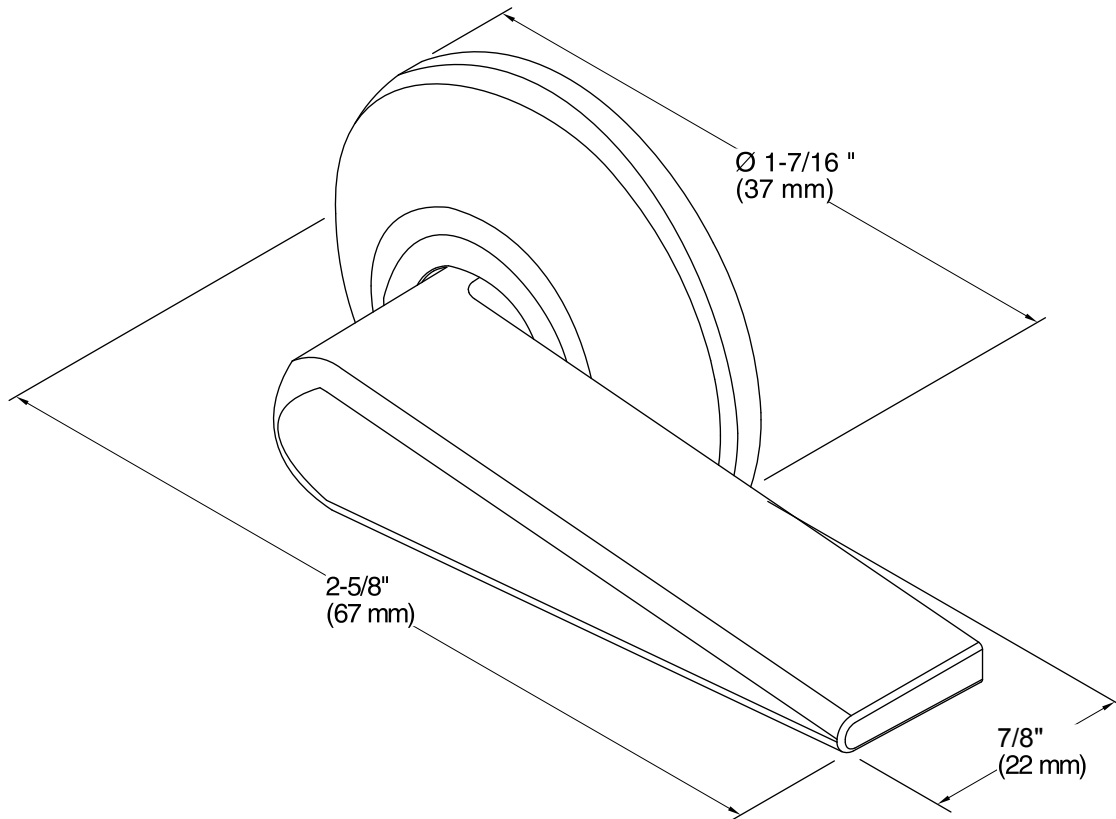

Technical Information

All product dimensions are nominal.

Notes

ADA compliant when installed to the specific requirements of these regulations.