

Features

- 33-inch minimum base cabinet width.
- Double equal bowl.
- 1 faucet hole (-1).
- 9 inch depth.
- Includes cutout templates.

Material

- KOHLER enameled cast iron.

Installation

- Top-mount.

Recommended Accessories

- K- 9000 P-Trap
- K- 8801 Sink Strainer

Components

Product includes:

- K- 6239 Colander with Cutting Board
- K- 9238 Stainless Steel Sink Rack



Codes/Standards











ASME A112.19.1/CSA B45.2

KOHLER® Enameled Cast Iron Kitchen Sink - Lifetime Limited Warranty

See website for detailed warranty information.

Available Color/Finishes

Color tiles intended for reference only.

| Color | Code | Description |
|--|------|--------------|
|  | 0 | White |
|  | FF | Sea Salt™ |
|  | 96 | Biscuit |
|  | 47 | Almond |
|  | FD | Cane Sugar™ |
|  | 95 | Ice™ Grey |
|  | G9 | Sandbar |
|  | K4 | Cashmere |
|  | 20 | Suede |
|  | KA | Black 'n Tan |
|  | 7 | Black Black™ |

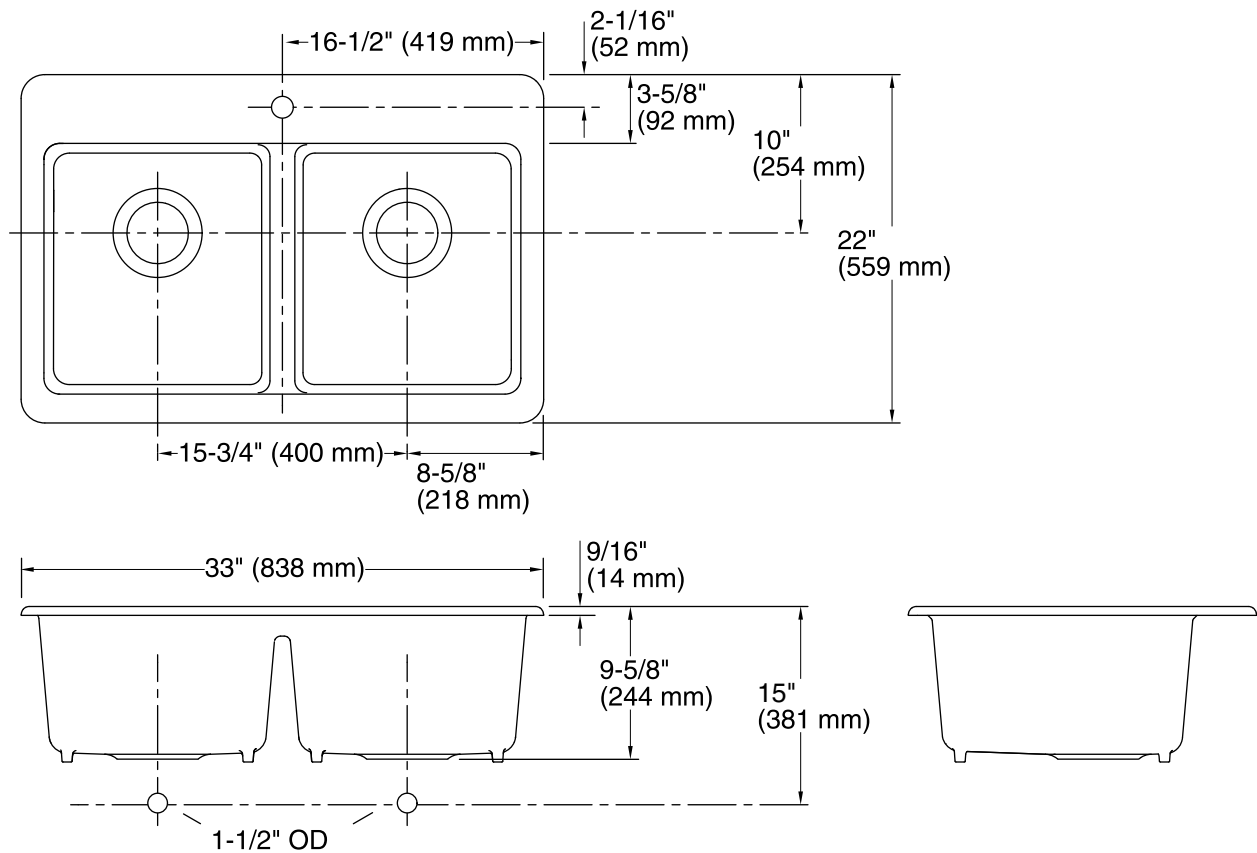

Technical Information

All product dimensions are nominal.

Bowl configuration: Double equal

Installation: Top-mount

Min. base cabinet width: 33" (838 mm)

Bowl area (Left) Length: 14-5/16" (363 mm)

Width: 17-1/4" (438 mm)

Bowl depth: 9" (229 mm)

Water depth: 9" (229 mm)

Bowl area (Right) Length: 14-5/16" (363 mm)

Width: 17-1/4" (438 mm)

Bowl depth: 9" (229 mm)

Water depth: 9" (229 mm)

Drain hole: 3-7/8" (98 mm)

Template: Top-mount, 1166727-7, required, included

Notes

Install this product according to the installation guide.