

Features

- 33-inch minimum base cabinet width.
- Offset double bowl.
- 1 faucet hole (-1).
- 9 inch depth.
- Includes cutout templates.

Material

- KOHLER enameled cast iron.

Installation

- Top-mount.

Recommended Accessories

K- 9000 P-Trap

Optional Accessories

K- 8801 Sink Strainer

Components

Product includes:

K- 9234 Stainless Steel Sink Rack

K- 6239 Colander with Cutting Board



Codes/Standards











ASME A112.19.1/CSA B45.2

KOHLER® Enameled Cast Iron Kitchen Sink - Lifetime Limited Warranty

See website for detailed warranty information.

Available Color/Finishes

Color tiles intended for reference only.

Color	Code	Description
	0	White
	FF	Sea Salt™
	96	Biscuit
	47	Almond
	FD	Cane Sugar™
	95	Ice™ Grey
	G9	Sandbar
	K4	Cashmere
	20	Suede
	KA	Black 'n Tan
	7	Black Black™

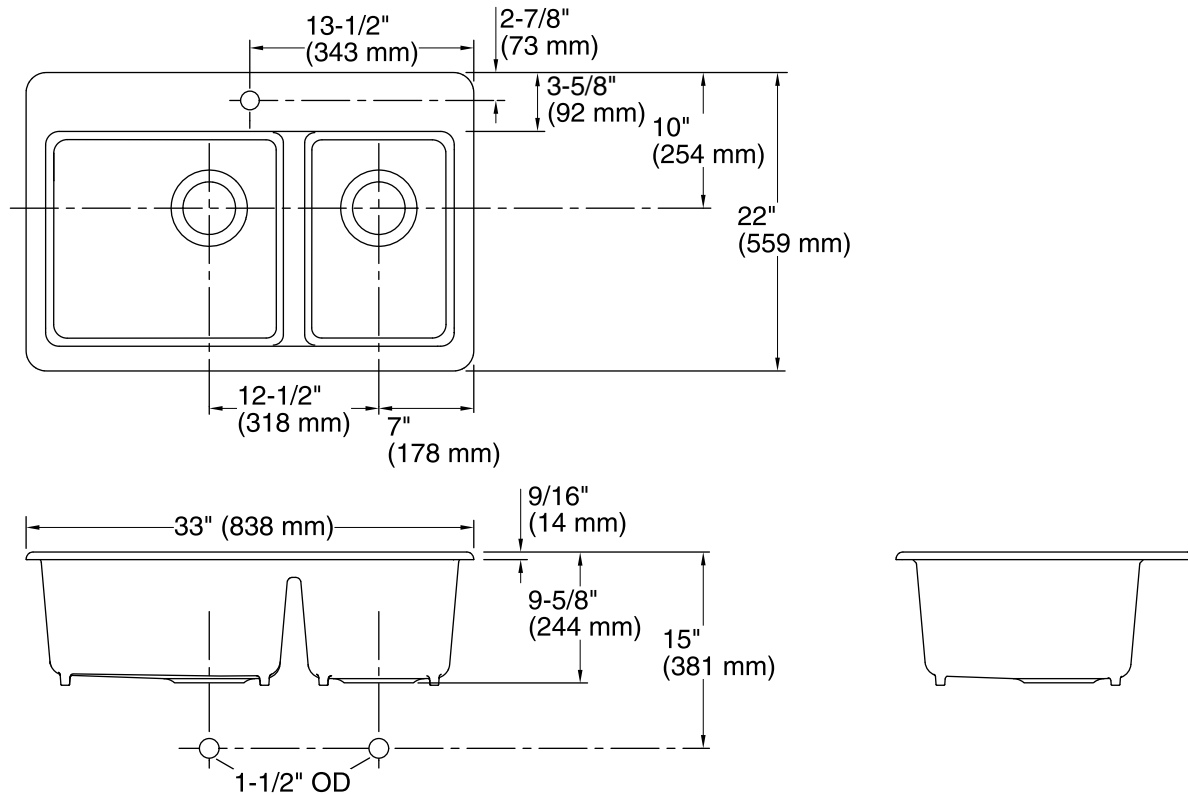

Technical Information

All product dimensions are nominal.

Bowl configuration: Offset

Installation: Top-mount

Min. base cabinet width: 36" (914 mm)

Bowl area (Left) Length: 17-9/16" (446 mm)
 Width: 17-1/4" (438 mm)
 Bowl depth: 9" (229 mm)
 Water depth: 9" (229 mm)

Bowl area (Right) Length: 11-1/16" (281 mm)
 Width: 17-1/4" (438 mm)
 Bowl depth: 9" (229 mm)
 Water depth: 9" (229 mm)

Number of deck holes: 1

Faucet hole(s): 1-3/8" (35 mm)

Drain hole: 3-7/8" (98 mm)

Template: Top-mount, 1166727-7, required, included

Notes

Install this product according to the installation guide.