

Application

Designed for installation on potable water lines to protect against both backsiphonage and backpressure of contaminated water into the potable water supply. Assembly shall provide protection where a potential health hazard exists. The Model 475 is for applications requiring vertical flow up and vertical flow down. The Model 475V is for applications requiring vertical flow up. Ideal for use where lead-free* valves are required.

Standards Compliance

- ASSE® Listed 1013
- AWWA Compliant C511, and C550
- CSA® Certified
- IAPMO® Listed
- UL® Classified
- C-UL® Classified
- FM® Approved
- NYC MEA 468-99-M VOL 4
- Approved by the Foundation for Cross Connection Control and Hydraulic Research at the University of Southern California
- NSF® Listed-Standard 61, Annex G*

*(0.25% MAX. WEIGHTED AVERAGE LEAD CONTENT)

Materials

Main valve body	Ductile Iron ASTM A 536 Grade 4
Access covers	Ductile Iron ASTM A 536 Grade 4
Coatings	FDA Approved fusion epoxy finish
Internals	Stainless steel, 300 Series NORYL™, NSF Listed
Fasteners	Stainless Steel, 300 Series
Elastomers	EPDM (FDA approved) Buna Nitrile (FDA approved)
Polymers	NORYL™, NSF Listed
Springs	Stainless steel, 300 series
Sensing line	Stainless steel, braided hose

Features

Sizes:	2 1/2", 3"	
Maximum working water pressure		175 PSI
Maximum working water temperature		140°F
Hydrostatic test pressure		350 PSI
End connections	(Grooved for steel pipe) (Flanged)	AWWA C606-87 ANSI B16.1 Class 125

Dimensions & Weights (do not include pkg.)

Model 475 Size	WEIGHT												
	Less Shut-off Valves		With NRS Gate Valves Flanged		With NRS Gate Valves Grooved		With OSY Gate Valves Flanged		With OSY Gate Valves Grooved		With Butterfly Valves Grooved		
	in.	mm	lbs.	kg	lbs.	kg	lbs.	kg	lbs.	kg	lbs.	kg	
2 1/2	65	87	39	196	89	178	81	205	93	187	85	149	68
3	80	112	51	234	106	204	93	240	109	192	87	185	84

Model 475 Size	DIMENSIONS (approximate)																																																	
	A		B Gate Valves		B Butterfly Valves		B Less Shut-off Valves		C OS&Y Open		C OS&Y Closed		C NRS Gates		C Butterfly Valves		D		E Gate Valves		E Butterfly Valves		E Less Shut-off Valves		F Gate Valves		F Butterfly Valves		F Less Shut-off Valves		G Gate Valves		G Butterfly Valves																	
	in.	mm	in.	mm	in.	mm	in.	mm	in.	mm	in.	mm	in.	mm	in.	mm	in.	mm	in.	mm	in.	mm	in.	mm	in.	mm	in.	mm	in.	mm	in.	mm	in.	mm																
2 1/2	65	26	660	20	1/2	521	19	483	13	330	17	3/4	451	15	3/8	391	11	1/2	292	8	1/4	210	3	3/4	95	26	1/8	664	23	1/8	587	11	1/8	283	12	9/16	319	11	1/16	281	5	1/16	129	4	1/8	105	2	5/8	67	
3	80	27	686	21	1/2	546	19	3/4	502	13	1/2	343	20	1/4	514	17	4/32	12	3/4	324	8	1/2	216	3	3/4	95	27	1/8	689	24	1/8	613	11	1/8	283	13	9/16	344	11	13/16	300	5	9/16	141	4	9/16	116	2	13/16	71



Certified to NSF/ANSI 61-G

Options

(Suffixes can be combined)

- with NRS shut-off valves (standard)
- FSC - with epoxy coated wye type strainer (flanged only)
- G - with groove end connections
- FG - with flanged inlet connection and grooved outlet connection
- L - less shut-off valves (flanged body connections)
- OSY - with OS & Y gate valves
- MS - with Integral Relief Valve Monitor Switch
- V - vertical flow up configuration
- BG - with grooved end butterfly valves with integral supervisory switches

Accessories

- Repair kit (rubber only)
- Thermal expansion tank (Model XT)
- Valve setter (Model FLS or MJS or MJFS)
- Gate valve tamper switch (OSY-40)
- Air gap (Use Model AG-6)
- QT-SET Quick Test Fitting Set
- Electronic Solenoid Timer (Model EST)

Relief Valve discharge port:
2 1/2" - 6" - 2.75 sq. in.

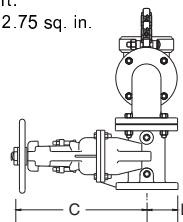

Model 475

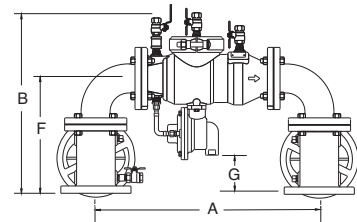

Model 475V

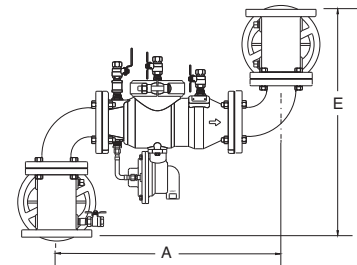
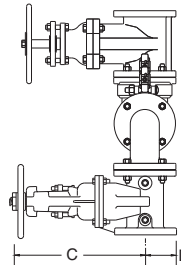

MODEL 475 & 475V 2 1/2" & 3" (STANDARD & METRIC)

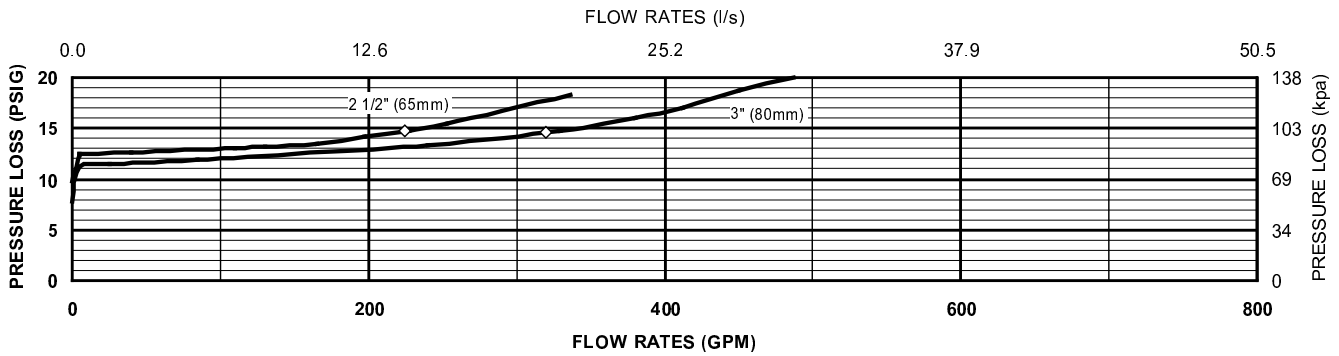

Typical Installation

Local codes shall govern installation requirements. To be installed in accordance with the manufacturers' instructions and the latest edition of the Uniform Plumbing Code. Unless otherwise specified, the assembly shall be mounted at a minimum of 12" (305mm) and a maximum of 30" (762mm) above adequate drains with sufficient side clearance for testing and maintenance. The installation shall be made so that no part of the unit can be submerged.

Capacity thru Schedule 40 Pipe (GPM)				
Pipe size	5 ft/sec	7.5 ft/sec	10 ft/sec	15 ft/sec
2 1/2"	75	112	149	224
3"	115	173	230	346
4"	198	298	397	595
6"	450	675	900	1351
8"	780	1169	1559	2339
10"	1229	1843	2458	3687

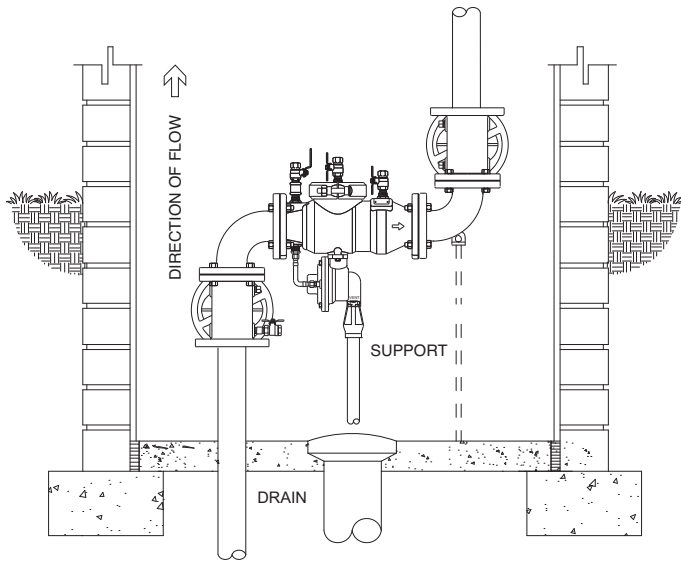

INDOOR INSTALLATION

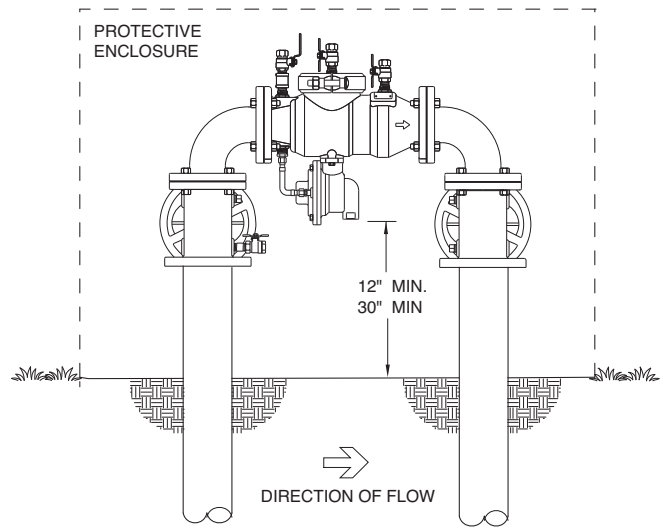

OUTDOOR INSTALLATION

Specifications

The Reduced Pressure Principle Backflow Preventer shall be ASSE® Listed 1013, and supplied with full port gate valves. The main body and access covers shall be epoxy coated ductile iron (ASTM A 536 Grade 4), the seat ring and check valve shall be NORYL™, the stem shall be stainless steel (ASTM A 276) and the seat disc elastomers shall be EPDM. Center stem guided design shall incorporate two torsion springs to bias the check in the closed position. The first and second checks shall be accessible for maintenance without removing the relief valve or the entire device from the line. If installed indoors, the installation shall be supplied with an air gap adapter. The Reduced Pressure Principle Backflow Preventer shall be a ZURN WILKINS Model 475 or 475V.