

Iron-A-Way

Managing space with style



Installation Manual

MODELS:

AE46, AE42, E46, E42, ANE46, ANE42, NE46, NE42



TABLE OF CONTENTS

SWIVEL UNITS (AE46, AE42, ANE46, ANE42).....pg.3

NON-SWIVEL UNITS (E46, E42, NE46, NE42).....pg.11

ELECTRICAL INSTRUCTIONS.....pg.17

**Premier Storage Systems
220 W. Jackson St, Morton, IL 61550
1-800-536-9495 or info@ironaway.com**

Swivel Units

Models: AE46, AE42, ANE46, ANE42

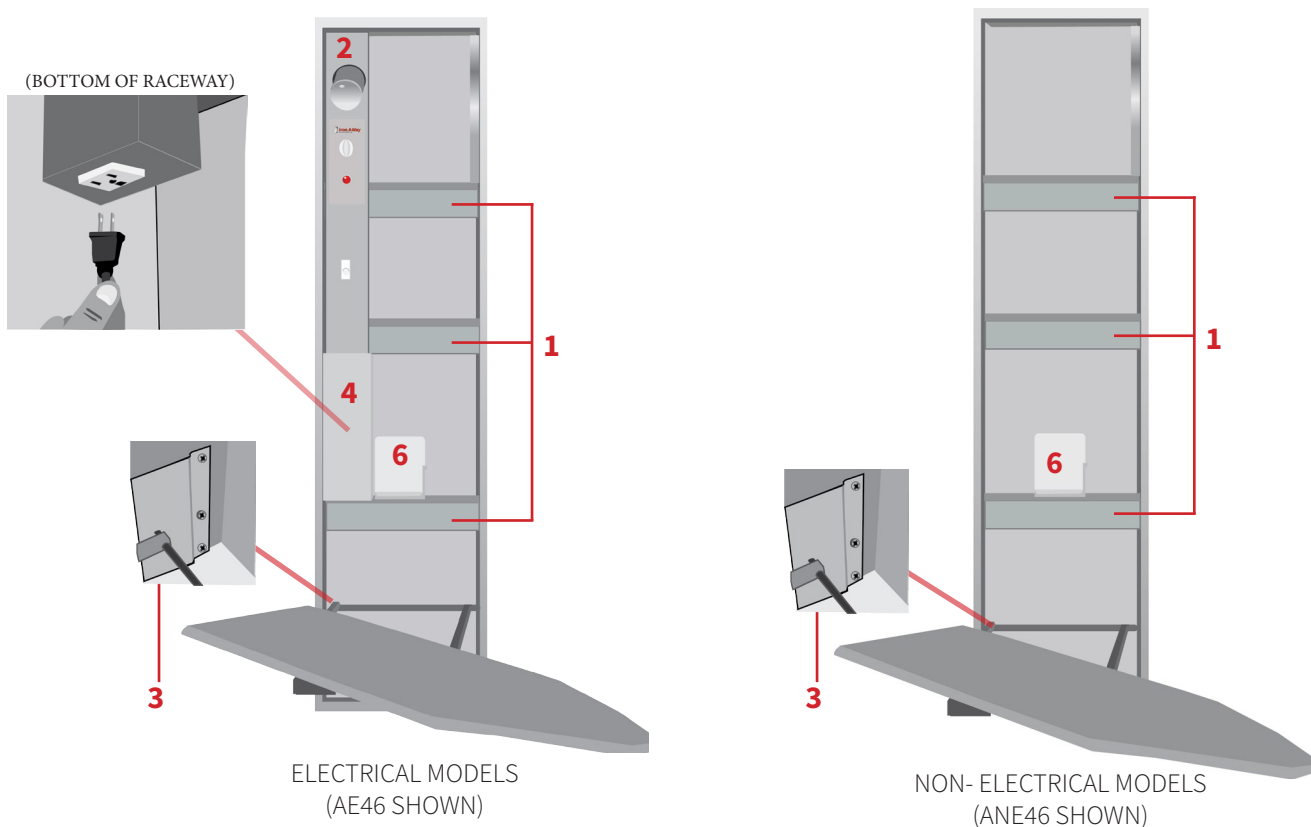

GET TO KNOW YOUR UNIT

1. CROSS BRACES

- Three braces for 46" units
- Two braces for 42" units

2. ELECTRICAL RACEWAY (AE46, AE42)

3. SIDE BRACKETS

4. ELECTRICAL CORD COVER (AE46 only; AE42 features a cord wrap)

5. ELECTRICAL OUTLET

6. HOT IRON REST (AE46, ANE46)

Tools Needed:

- Stud Finder
- 1/4" Nut Driver (optional)
- 12-14" Level
- Safety Glasses
- Tape Measure
- Utility Knife
- Small Flathead Screwdriver
- Electric Drill (with 1/4" & 1/8" drill bit)

Supplied Parts:

Recessed Mounting:

- Two #10 x 1 1/2" wood screws for top portion of cabinet
- Two #14 x 2 1/2" Phillips screws for top side brackets

Surface Mounting:

- Two #14 x 4" wood screws

SWIVEL: PRE-INSTALLATION

1. DETERMINE MOUNTING HEIGHT

Using the charts provided, determine the mounting height above floor (the distance between the floor and the bottom of the cabinet). First choose your desired ironing board height from the left column, then locate the corresponding mounting height in the right column.

AE46 & ANE46

Desired Ironing Board Height	Mounting Height Above Floor
36"	29"
35"	28"
34"	27"
33"	26"

AE42 & ANE42

Desired Ironing Board Height	Mounting Height Above Floor
36"	25"
35"	24"
34"	23"
33"	22"

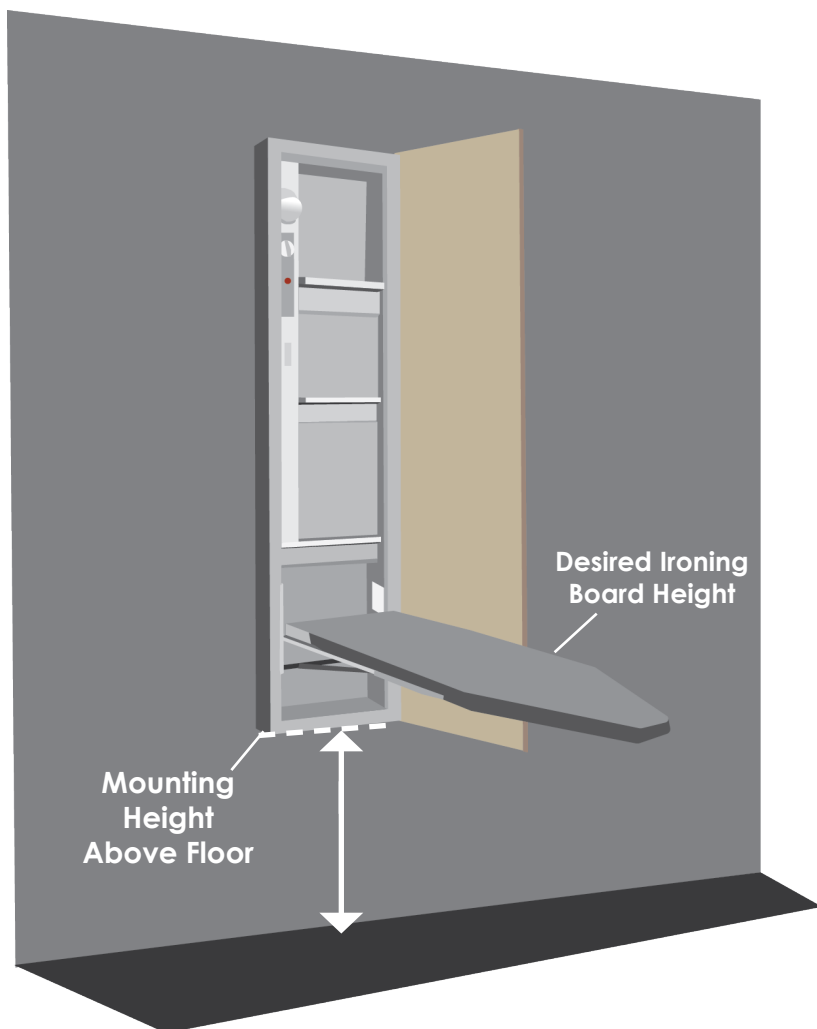

2. LOCATE STUDS & UTILITIES

Using a stud finder, locate the wall studs to be used for mounting.

Locate the existing wiring or other utilities in the wall to prevent drilling into/severing a wire and/or other utility during installation.

3. ENSURE ADEQUATE SPACE

Refer to the chart provided below to ensure adequate clearance for ironing. The cabinet door opens at 180 degrees; allow 16" from side of cabinet for door to fully open.

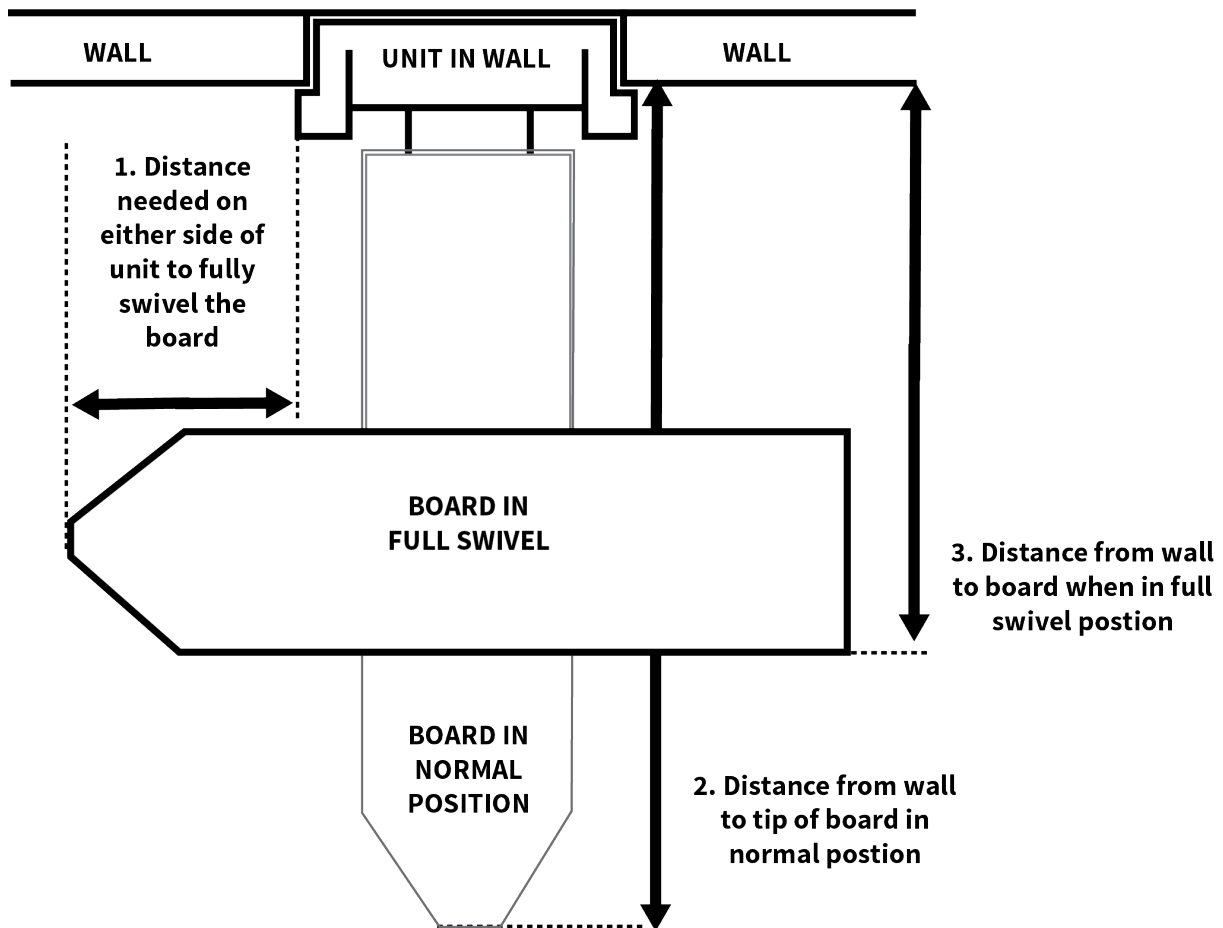

	AE46 ANE46	AE42 ANE42
1. Distance needed on either side of unit to fully swivel the board	16⁷/₈"	14⁵/₈"
2. Distance from wall to tip of ironing board	50⁷/₈"	46⁷/₈"
3. Distance from wall to board when in full swivel position	32⁷/₈"	32⁷/₈"
4. Standing area clearance (not shown) <i>The suggested distance from the side of the ironing where the user typically stands to ensure adequate space for ironing.</i>	24"	24"

SWIVEL: RECESSED INSTALLATION

Note: Instructions based on installation between 16" on-center studs.

1. CUT WALL OPENING

Cut an opening into the wall based on unit dimensions given below.

AE46/ANE46: 14^{3/8"} x 59^{7/8"} x 3^{7/8"}

AE42/ANE42: 14^{3/8"} x 51^{1/4"} x 3^{7/8"}

2. ATTACH CLEATS

Attach a 2" x 4" cross support cleat between the studs so it is level with the bottom of the opening. This will give support to the drywall during installation and the cabinet once installed in the wall.

3. PRE-DRILL HOLES

Your unit will be attached to the studs by screws in the upper and lower sides of the cabinet.

AE46 & AE42: Remove electrical raceway before proceeding by removing the top and bottom screws on the raceway.

Using a 1/8" drill bit, pre-drill holes into the sides of the cabinet, 14" from the top and 2 1/2" from the back.

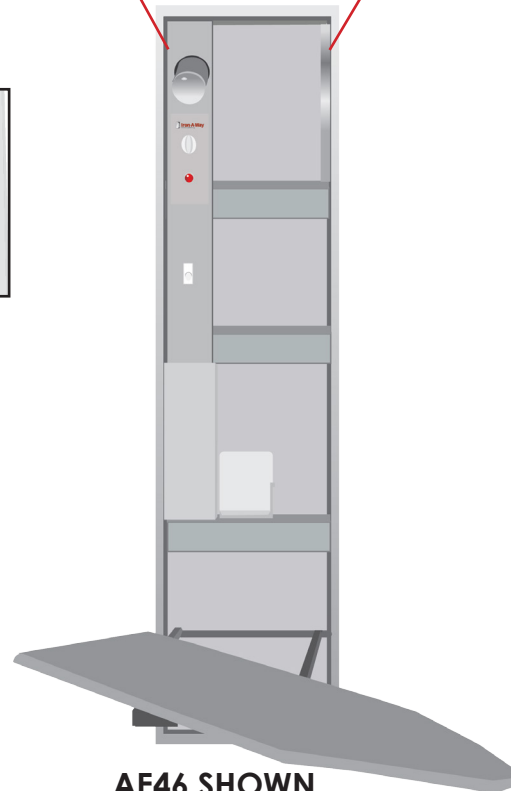
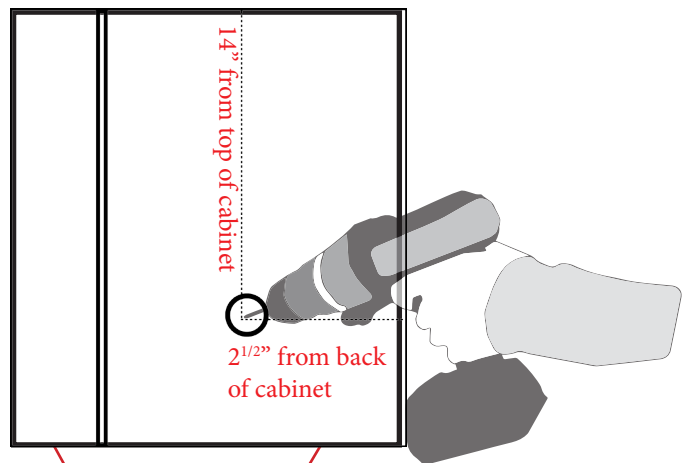
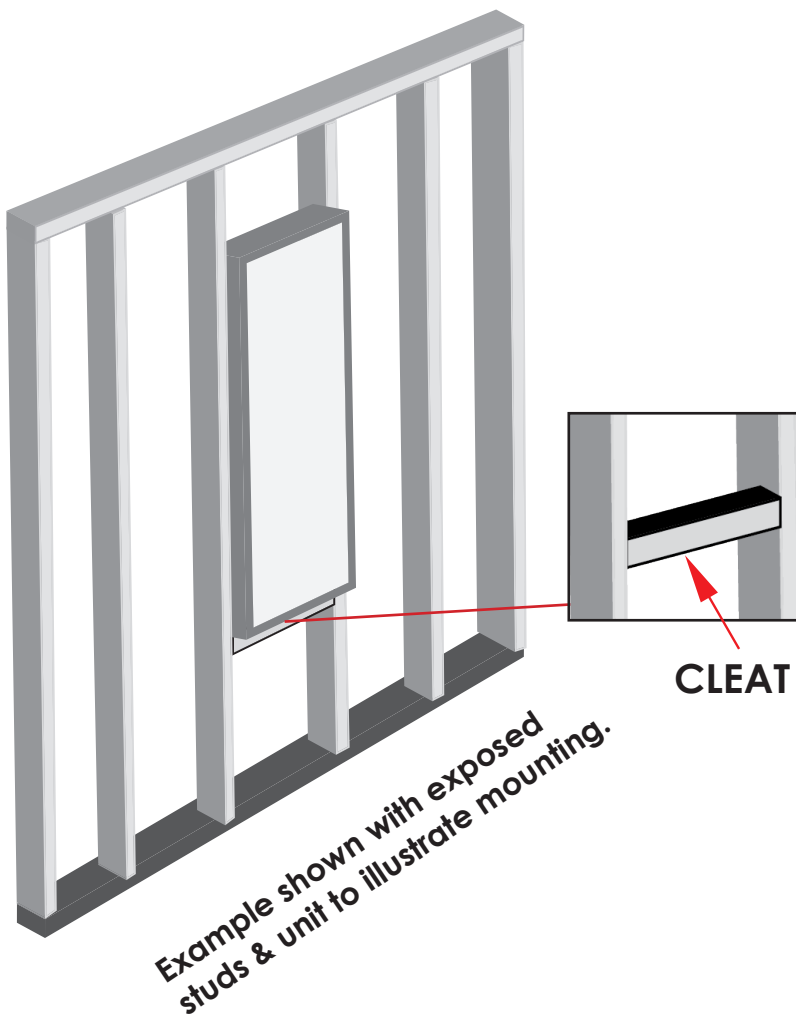

MODELS AE46 & AE42:

Refer to electrical instructions on pg.17 before proceeding to next step.

MODELS ANE46 & ANE42:

Proceed to next step.

DO NOT attempt to install your own electrical to unit. Warranty is voided if independent electrical is installed.

4. INSTALL UNIT IN WALL

Begin installation by carefully lifting unit into the wall opening. Make sure the cabinet is plumb and level. If needed, add shims to help unit fit snug in place.

5. ATTACH CABINET TO STUDS

Using the pre-drilled holes in top of cabinet, attach unit to studs with two #10 x 1^{1/2}" screws for top installation.



Example shown with studs to illustrate mounting.

6. REMOVE BRACKET SCREW

Locate side ironing board brackets that are secured to cabinet with three screws. **Then remove the top screw from each bracket.** This is where the bottom part of your cabinet will be secured to the studs.

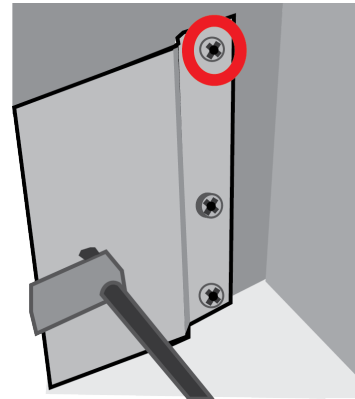

7. PRE-DRILL HOLES IN SIDES

Pre-drill holes into the cabinet using the holes in side brackets where screws were just removed.

Finish installation by screwing the two #14 x 2^{1/2}" screws into the pre-drilled holes to secure bottom part of cabinet into the cabinet.

FOR MODELS AE46 & AE42:

Please refer back to electrical instructions to complete the electrical part of your installation.

8. INSTALLATION COMPLETE!

Cabinet is now fully installed! If desired, decorative trim or molding may be added to cover any irregularities in the wall.

SWIVEL: SURFACE MOUNT INSTALLATION

1. PREPARE CABINET

Screws will be drilled through the upper and lower cross braces (see illustration on pg.3) inside the cabinet. Determine location of screws, ensuring that the location of the mounting screw is as close to the center of the cabinet as possible.

2. PRE-DRILL PILOT HOLES

Using a 1/4" drill bit, pre-drill holes in the upper and lower cross braces inside the cabinet as determined in previous step. Ensure that the holes in both braces are drilled to the same measurement.

3. LOCATE & MARK STUD

Using a stud finder, locate stud in wall and mark the wall according to the pre-drilled holes in cabinet. Setting cabinet aside, pre-drill holes in wall using a 1/4" drill bit. **Do not attempt to mount only through hard board of cabinet.**



4. PARTIALLY INSERT SCREW

Partially insert a #14 x 4" screw in the upper cross brace.

MODELS AE46 & AE42:

Refer to electrical instructions on pg. 17 before proceeding to next step.

MODELS ANE46 & ANE42:

Proceed to next step.

DO NOT attempt to install your own electrical to unit. Warranty is voided if independent electrical is installed.

5. INSTALL UNIT

Begin installation by carefully lifting unit into position. Then, attach the cabinet to the wall by fully inserting the screw in the upper cross brace into the wall stud.

Make sure the unit is plumb and level. Shim if necessary. **Fully tighten installation screw.**

6. INSERT SECOND SCREW

Insert the second #14 x 4" screw into the pre-drilled hole in the bottom brace of the cabinet and attach to wall making sure cabinet remains square and level.

FOR MODELS AE46 & AE42:

Please refer back to electrical instructions to complete the electrical part of your installation.

7. ADD TRIM

Add Decorative trim or molding to make cabinet sides flush with the face frame.

8. REMOVE BRACKET SCREW

Locate side ironing board brackets that are secured to cabinet with three screws. **Then remove the top screw from each bracket.** Replace with a #14 x 3/4" Phillips screw. This will add stability long-term.

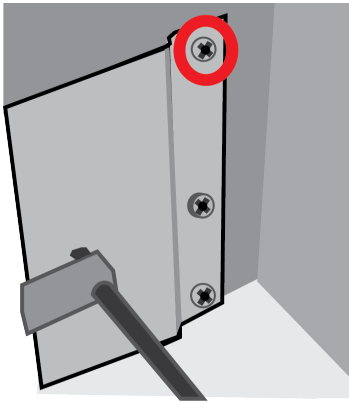

9. INSTALLATION COMPLETE

Cabinet is now fully installed!

THIS PAGE INTENTIONALLY LEFT BLANK

Non-Swivel Units

Models: E46, E42, NE46, NE42

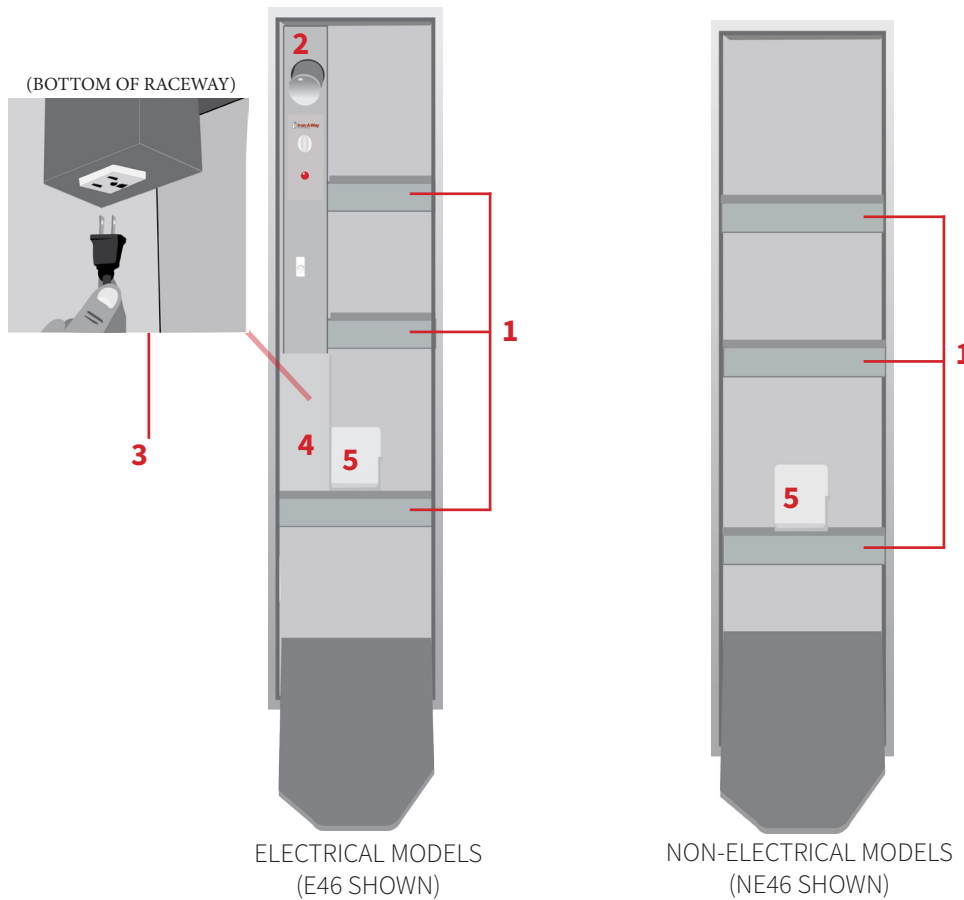

GET TO KNOW YOUR UNIT

1. CROSS BRACES

- Three braces for 46" units
- Two braces for 42" units

2. ELECTRICAL RACEWAY

(E46, E42)

3. ELECTRICAL OUTLET

4. ELECTRICAL CORD COVER

(E46 only; E42 features a cord wrap)

5. HOT IRON REST

(E46, NE46)

Tools Needed:

- Stud Finder
- 1/4" Nut Driver (optional)
- 12-14" Level
- Safety Glasses
- Tape Measure
- Utility Knife
- Small Flathead Screwdriver
- Electric Drill (with 1/4" & 1/8" drill bit)

Supplied Parts:

Recessed Mounting:

- Four #10 x 1¹/₂" wood screws for top portion of cabinet
- Two #14 x 2¹/₂" Phillips screws for top side brackets

Surface Mounting:

- Two #14 x 4" wood screws

NON-SWIVEL: PRE-INSTALLATION

1. DETERMINE MOUNTING HEIGHT

Using the charts provided at right, determine the mounting height above floor (the distance between the floor and the bottom of the cabinet) for your unit. First choose your desired ironing board height from the left column, then locate the corresponding mounting height in the right column.

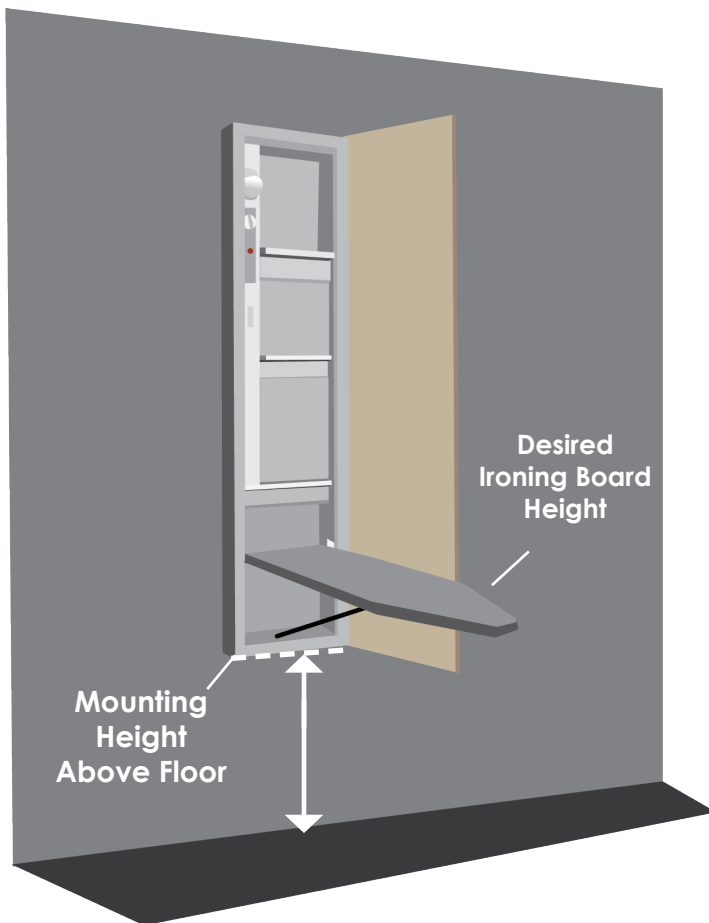

E46 & NE46

Desired Ironing Board Height	Mounting Height Above Floor
36"	29"
35"	28"
34"	27"
33"	26"

E42 & NE42

Desired Ironing Board Height	Mounting Height Above Floor
36"	25"
35"	24"
34"	23"
33"	22"

2. LOCATE STUDS & UTILITIES

Using a stud finder, locate the wall studs to be used for mounting.

Locate the existing wiring or other utilities in the wall to prevent drilling into/severing a wire and/or other utility during installation.

3. ENSURE ADEQUATE SPACE

Refer to provided chart to ensure adequate clearance for ironing. The cabinet door opens at 180 degrees; allow 16" from side of cabinet for door to fully open.

	E46 NE46	E42 NE42
Distance from wall to tip of ironing board	46 ^{1/4} "	42"
Standing area clearance (not shown) <i>The suggested distance from the side of the ironing where the user typically stands to ensure adequate space for ironing.</i>	24"	24"

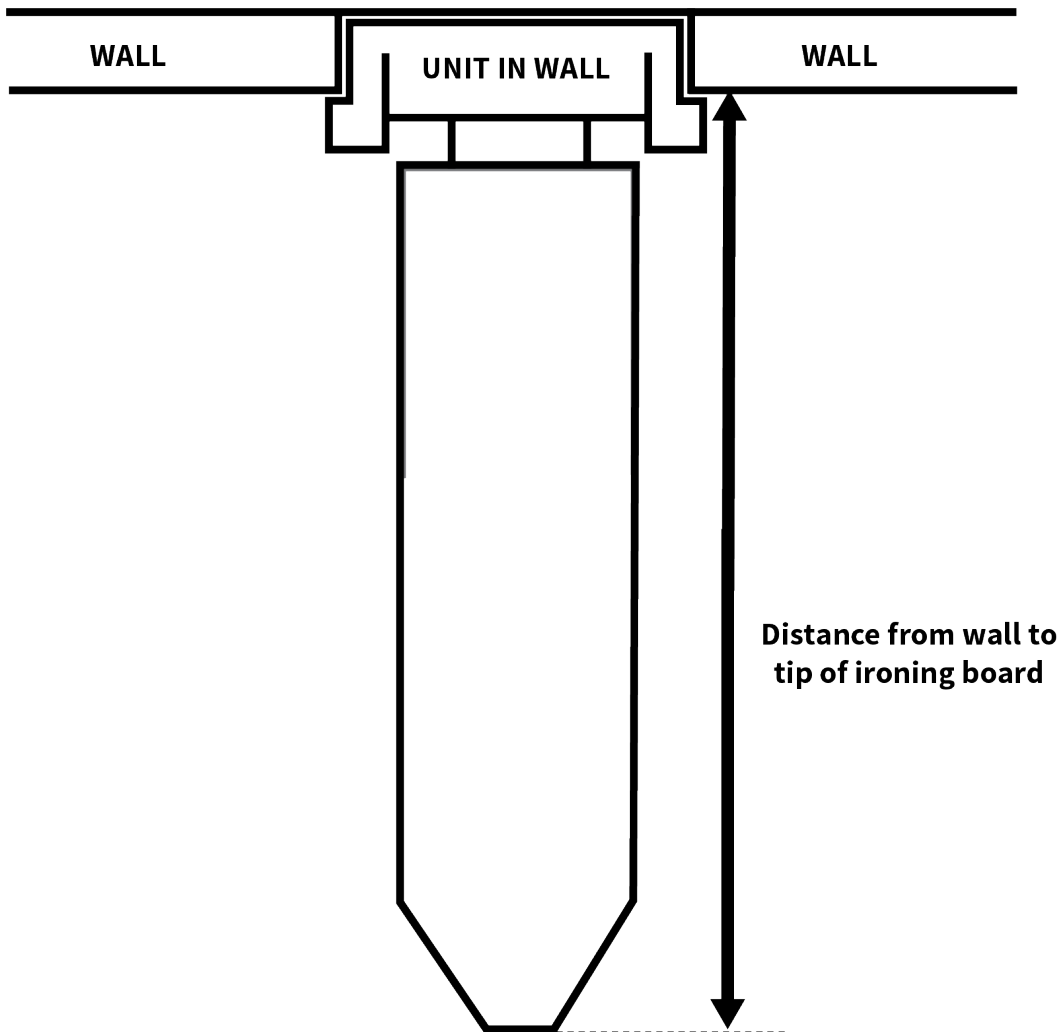

NON-SWIVEL: RECESSED INSTALLATION

Note: Instructions based on installation between 16" on-center studs.

1. CUT WALL OPENING

Cut an opening into wall using the unit dimensions below:

E46/NE46: 14^{3/8"} x 59^{7/8"} x 3^{7/8"}

E42/NE42: 14^{3/8"} x 51^{1/4"} x 3^{7/8"}

2. ATTACH CLEATS

Attach a 2" x 4" cross support cleat between the studs, level with the bottom of the opening. This will give support to the dry wall during installation and to the cabinet once installed in the wall.

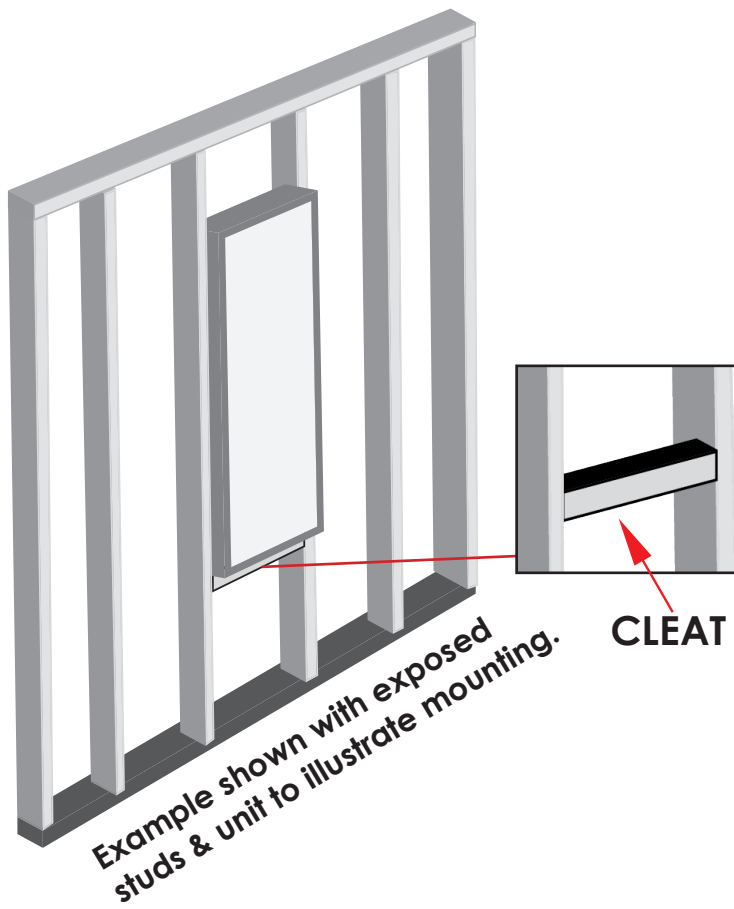

3. PRE-DRILL HOLES

Your unit will be attached to the studs by screws in the upper and lower sides of the cabinet.

E46, E42: Remove electrical raceway before proceeding by removing the top and bottom screws on the raceway.

To prepare the cabinet, **pre-drill holes with 1/8" bit into the sides of the top of the cabinet, 14" from the top and 2 1/2" from the back.** Then pre-drill holes in the sides of the bottom of the cabinet, 14" from bottom, 2 1/2" from back.

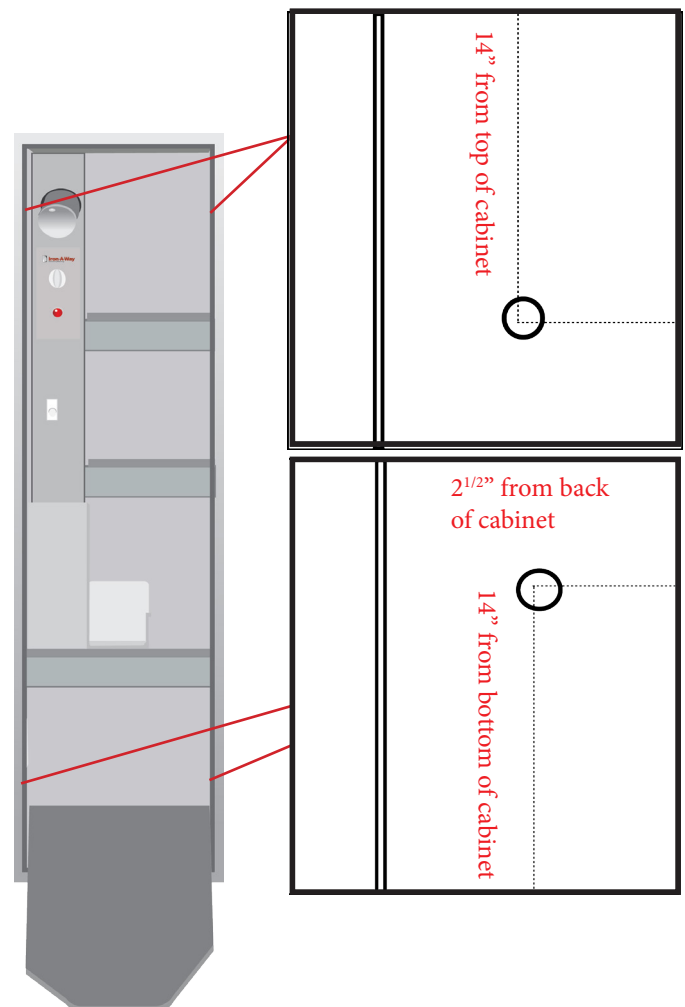

MODELS E46 & E42:

Refer to electrical instructions on pg. 17 before proceeding to next step.

MODELS NE46 & NE42:

Proceed to next step.

DO NOT attempt to install your own electrical to unit. Warranty is voided if independent electrical is installed.



Example shown with studs to illustrate mounting.

4. INSTALL UNIT INTO WALL

Begin installation by carefully lifting unit into the wall opening.

Make sure the cabinet is plumb and level. If needed, add shims to help unit fit space.

5. ATTACH CABINET TO STUDS

Using the pre-drilled holes in top of cabinet, attach unit to studs with two #10 x 1^{1/2}" screws for top installation.

6. FINISH INSTALLATION

Finish installation by inserting the #14 x 2^{1/2}" screws in bottom pre-drilled holes.

FOR MODELS E46 & E42:

Please refer back to electrical instructions to complete the electrical part of your installation.

7. INSTALLATION COMPLETE!

Cabinet is now fully installed! If desired, decorative trim or molding may be added to cover any irregularities in the wall.

Non-Swivel: Surface Mount Installation

1. PREPARE CABINET

Screws will be drilled through the upper and lower cross braces (see pg. 11) inside the cabinet. Determine location of screws, ensuring that the location of the mounting screw is as close to the center of the cabinet as possible.

2. PRE-DRILL HOLES

Using a 1/4" drill bit, pre-drill holes in the upper and lower cross braces inside the cabinet as determined in previous step. Ensure that the holes in both braces are drilled to the same measurement.

3. LOCATE & MARK STUD

Using a stud finder, locate desired stud in wall and mark the wall according to the pre-drilled holes in cabinet. Setting cabinet aside, pre-drill holes in stud using a 1/4" drill bit. **Do not attempt to mount only through hardboard of cabinet.**



4. PARTIALLY INSERT SCREW

Partially insert one #14 x 4" screw in the upper cross brace.

MODELS E46 & E42:

Refer to electrical instructions on pg.17 before proceeding to next step.

MODELS NE46 & NE42:

*Proceed to next step. **DO NOT** attempt to install your own electrical to unit. Warranty is voided if independent electrical is installed.*

5. INSTALL UNIT

Begin installation by carefully lifting unit into position. Then attach the cabinet to the wall by fully inserting the screw in the upper cross brace into the wall stud.

Make sure the unit is plumb and level. Shim if necessary. **Fully tighten installation screw.**

6. INSERT SECOND SCREW

Insert the second #14 x 4" screw into the pre-drilled hole in the bottom brace of the cabinet and attach to wall making sure cabinet remains square and level.

FOR MODELS E46 & E42:

Please refer back to electrical instructions to complete the electrical part of your installation.

7. ADD TRIM

Add decorative trim or molding to make cabinet sides flush with the face frame.

8. INSTALLATION COMPLETE

Cabinet is now fully installed!

Electrical Instructions

Models: AE46, AE42, E46, E42



ATTENTION!

DISCONNECT ALL POWER BEFORE BEGINNING ELECTRICAL INSTALLATION.

ALL ELECTRICAL MUST COMPLY WITH LOCAL AND NATIONAL CODES.

IF YOU ARE UNFAMILIAR WITH ELECTRICAL WIRING, PLEASE CONTACT A QUALIFIED ELECTRICIAN TO COMPLETE THIS PORTION OF INSTALLATION.

WARNING:

The following electrical instructions are for models AE46, AE42, E46, E42 ONLY.

DO NOT attempt to install independent or separate outlet and/or switches inside the ANE46, NE46, ANE42, NE42. Doing so will create an electrical hazard and void the warranty of the unit.

Ensure that power is disconnected at service entrance before proceeding.

1. REMOVE ELECTRICAL KNOCKOUT

Open the front cover of the raceway by removing the screw at the top and bottom of the raceway.

Locate the electrical knockout, as specified on diagrams provided.

Install a 3/8" romex connector where the knockout was removed.

Position of Electrical Knockout for RECESSED UNIT



2. INSTALL ELECTRICAL WIRING

Verify that there is ample supply wire available to run from the top of the ironing center to the approximate location of electrical pigtails.

Note: A free wire length of 48" is recommended.

Begin to place the ironing center into its location while feeding the supply wire through electrical knockout, and the 3/8" romex connector through the back of the raceway.

Position of Electrical Knockout for SURFACE MOUNT ONLY

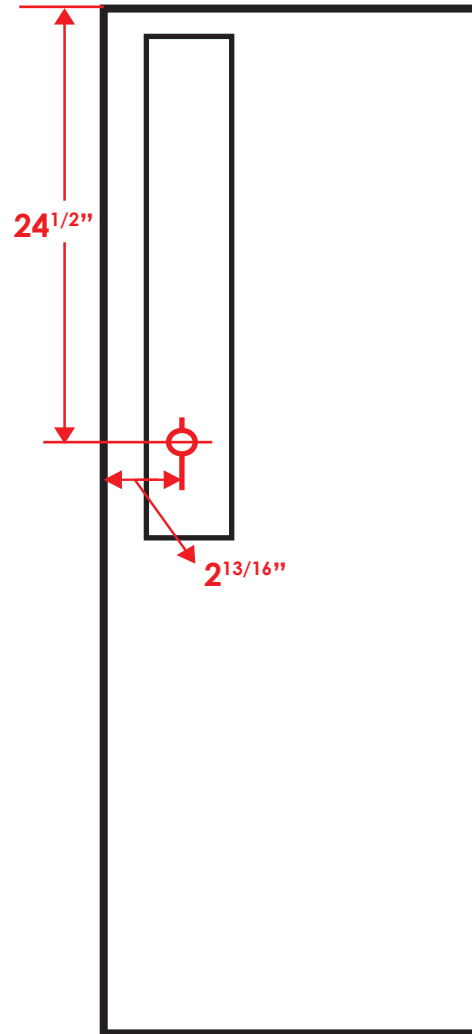

Refer back to installation instructions before completing steps on next page.

3. CONNECT WIRES

Connect all power supply wires and ground wires in accordance with electrical codes. Trim supply wire as necessary.

4. REPLACE ELECTRICAL RACEWAY

Place the raceway cover into position, ensuring that no wires are pinched. Reinstall the top and bottom screw to secure in place.

Reconnect power supply and return to installation instructions.



220 W. Jackson St, Morton, IL 61550
1-800-536-9495 or info@ironaway.com

001072 05/17