

## Ac-U-Temp HOT WATER SUPPLY SYSTEMS

The "TOTAL SYSTEM" Concept - We have taken our highly efficient equipment and created a convenient package; a complete domestic hot water system.

### FEATURES

#### SIMPLIFIES INSTALLATION

- The installer simply connects the flue, gas, electric supply, cold water make-up, and hot water supply (Building return loops connect to cold water make-up.)

#### ELIMINATES COSTLY FIELD ERRORS

- These complete hot water systems are factory-engineered and assembled to assure proper pipe, pump and wiring sizing
- Systems are pre-piped and wired to guarantee maximum system efficiency

#### FACTORY TESTED

- Each Ac-U-Temp system is hydrostatic and fire tested before shipping from the factory

#### AC-U-TEMP STORAGE TANKS

- Each Ac-U-Temp storage tank is especially designed with tank opening locations that provide maximum tank draw efficiency and eliminate any unnecessary piping and connections
- Standard Ac-U-Temp tanks are factory jacketed and insulated (Bare tanks to be insulated by others are also available.)
- The Ac-U-Tanks are factory standard with the same superior glass lining that has set new standards for the tank industry
- Standard tank capacities range from 80 gallons to 1,000 gallons (Custom tanks to 10,000 gallons are available)

#### OTHER FEATURES

##### ASME TEMPERATURES AND PRESSURE RELIEF VALVE 125#

- Tank Temperature Sensor
- Tank Thermometer
- Isolation Valves (Reliable Ball Valves)
- Superior I-Beam Skid
- 125 psi Tank Construction
- Factory sized and supplied pump

#### OPTIONS

- Sequencing Control Panel (For Multi-Unit systems)
- 150 and 160 psi Tank Construction
- 11" x 15" Manholes
- Cement and Epoxy Tanks Linings

#### CUSTOM AC-U-TEMP SYSTEMS

- All Ac-U-Temp Systems are built-to-order, and can be precisely designed to specifically meet your specifications
- Many combinations of heaters and tanks are available. Consult your local A. O. Smith Representative for factory assistance.

#### MULTI-UNIT SYSTEMS

- High recovery systems that can meet any hot water demand
- Systems can be designed to provide 50 to 100% back-up
- Heaters can be on & off fired, or sequenced to meet changing system demands
- Sequenced multi-unit systems that employ relatively small storage tanks are ideal for applications with constant, yet fluctuating hot water demands

#### MULTI-TANK SYSTEMS

- For applications with low ceiling heights or unique installation challenges

#### OPTIONAL DUAL ENERGY SOURCE CAPABILITY

- Ac-U-Temp storage tanks can be specified with heat exchangers; allows winter/summer heating operation
- Both, water-to-water, or steam-to-water heat exchangers are available in both single wall and double wall
- Complete control packages can be factory installed for hook-up and run capability
- Electric Back-up - Heavy-duty electric water heater elements and controls can be specified for up to 3,000 KW; 100% electric back-up
- Provides hot water even during natural gas curtailments

#### LIMITED WARRANTY OUTLINE

- If the heat exchanger modules should fail within 5 years, under the terms of the warranty, A. O. Smith will furnish a replacement part; installation, labor, handling and local delivery extra. If the tank should leak any time during the first 5 years, under terms of the warranty, A. O. Smith will repair or replace the tank; installation, labor, handling and local delivery extra. **THIS OUTLINE IS NOT THE WARRANTY.** For complete information, consult the written warranties or A. O. Smith.

## MODELS HWT-300 THRU HWT-670

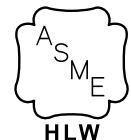

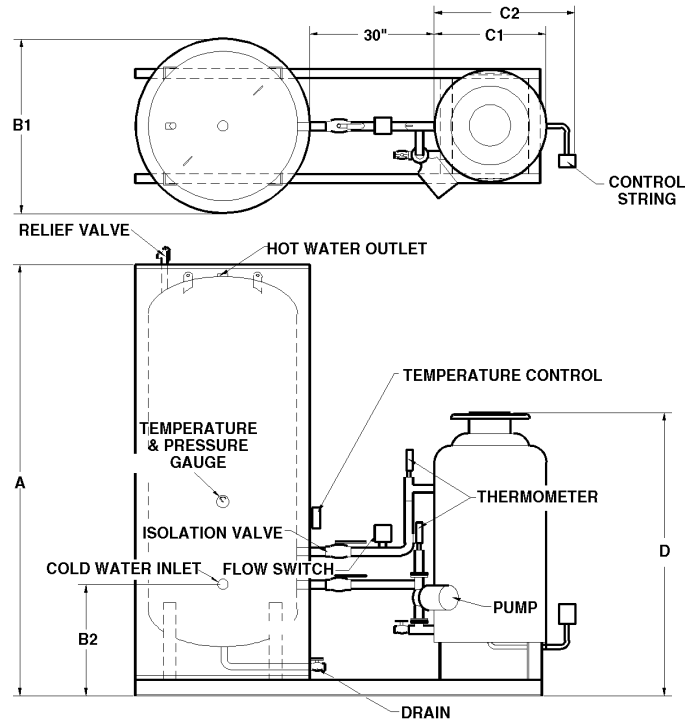

**CONFIGURATION V**

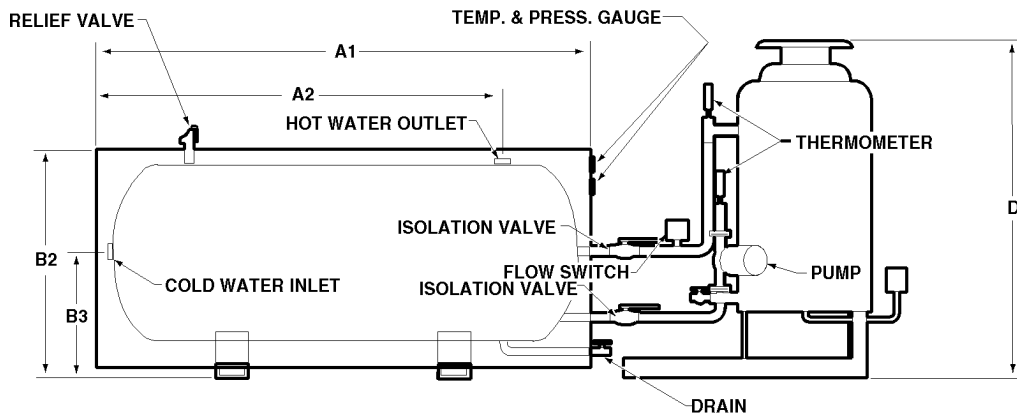
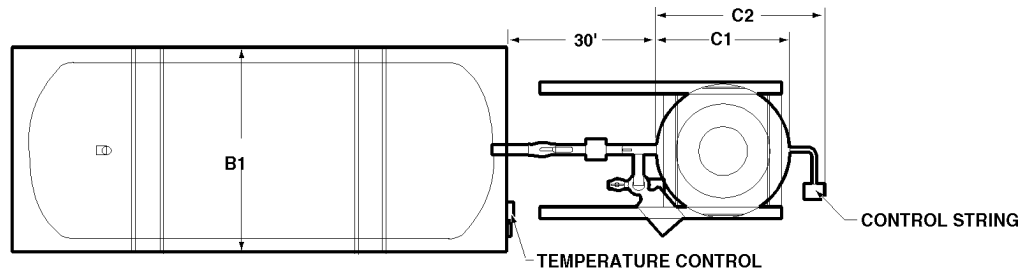

**CONFIGURATION H**

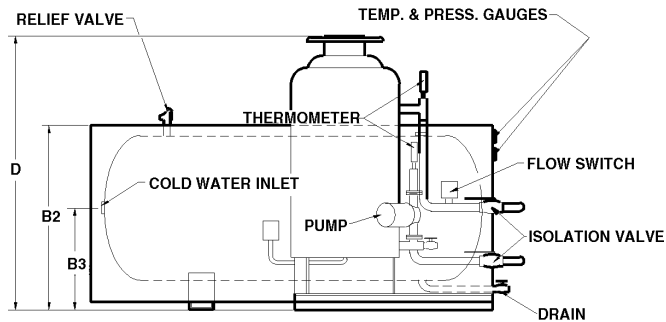
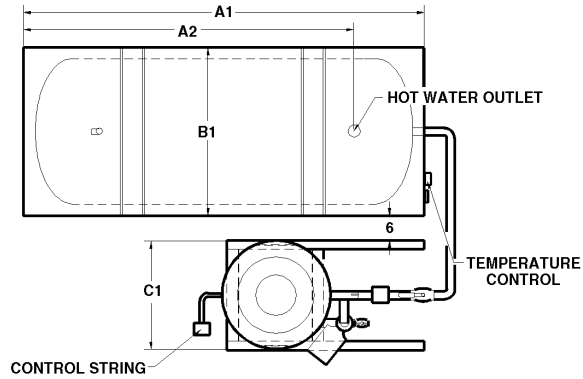

**CONFIGURATION S**

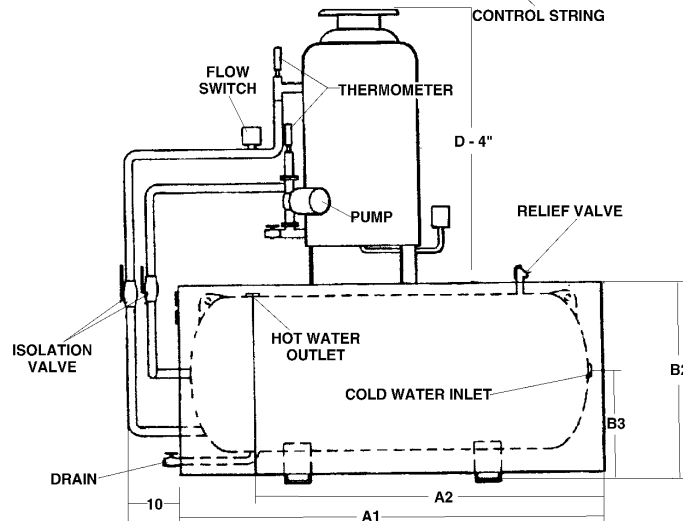
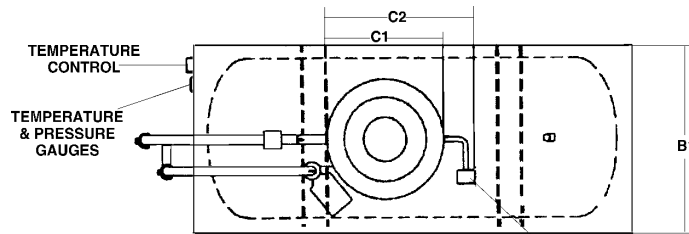

**CONFIGURATION P**



# Hot Water Supply Systems

**MODEL TO SPECIFY:**

**HW T - 670 - TJH - 500 A - S**

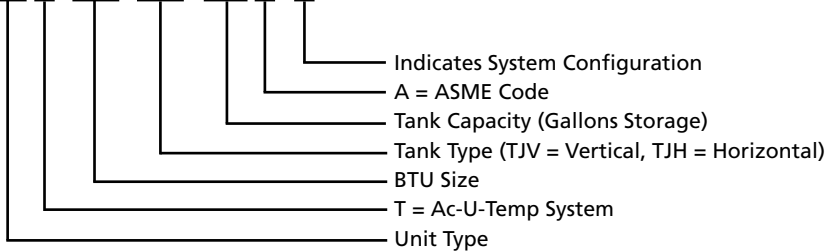

HEATER DATA					
	HW-300	HW-399	HW-420	HW-520	HW-670
<b>LENGTH (C2)</b>	25 1/4	27	27	27	27
<b>WIDTH (C1)</b>	30 1/4	32	32	34	34
<b>HEIGHT (D)</b>	67	59	59	71	67
<b>INLET SIZE</b>	1 1/4	1 1/2	1 1/2	2	2
<b>GAS INLET</b>	3/4	1	1	1	1

VERTICAL VESSEL DATA											
	TJ-80A	TJV-120	TJV-140	TJV-200	TJV-250	TJV-350	TJV-400	TJVT-500	TJV-500	TJV-750	TJV-1000
<b>HEIGHT (A)</b>	66 1/4	66	88	84	96	99	107	101	86	118	150
<b>WIDTH (B1)</b>	28	28	30	36	36	42	42	48	54	54	54
<b>INLET HEIGHT (B2)</b>	15	15	19 1/2	21	21	22 1/2	22 1/2	24	25 1/2	25 1/2	25 1/2
<b>INLET SIZE</b>	2	2	2 1/2	2 1/2	2 1/2	2 1/2	2 1/2	3	3	3	3
<b>OUTLET SIZE</b>	2	2	2 1/2	2 1/2	2 1/2	2 1/2	2 1/2	3	3	3	3

HORIZONTAL VESSEL DATA							
	TJH-200	TJH-350	TJH-400	TJHT-500	TJH-500	TJH-750	TJH-1000
<b>LENGTH (A1)</b>	77	93	99	94	79	111	143
<b>OUTLET DIM (A2)</b>	59	72 1/2	72 1/2	73	56 1/2	88 1/2	120 1/2
<b>WIDTH (B1)</b>	36	42	42	48	54	54	54
<b>HEIGHT (B2)</b>	41	47	47	53	59	59	59
<b>INLET HEIGHT (B3)</b>	21	24	24	27	30	30	30
<b>INLET SIZE</b>	2 1/2	2 1/2	2 1/2	3	3	3	3
<b>OUTLET SIZE</b>	2 1/2	2 1/2	2 1/2	3	3	3	3

**SUGGESTED SPECIFICATION**

The Hot Water Supply System - shall consist of A. O. Smith Ac-U-Temp® factory assembled system Model No. \_\_\_\_\_. System shall be completely factory assembled and shall include the A. O. Smith copper heat exchanger circulating water heater(s), with input of \_\_\_\_\_ BTU/H for \_\_\_\_\_ gas and recovery capacity of \_\_\_\_\_ gph, and the A. O. Smith glass-lined (cement/epoxy) hot water storage tank with \_\_\_\_\_ gallons capacity for \_\_\_\_\_ mounting (vertical-horizontal). System shall include properly sized circulator, inlet and outlet thermometers, tank temperature thermometer, relief valve, and tank temperature control. Entire system shall be rigidly mounted on welded steel skid base and shipped assembled to job site (Ac-U-Temp systems employing tanks too large for shipping as an assembled unit, will be shipped with the tank mounted on a split bolt-together skid).

See HW Circulating Water Heater Specification Sheet or go to [www.hotwater.com](http://www.hotwater.com).

Circulating Water Heater(s) and storage tank(s) shall have a 5 year limited warranty against corrosion as outlined in the written warranty.

NOTE: Custom supply systems also available, consult factory.

For Technical Information and Automated Fax Service, call 800-527-1953. A. O. Smith Corporation reserves the right to make product changes or improvements without prior notice.