

How to install your ecobee3 lite smart thermostat



Be happy

You have joined a growing community of people who want to conserve energy, save money, and do something good for our planet.

Let's get started!



**Download the ecobee
app for customized
installation instructions.**



Or continue reading!

First things first. Here's what you'll find in the box.

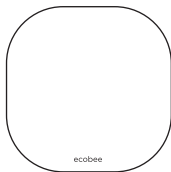

ecobee3 lite smart thermostat

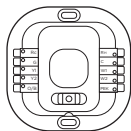

Backplate

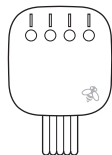

Power Extender Kit (PEK)

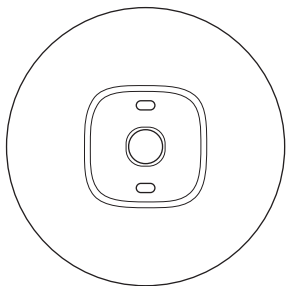

Trim plate

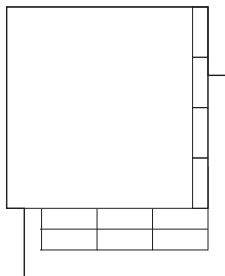

Install guide (this booklet) and wire labels



Screws



Drywall plugs

You'll also need these tools:

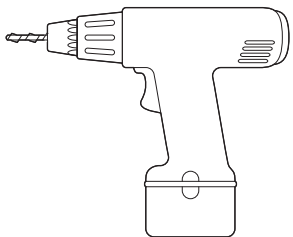

Drill for mounting anchors
(3/16" drill bit)



Small flathead
screwdriver



Phillips
screwdriver

OPTIONAL

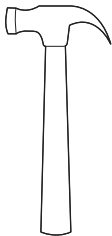

Hammer



Pencil

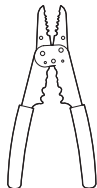

Wire stripper

Guide 1 or Guide 2? Start here to find out.

The steps in this section will help you decide which install guide you'll use to complete the installation.



These icons indicate useful tips, important reminders, and warnings.

STEP 1

Power off your Heating, Ventilation, and Air Conditioning (HVAC) system by using the master switch or circuit breaker box. This is important for your safety.

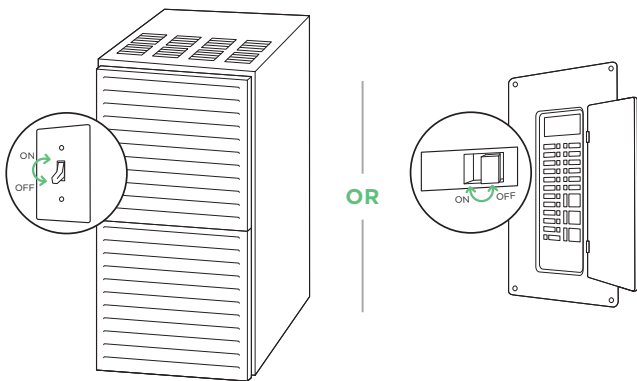

TIP:

Look for your master switch or circuit breaker box in the basement, attic, utility closet, or behind a wall panel near the thermostat.

STEP 2

Confirm your system is off by turning on your heat (during winter) or your AC (during summer). Wait a few minutes – you should not feel air coming from your vents.

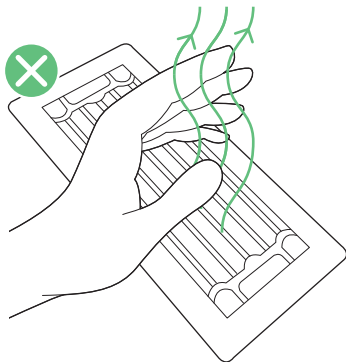
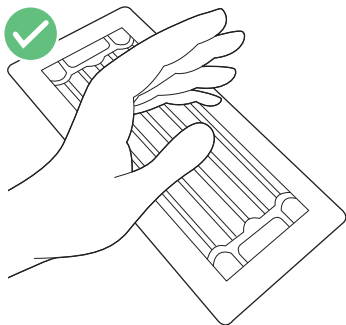

TIP:

If you have a boiler, check to see that the main flame is extinguished.

STEP 3

Remove your old thermostat cover from the wall.

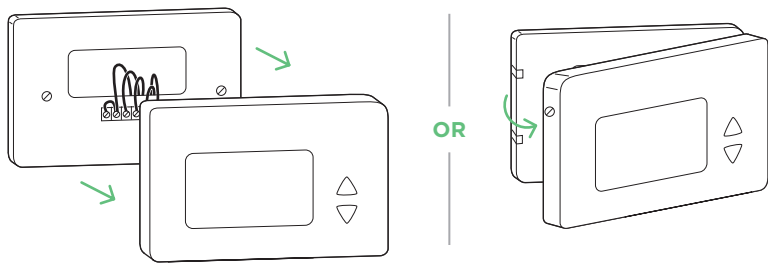

TIP:

Many thermostats simply pop off or unclip from the base, while others may have screws that you will need to remove.

✓ CHECKPOINT: COMPATIBILITY

Does your old thermostat's backplate have any of these indicators?

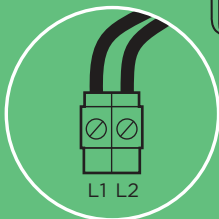
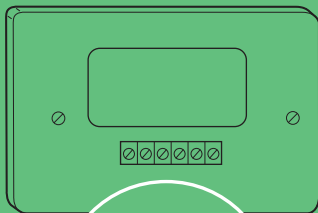

L1 L2



WARNING
HIGH VOLTAGE

110 VAC
OR
120 VAC
OR
240 VAC

YES

**Sadly, you might
not be compatible**

You can double check here:
ecobee.com/compatibility

NO

**Great, please
continue to
the next page**

STEP 4

Take a picture of the wires connected to the terminals of your old thermostat. You may need to reference this photo later on.

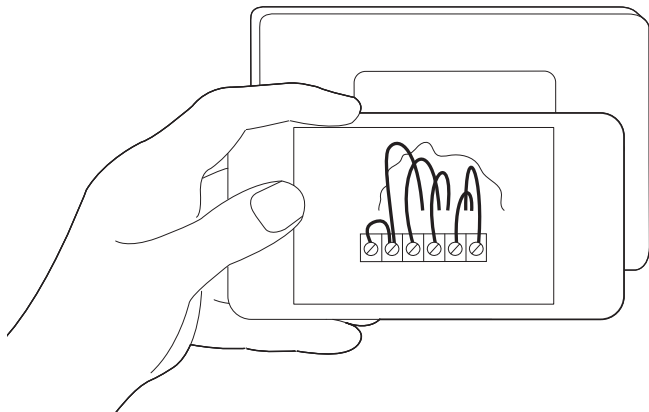

WARNING:

ecobee3 lite smart thermostat is designed for 24VAC with a 2A maximum current. Do not connect it to line (high) voltage or millivolt systems.

✓ CHECKPOINT: C WIRE

Do you have a C wire connected to your old thermostat?

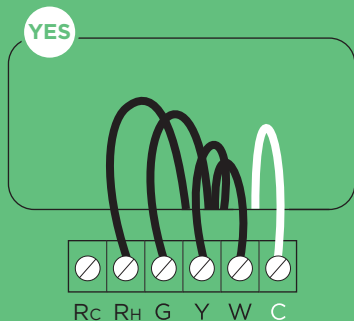

OR

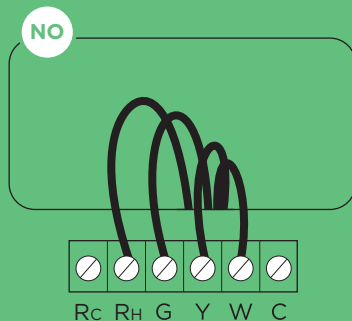

YES

Continue to
Guide 1

NO

Continue to
Guide 2

Install your ecobee with a C wire

If you have a C wire, it will power your ecobee. You won't need the Power Extender Kit included in the box.

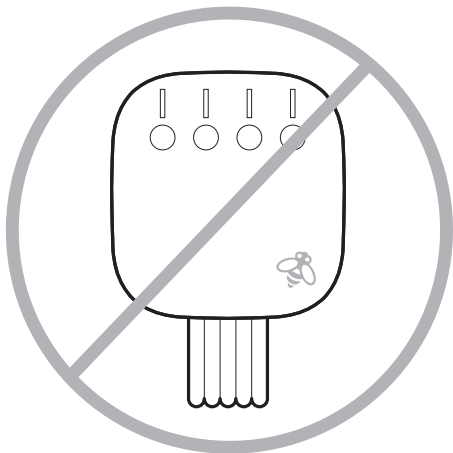

✓ CHECKPOINT: DON'T SKIP AHEAD

Have you completed steps 1 - 4 in the 'Start Your Install' section?

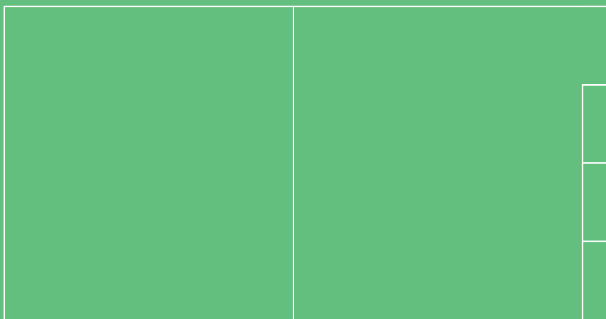

YES

Continue to
the next page

NO

Return to step 1
in 'Start Your Install'

STEP 5

Carefully disconnect and label the wires from your old thermostat one at a time, using the labels provided.

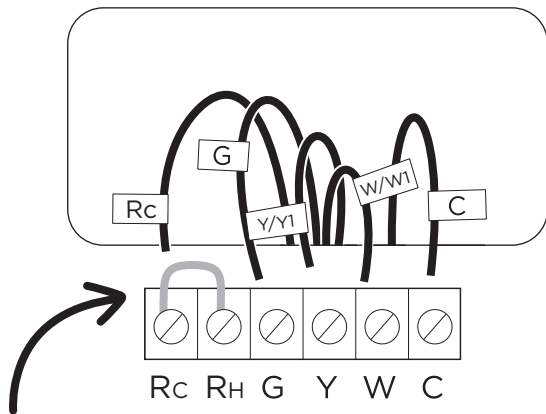

TIP:

If you have a jumper between Rc, RH, or R, leave it alone. Only label the wires that run from your wall into a terminal block.

STEP 6

Unscrew the mounting plate of your old thermostat to remove it from the wall.

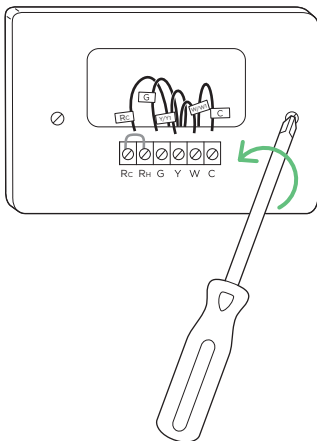

WARNING:

Be careful, as some thermostats may contain mercury. Recycle your old thermostat safely with your local hazardous waste facility.

STEP 7

Decide if you want to use the trim plate with your ecobee. The trim plate is useful if you want to hide marks or holes left on the wall by your old thermostat.

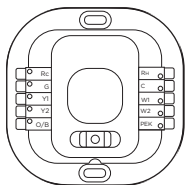

OR

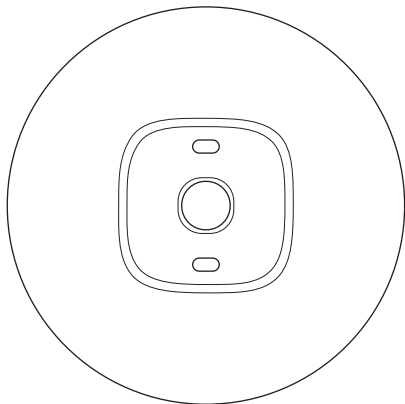

STEP 8: OPTIONAL

If using the trim plate, align the mounting holes on the trim plate and backplate and press them into place together.

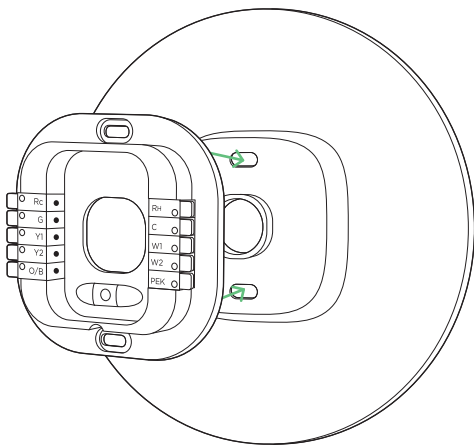

STEP 9

Pull the wires through the hole in the middle of the backplate and then attach the backplate to the wall using the drywall anchors and screws provided.

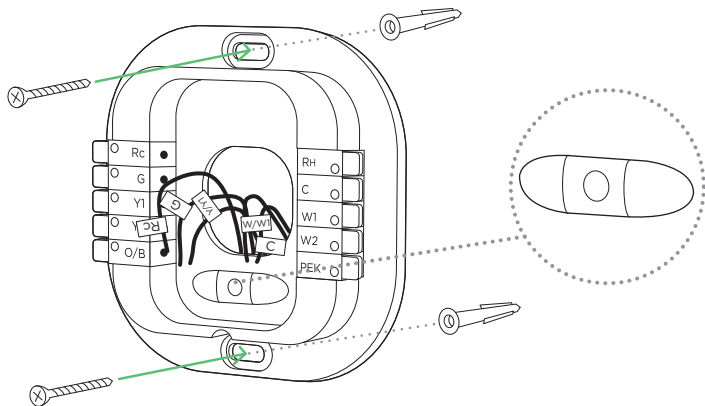

TIP:

Use a 3/16" drill bit to drill a hole for the drywall plugs.

✓ CHECKPOINT: INSERT YOUR R WIRE(S)

Do you have more than one R wire?
(That includes R, Rc, and Rh)

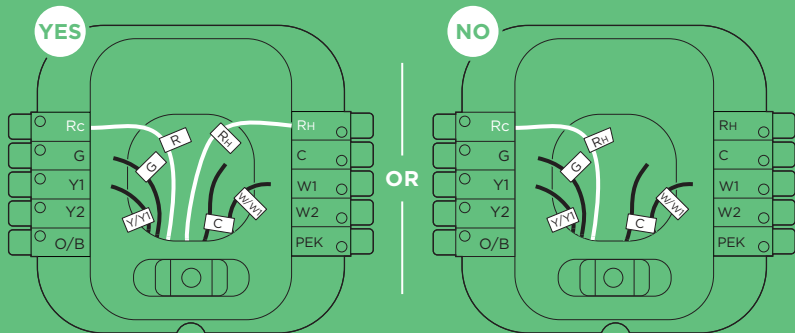

YES

Insert your wires:
R OR Rc → Rc
Rh → Rh

NO

Insert your single
R, Rc, or Rh wire into
the Rc terminal.

STEP 10

Insert your remaining wires into the *side* (not the front) of their corresponding terminal blocks.

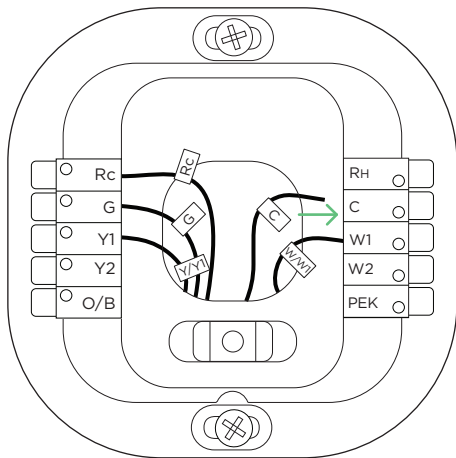
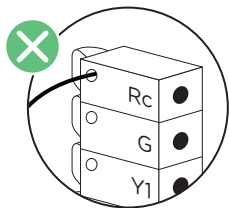
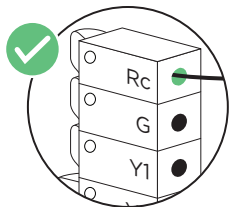

TIP:

Press the terminal block levers to insert the wires more easily.

STEP 11

Tug on the wires gently to ensure they are securely connected.

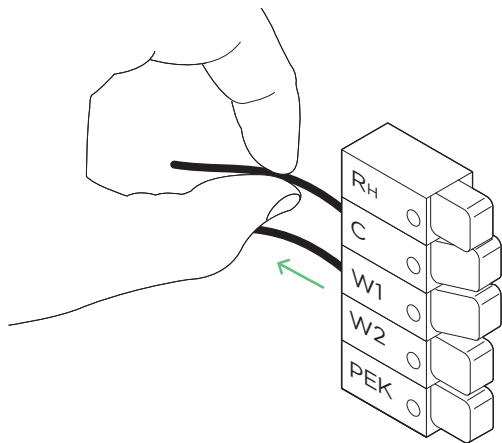

TIP:

When a wire has been connected correctly, the lever on that block will lower.

STEP 12

Carefully push any excess wire back into the hole and ensure there are no drafts coming from the hole(s) in the wall.

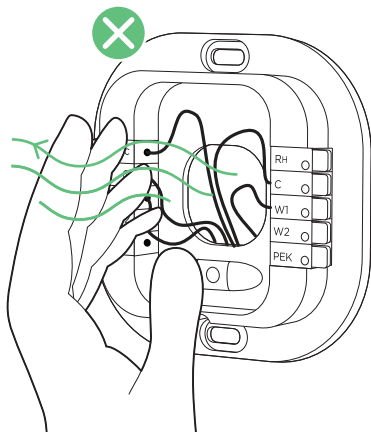
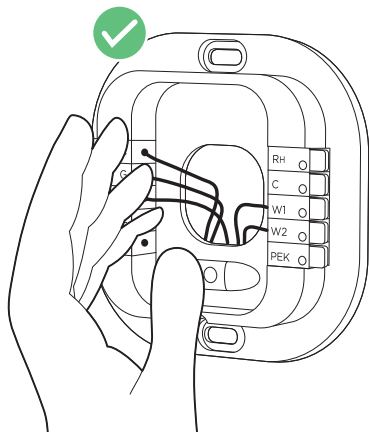

TIP:

Large holes behind your thermostat will affect temperature readings. Prevent drafts by covering the hole(s).

STEP 13

Gently press your ecobee into the backplate until it 'clicks' into place.

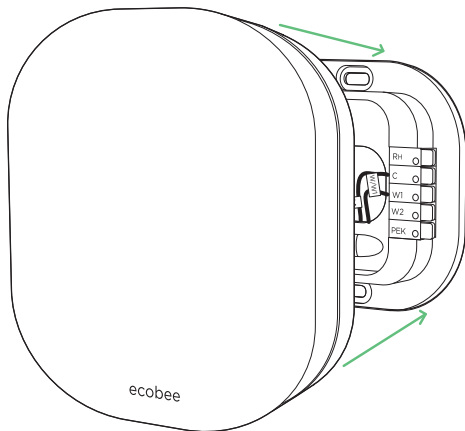

TIP:

If the thermostat 'rocks' or is not flush with the wall, be sure the excess wires are pushed all the way into the wall.

STEP 14

Turn the power to your HVAC system back on using the master switch or at the circuit breaker box.

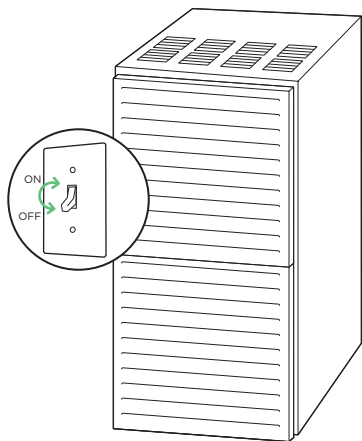

OR

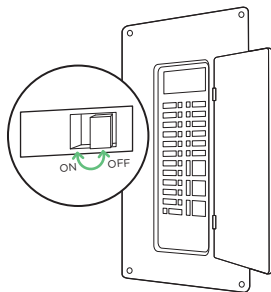

STEP 15

Say hi to your new ecobee! The screen will power on and guide you through the set-up and registration.

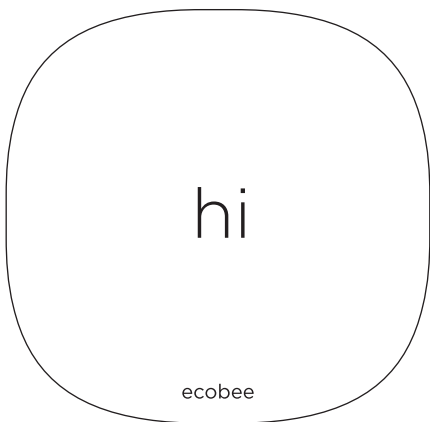

TIP:

If your thermostat does not power on, please see the troubleshooting tips in the 'Extras' section.

ALL DONE!

Congratulations, you did it!

To complete your set-up,
follow the instructions on
your ecobee screen.



GUIDE 2

Install your ecobee without a C wire

If you don't have a C wire, you'll need to use the Power Extender Kit (PEK) included to reliably power your ecobee.

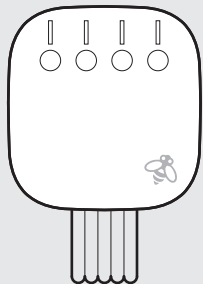

✓ CHECKPOINT: DON'T SKIP AHEAD

Have you completed steps 1 – 4 in the 'Start Your Install' section?

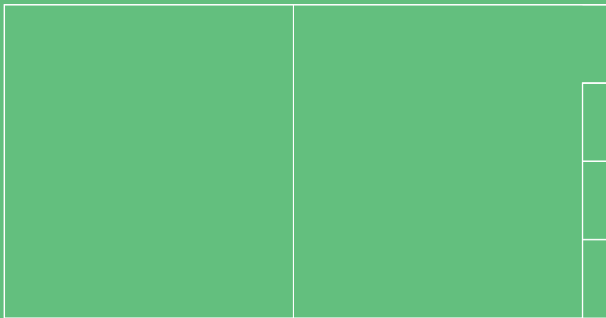

YES

Continue to
the next page

NO

Return to step 1
in 'Start Your Install'

✓ CHECKPOINT: 3 OR 4 WIRES

The Power Extender Kit requires your system to have the following wires:

4 wires: W/W1, Y/Y1, G, and R (or R_c, or R_H)

OR

3 wires: Y/Y1, G, and R (or R_c, or R_H)

Do you have these wires?

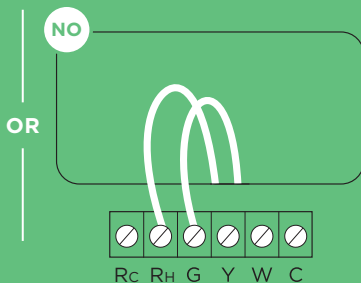
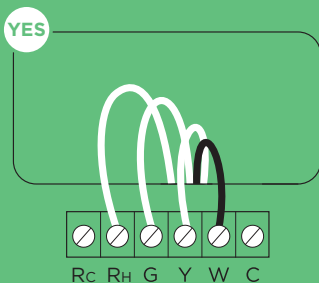

OR

YES

**Continue to
the next page**

The Power Extender Kit
will work with your system!

NO

Give us a call

Looks like you have one or more
wires missing. **Please contact ecobee
support for more information.**

1.877.932.6233 or
support@ecobee.com.

STEP 5

Take your Power Extender Kit, wire labels, tools, your smartphone, and go to your HVAC system.

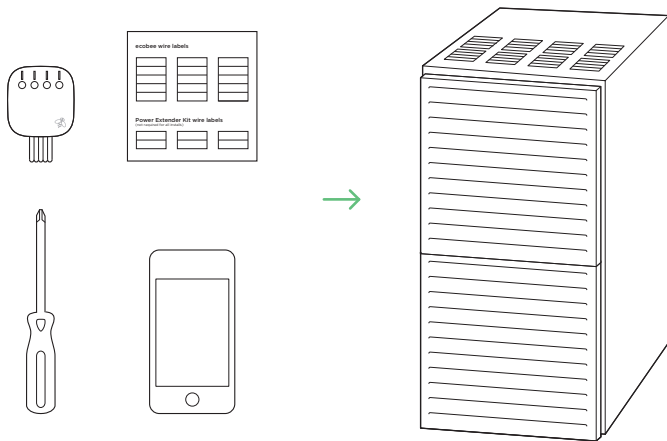

TIP:

Your HVAC system can most often be found in your basement or your attic.

STEP 6

Open your HVAC system's cover to reveal the control board.

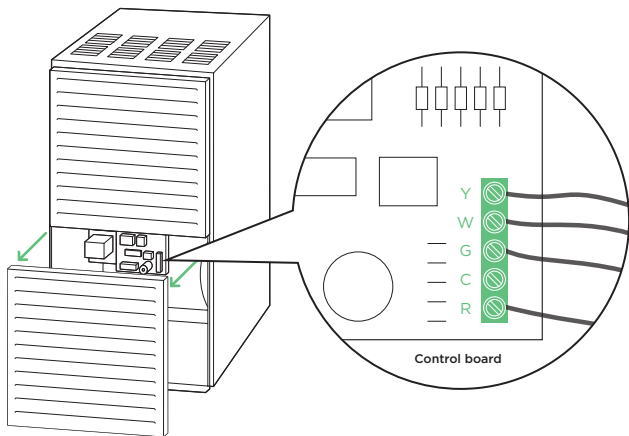

WARNING:

HVAC systems contain high voltage wires. Use caution when working with the control board.

STEP 7

Take a picture of the wires connected to your control board. You may need to reference this photo later on.

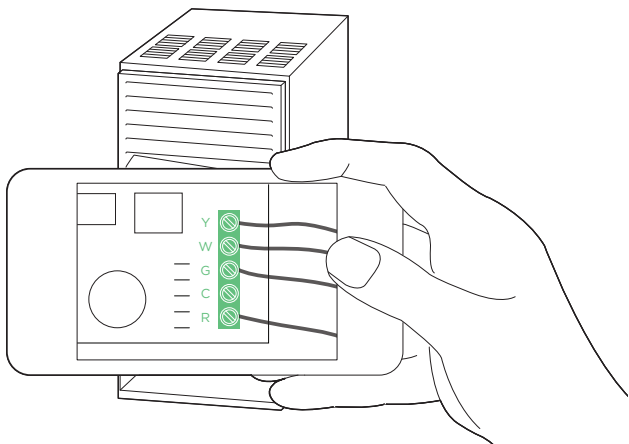

STEP 8

Label only the R, Y or Y1, G and W, or W1 wires with the matching labels provided. If you have more than one wire going into these terminals, only label those coming from your thermostat.

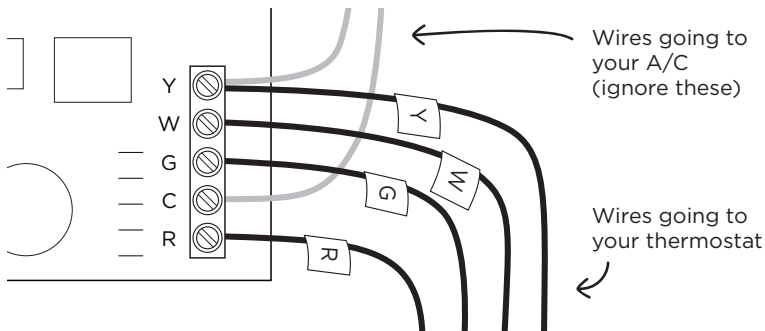

TIP:

If you have wires connected to both R_C and R_H terminals at the control board you may have a two transformer system. Please contact support to help you with installation: **1.877.932.6233** or support@ecobee.com.

STEP 9

Disconnect the labeled R, Y, G, and W wires from the control board.

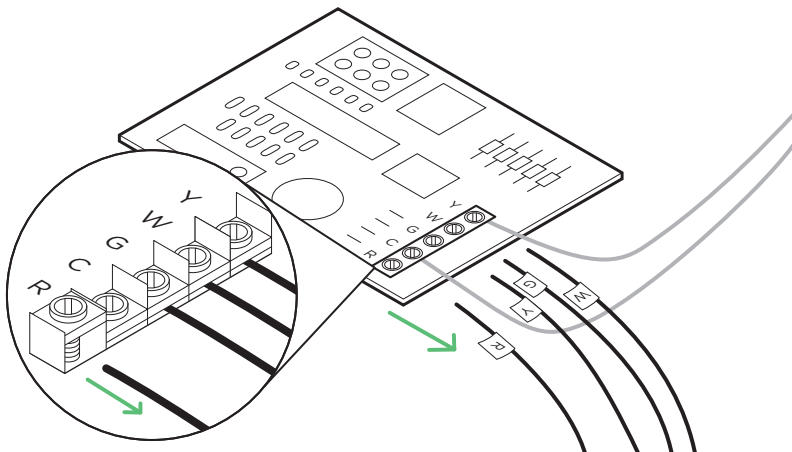

STEP 10

Connect the wires you disconnected from the control board into their matching gray terminal blocks on the Power Extender Kit.

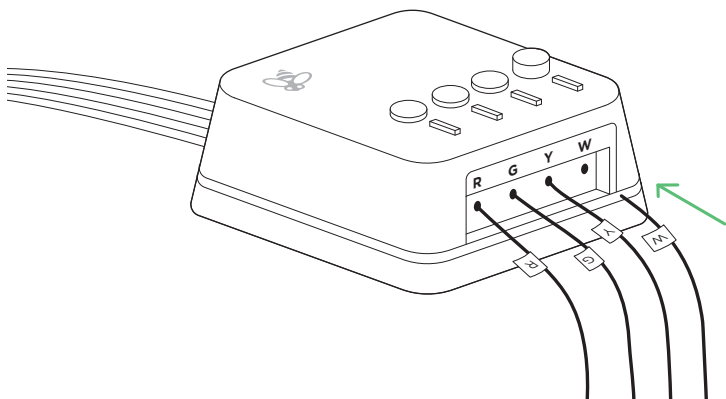

TIP:

Press the buttons to insert the wires more easily.

STEP 11

Tug on the wires gently to ensure they are securely connected.

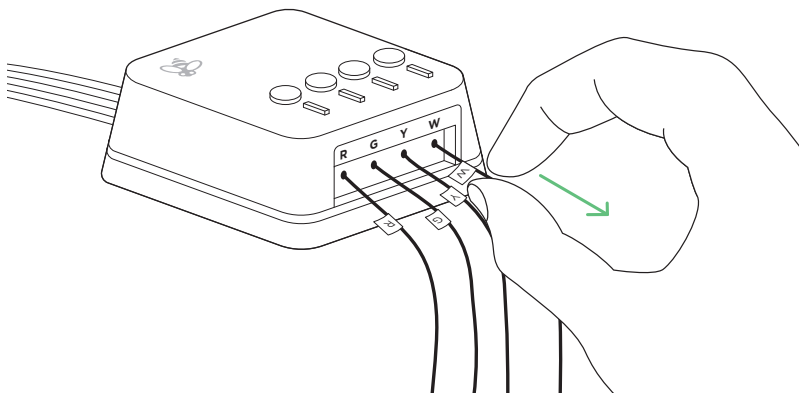

TIP:

When a wire has been connected correctly, the button on that block will lower.

STEP 12

Connect the 5 white wires coming out of the Power Extender Kit to the corresponding terminals on your control board.

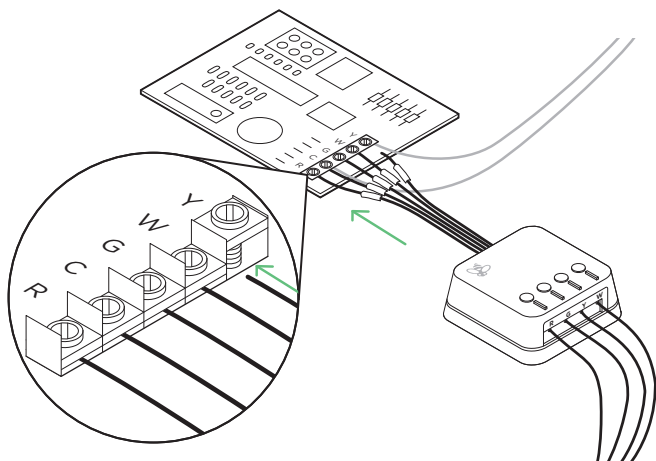

TIP:

Once again, tug on the wires gently to ensure they are securely connected.

✓ CHECKPOINT: POWER EXTENDER KIT

Check that you have installed the Power Extender Kit correctly. It should be installed between your thermostat wiring and your control board.

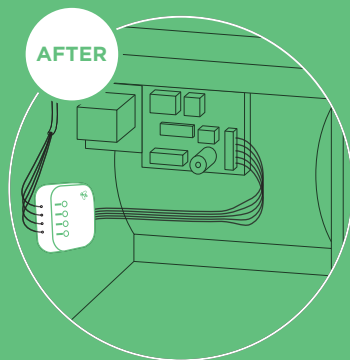
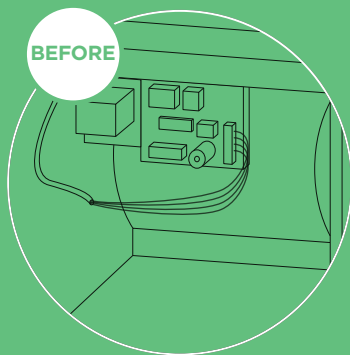

STEP 13

Mount the Power Extender Kit inside your HVAC system, taking care not to strain the wires. Close the HVAC cover panel securely and return to your thermostat.

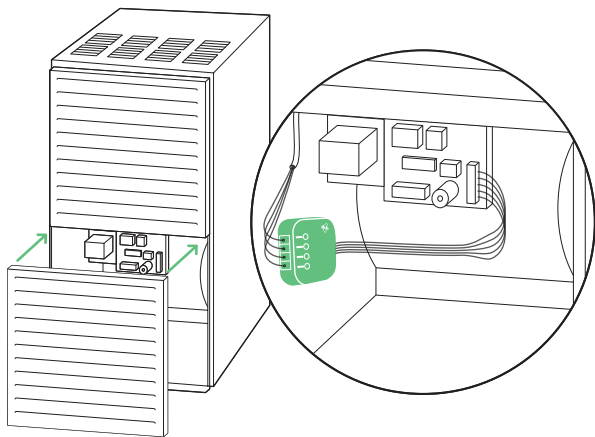

TIP:

Make sure your HVAC panel is fully closed. Some systems will not turn on if the cover panel has not been closed properly.

STEP 14

Back at your thermostat: Carefully disconnect and label the wires from your old thermostat one at a time, using the labels provided.

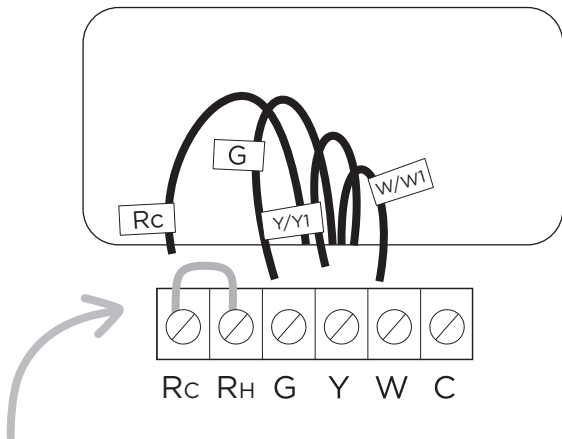

TIP:

If you have a jumper between Rc, RH, or R, leave it alone. Only label the wires that run from your wall into a terminal block.

STEP 15

Unscrew the mounting plate of your old thermostat to remove it from the wall.

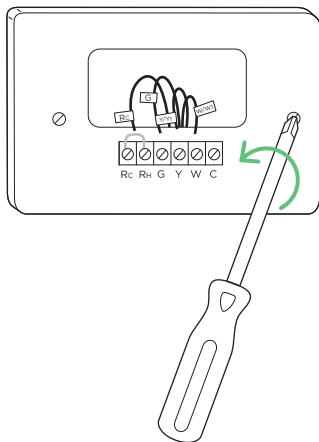

WARNING:

Be careful, as some thermostats may contain mercury. Recycle your old thermostat safely with your local hazardous waste facility.

STEP 16

Decide if you want to use the trim plate with your ecobee. The trim plate is useful if you want to hide marks or holes on the wall left by your old thermostat.

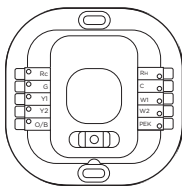

OR

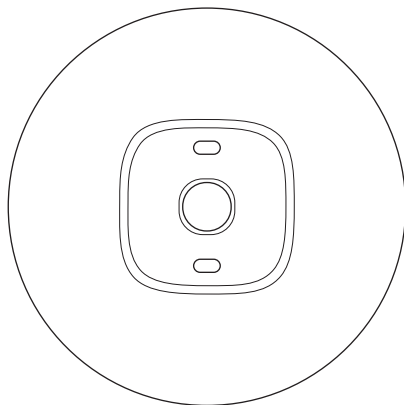

STEP 17: OPTIONAL

If using the trim plate, align the mounting holes on the trim plate and backplate and press them into place together.

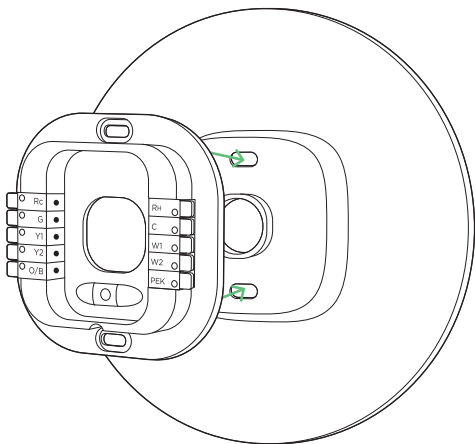

STEP 18

Pull the wires through the hole in the middle of the backplate and then attach it to the wall using the drywall anchors and screws provided.

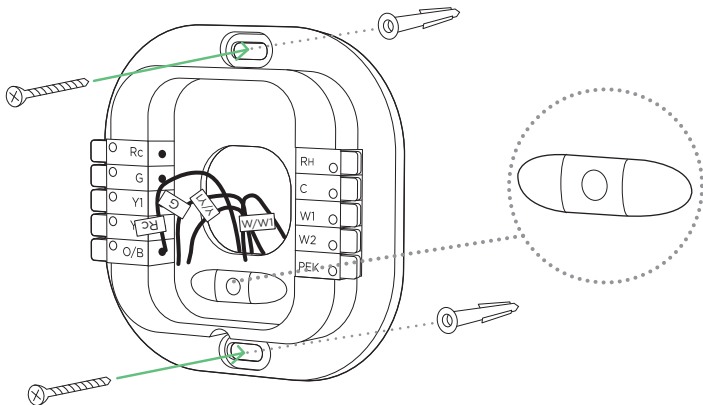

TIP:

Use a 3/16" drill bit to drill a hole for the drywall plugs.

STEP 19

First, connect these 3 wires as shown:

R/Rc/Rh → Rc

G → C

Y → PEK

Then, connect any remaining wires to their corresponding terminal.

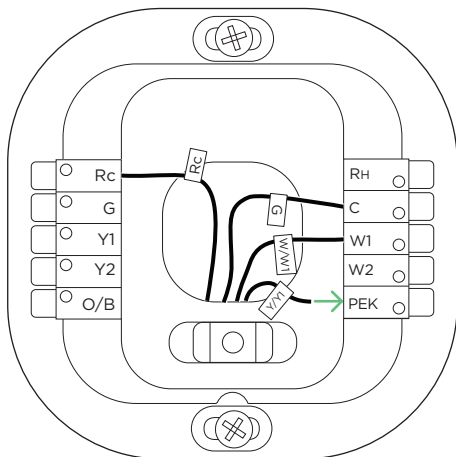
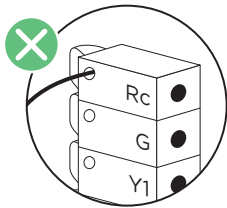
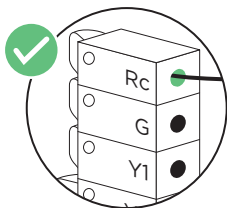

TIP:

Press the terminal block levers to insert the wires more easily.

STEP 20

Tug on the wires gently to ensure they are securely connected.

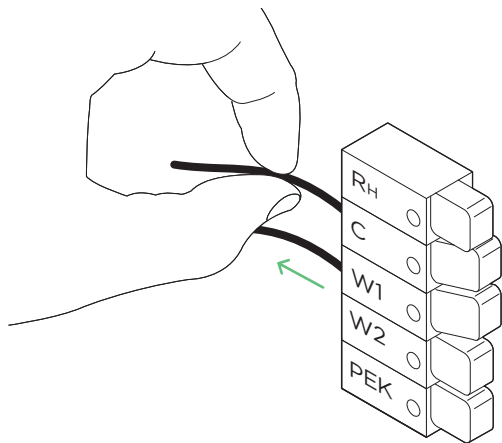

TIP:

When a wire has been connected correctly, the lever on that block will lower.

STEP 21

Carefully push any excess wires back into the hole and ensure there are no drafts coming from the hole(s) in the wall.

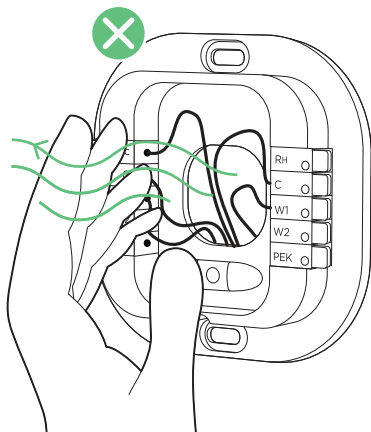
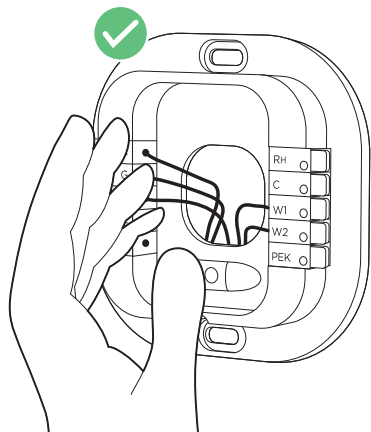

TIP:

Large holes behind your thermostat will affect temperature readings. Prevent drafts by covering the hole(s).

STEP 22

Gently press your ecobee into the backplate until it 'clicks' into place.

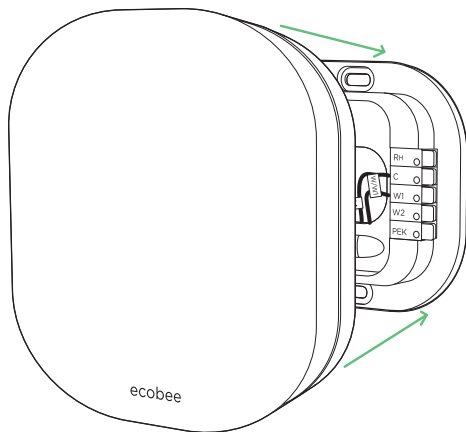

TIP:

If the thermostat 'rocks' or is not flush with the wall, be sure the excess wires are pushed all the way into the wall.

STEP 23

Turn the power to your HVAC system back on using the master switch or at the circuit breaker box.

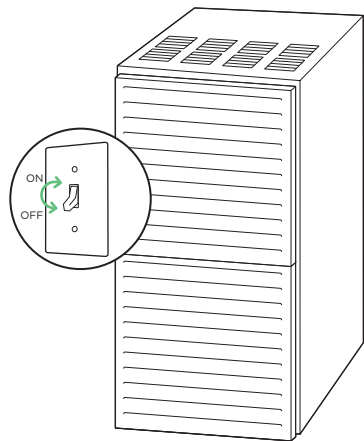

OR

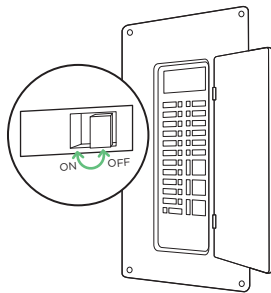

STEP 24

Say hi to your new ecobee! The screen will power on and guide you through the set-up and registration.

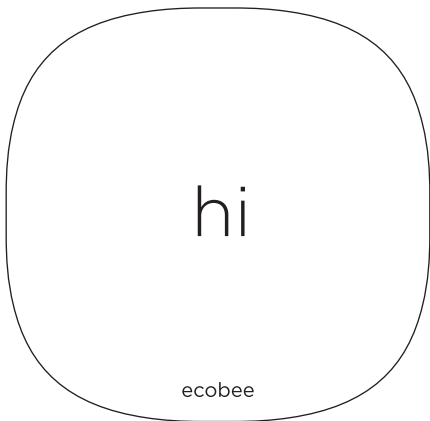

TIP:

If your thermostat does not power on, please see the troubleshooting tips in the 'Extras' section.

ALL DONE!

Congratulations, you did it!

To complete your set-up,
follow the instructions on
your ecobee screen.



EXTRAS

In here you'll find:

Troubleshooting

Meet your ecobee

Wiring diagrams

Warranty and Legal

TROUBLESHOOTING

If your ecobee doesn't turn on, please try these steps:

1. Check that all wires are properly inserted into the terminal blocks at the thermostat. Tug on the wires to ensure they are not loose.
2. Make sure your HVAC cover panel is closed. Some systems will not turn on if the cover panel has not been closed properly.

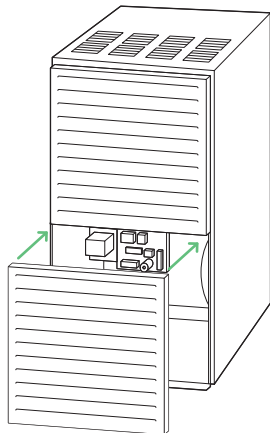
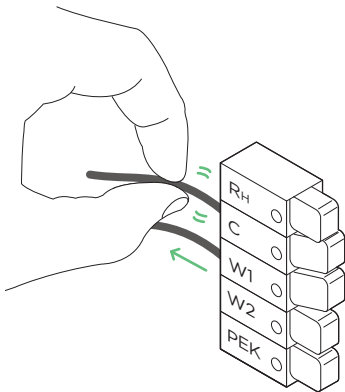

TROUBLESHOOTING

3. If you have only one R wire (either R, Rc, or RH), make sure it's inserted into the Rc terminal.

R (or Rc or RH) → Rc

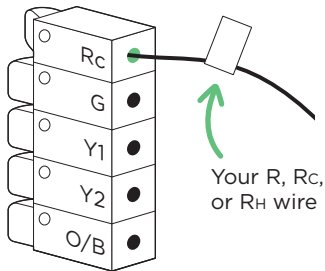

4. If you installed the Power Extender Kit, make sure you inserted the wires into the correct terminals:

R (or Rc or RH) → Rc

G → C

Y → PEK

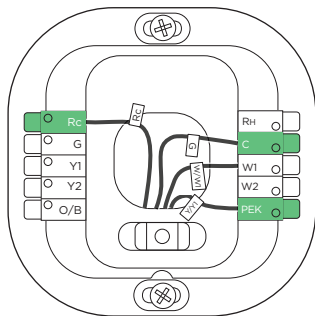

ecobee support is here to help:

Call:
1 877 932 6233 (North America)
1 647 428 2220 (International)

Email:
support@ecobee.com

MEET YOUR ECOBEE

Here's what you'll see on the home screen:

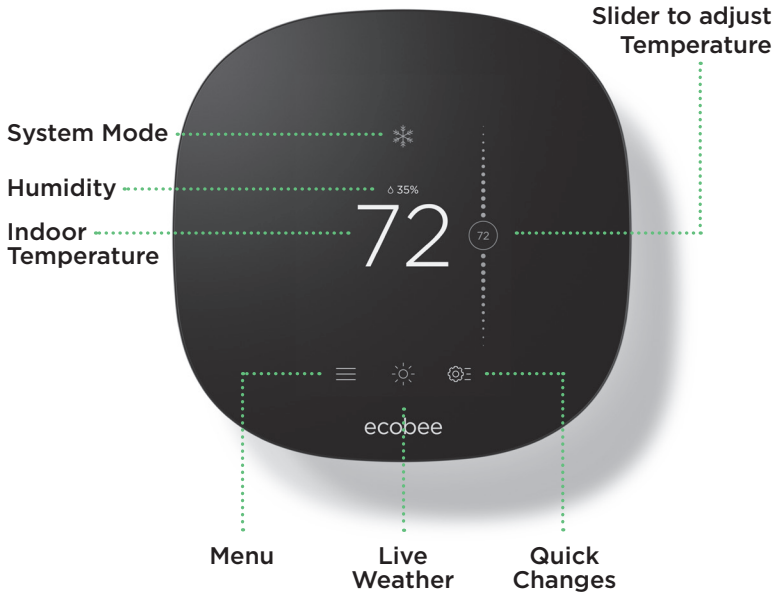

MEET YOUR ECOBEE

And here's what that means:

System Mode

Shows your current ecobee setting [heat/cool/auto/off]

Humidity

Shows the indoor humidity in your home

Temperature

Shows the temperature in your home

Menu

Allows you to control your system, schedule a vacation, and more

Weather

Shows the local weather and forecast for the week

Quick Changes

Touch this button to easily switch from Home and Away

Slider to adjust Temperature

Slide the bubble up or down to adjust your preferred temperature

MEET YOUR ECOBEE

These system mode icons are shown on the Home screen and in Quick Changes.



Heat

Your system is in heat mode. A white icon means your system is off. An orange icon means your system is running.



Cool

Your system is in cool mode. A white icon means your system is off. A blue icon means your system is running.



Fan

Your fan is currently running.



Auto

Your system is in Auto mode, meaning your system will heat or cool as required.

MEET YOUR ECOBEE

More common icons you'll find:

Home Screen



Menu



Menu
(with notification)



Weather



Quick Changes

Menu



Registration



System



Reminders
and Alerts



Schedule



Vacation



Settings



Comfort Settings



About

Comfort Settings



Home



Away



Sleep



Custom 1
(of 5)

WIRING DIAGRAM

Conventional heating and cooling (up to 2 stages each)

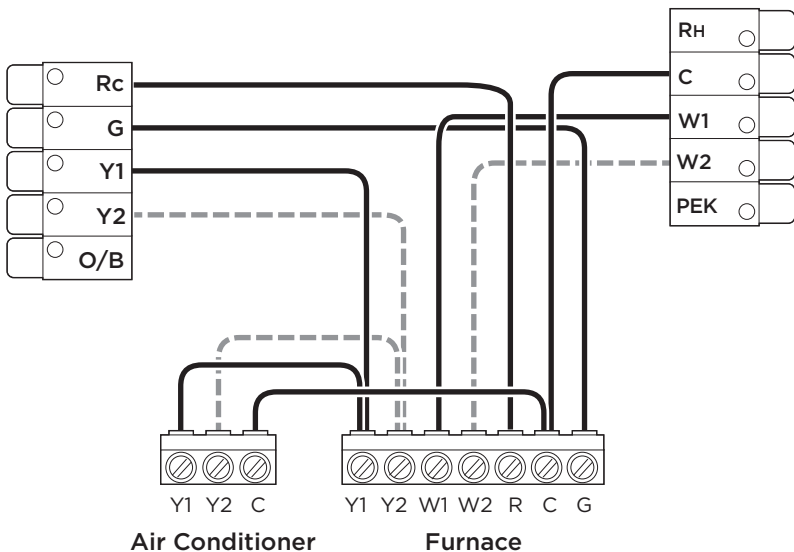

NOTE:

Do not connect any jumper wires between Rc and RH. ecobee does this automatically. The R wire needs to go into the Rc terminal on your ecobee.



Stage 2 heat and cool, if applicable

WIRING DIAGRAM

Heat pump (air or geothermal) with auxiliary heat

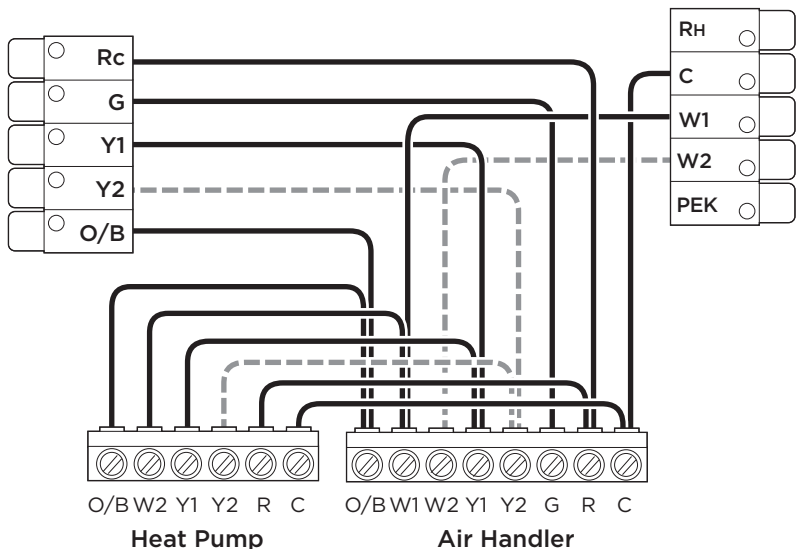

NOTE:

Do not connect any jumper wires between Rc and Rh. ecobee does this automatically. The R wire needs to go into the Rc terminal on your ecobee.



Stage 2 compressor and auxiliary heat, if applicable

WIRING DIAGRAM

Boiler or radiant system with air handler and conventional cooling or heating

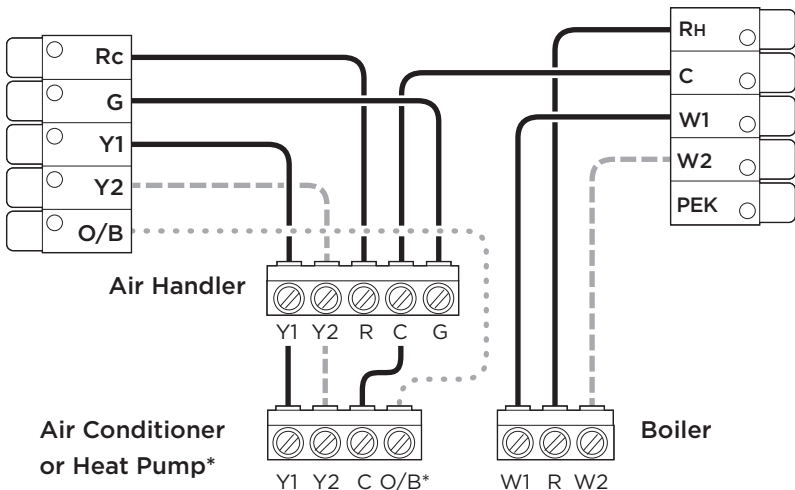

NOTE:

Do not connect any jumper wires between Rc and Rh. ecobee does this automatically. The R wire needs to go into the Rc terminal on your ecobee.

.....
*Reversing valve for heat pumps only

Stage 2 heat and cool, if applicable

WIRING DIAGRAM

Power Extender Kit thermostat wiring

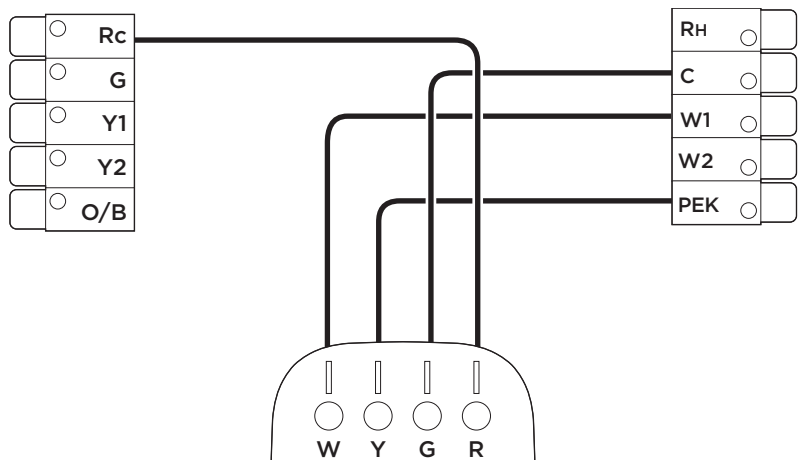

Power Extender Kit
(at your HVAC system)

NOTE:

Do not connect any jumper wires between Rc and RH. ecobee does this automatically. The R wire needs to go into the Rc terminal on your ecobee.

LEGAL

Approvals

This product was designed and built in accordance to RoHS directive 2002/95/EC and contains no hazardous substances as defined by this directive.

FCC Compliance Statement

Compliance Notice:

This equipment has been tested and found to comply with the limits for a Class B digital device, pursuant to part 15 of the FCC Rules. These limits are designed to provide reasonable protection against harmful interference in a residential installation. This equipment generates, uses and can radiate radio frequency energy and, if not installed and used in accordance with the instructions, may cause harmful interference to radio communications. However, there is no guarantee that interference will not occur in a particular installation. If this equipment does cause harmful interference to radio or television reception, which can be determined by turning the equipment off and on, the user is encouraged to try to correct the interference by one or more of the following measures:

- Reorient or relocate the receiving antenna.
- Increase the separation between the

equipment and receiver.

- Connect the equipment into an outlet on a circuit different from that to which the receiver is connected.
- Consult the dealer or an experienced radio/TV technician for help.

This device complies with part 15 of FCC rules. Operation is subject to the following two conditions:

1. This device may not cause harmful interference.
2. This device must accept any interference received, including interference that may cause undesired operation.

Change or modifications that are not expressly approved by the manufacturer could void the user's authority to operate the equipment.

RF Exposure Information:

This equipment complies with FCC radiation exposure limits set forth for an uncontrolled environment. In order to avoid the possibility of exceeding the FCC radio frequency exposure limits, human proximity to the antenna shall not be less than 20cm during normal operation.

Industry Canada (IC)

Compliance Notice:

This device complies with Industry Canada license-exempt RSS standard(s).

Operation is subject to the following two conditions:

1. This device may not cause interference.
2. This device must accept any interference, including interference that may cause undesired operation of the device.

This Class B digital apparatus complies with Canadian ICES-003.

RF Exposure Statement:

This equipment complies with IC RSS-102 radiation exposure limits set forth for an uncontrolled environment. This transmitter must be installed to provide a separation distance of at least 20 cm from all persons and must not be collocated or operating in conjunction with any other antenna or transmitter.

Industrie Canada (IC)**Avis de conformité :**

Le présent appareil est conforme aux CNR d'Industrie Canada applicables aux appareils radio exempts de licence.

L'exploitation est autorisée aux deux conditions suivantes :

1. *l'appareil ne doit pas produire de brouillage.*
2. *l'utilisateur de l'appareil doit accepter*

tout brouillage radioélectrique subi, même si le brouillage est susceptible d'en compromettre le fonctionnement.

Cet appareil numérique de la classe B est conforme à la norme NMB-003 du Canada.

Énoncé sur l'exposition aux fréquences radio :

Cet équipement est conforme aux limites d'exposition aux fréquences radio d'IC RSS-102 définies pour un environnement non contrôlé. Cet émetteur doit être installé à au moins 20 cm de toute personne et ne doit pas être colocalisé ou fonctionner en association avec une autre antenne ou émetteur.

FCC ID: WR9EBSTAT3LT01
IC ID: 7981A-EBSTAT3LT01
CAN ICES-3 (B)/NMB-3(B)

Warning: Changes or modifications not expressly approved by ecobee Inc. could void the user's authority to operate the equipment.

3-Year Limited Warranty

ecobee warrants that for a period of three (3) years from the date of purchase by the consumer ("Customer"), the ecobee3 lite smart thermostat (the "Product") shall be free of defects in materials and workmanship under normal use and service. During the warranty period, ecobee shall, at its option, repair or replace any defective

Products, at no charge. Any replacement and/or repaired device are warranted for the remainder of the original warranty or ninety (90) days, whichever is longer. A proof-of-purchase will be required from the Customer in order for ecobee to provide a replacement and/or repaired device. This Warranty is valid only for Product installed in the country in which it is purchased.

If the product is defective, call Customer Service at 1-877-932-6233. ecobee will make the determination whether a replacement product can be sent to you or whether the product should be returned to the ecobee head office. In the event of a failure of a Product, Customer may:

- a. if Customer did not purchase the Product directly from ecobee, contact the third party contractor from whom the Product was purchased to obtain an equivalent replacement product, provided the contractor determines that the returned Product is defective and Customer is otherwise eligible to receive a replacement product;
- b. contact ecobee directly for service assistance at 1-877-932-6233 and ecobee will make the determination whether an advance equivalent replacement Product can be sent to Customer with return shipping supplies (in which case a hold shall be put on Customer's credit card for the value of the replacement Product until ecobee has received the

defective Product). Product should be returned to the ecobee head office. If the returned Product is found by ecobee to be defective and Customer is otherwise eligible to receive a replacement product, no amount shall be charged to Customer's credit card; or

- c. ship the defective Product directly to ecobee, in which case Customer shall contact ecobee directly at 1-877-932-6233, so ecobee can make the required shipping arrangements. Upon receipt of the defective Product, ecobee will ship an equivalent replacement product to Customer, provided the returned Product is found by ecobee to be defective and Customer is otherwise eligible to receive a replacement product.

This warranty does not cover removal or reinstallation costs and shall not apply if the damages were found to be caused by something other than defects in materials or workmanship, including without limitation, if the Product:

- was operated/stored in abnormal use or maintenance conditions;
- is repaired, modified or altered, unless ecobee expressly authorizes such repair, modification or alteration in writing;
- was subject to abuse, neglect, electrical fault, improper handling, accident or acts of nature;
- was not installed by a licensed Heating

Ventilating and Air Conditioning (HVAC) contractor; or

- was installed improperly.

ecobee's sole responsibility shall be to repair or replace the Product within the terms stated above. ECOBEE SHALL NOT BE LIABLE FOR ANY LOSS OR DAMAGE OF ANY KIND, INCLUDING ANY SPECIAL, INCIDENTAL OR CONSEQUENTIAL DAMAGES RESULTING, DIRECTLY OR INDIRECTLY, FROM ANY BREACH OF ANY WARRANTY, EXPRESS OR IMPLIED, OR ANY OTHER FAILURE OF THIS PRODUCT. Some US states and Canadian provinces do not allow the exclusion or limitation of incidental or consequential damages, so the above limitation or exclusion may not apply to you.

ecobee's responsibility for malfunctions and defects in materials and workmanship is limited to repair and replacement as set forth in this warranty statement. All express and implied warranties for the product, including but not limited to any implied warranties and conditions of merchantability and fitness for a particular purpose, are limited to the three-year duration of this limited warranty. No warranties, whether expressed or implied, will apply after the limited warranty period has expired. Some US states and Canadian provinces do not allow limitations on how long an implied warranty lasts, so this limitation may not apply.

ecobee neither assumes responsibility for nor authorizes any other person purporting to act on its behalf to modify or to change this warranty, nor to assume for it any other warranty or liability concerning this product.

This warranty gives you specific rights, and you may also have other rights which vary from jurisdiction to jurisdiction. If you have any questions regarding this warranty, please write to ecobee customer service.

Legal Notice

Use of the HomeKit logo means that an electronic accessory has been designed to connect specifically to iPod, iPhone, or iPad, respectively, and has been certified by the developer to meet Apple performance standards. Apple is not responsible for the operation of this device or its compliance with safety and regulatory standards. Please note that the use of this accessory with iPod, iPhone, or iPad may affect wireless performance. Apple, iPhone, iPad, and iPod touch are trademarks of Apple Inc., registered in the U.S. and other countries. HomeKit is a trademark of Apple Inc.



We're here to help.

ecobee.com

support@ecobee.com

1.877.932.6233

© 2016 ecobee, Inc. All rights reserved. ecobee and the ecobee logo are trademarks of ecobee Inc., registered in the U.S. and other countries.



770-00038