

PARK HARBOR™

PHVL3092PC

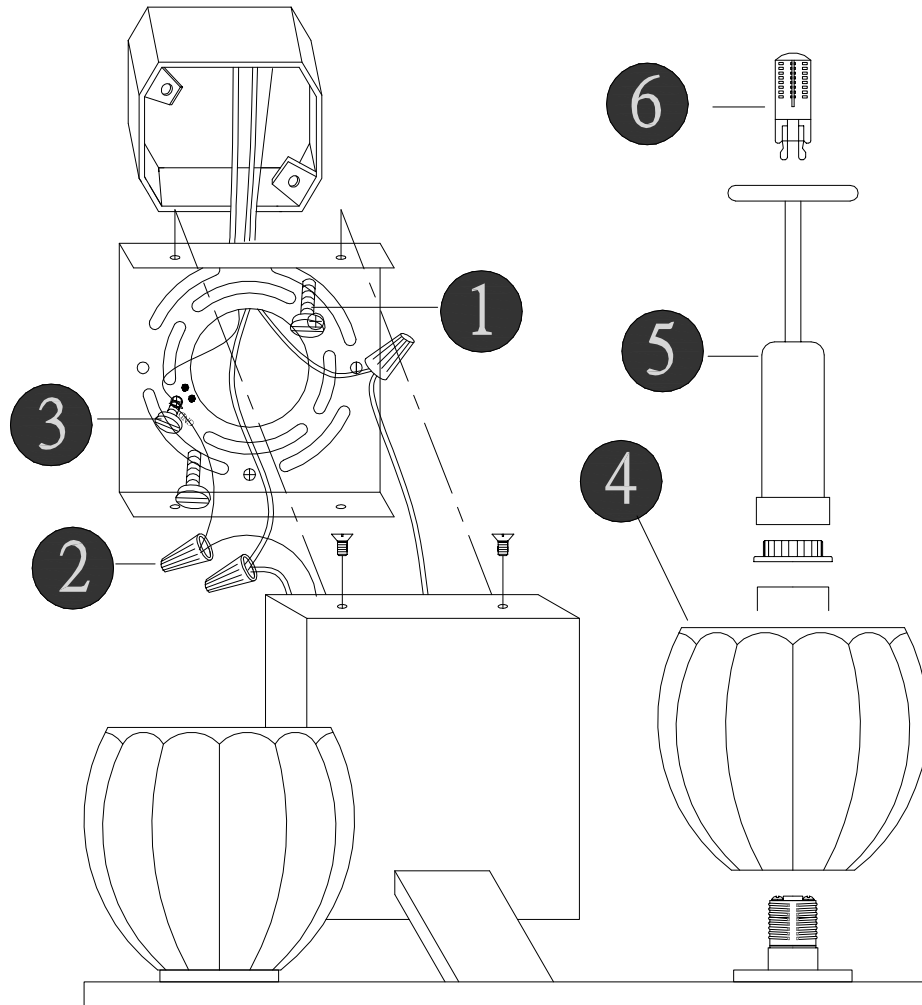
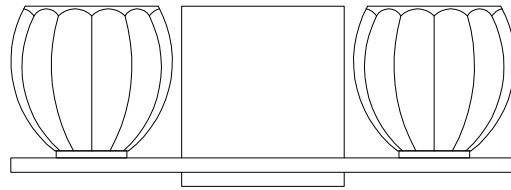

Swans Point Parts Breakdown

No.	Part Name	Spanish	French	Part No.
1	Mounting Screw (2pcs)	Tornillos de montaje (2pcs)	Vis de montage (2pcs)	PHSP309HDWRWTY
2	Wire Nut (3pcs)	Empalme plástico (3pcs)	Capuchon de connexion (3pcs)	
3	Ground Screw (1pc)	Tornillo a tierra (1pc)	Vis de borne de terre (1pc)	
4	Glass Shade (2pcs)	Pantalla de vidrio (2pcs)	Abat-jour en verre (2pcs)	PHSP309GLSWTY
5	Socket ring(G9)	Anillo de zócalo(G9)	Bague de douille(G9)	PHSPSO CRNGWTY
6	Bulb (2pcs)	Bombilla (2pcs)	Ampoule (2pcs)	PHSPPGBG9LEDWTY