



Position	Count	Description	Unit price
	-1	<p>UPS 50-60 SF</p>  <p>Product photo could vary from the actual product</p> <p>Product No.: 97523136 The pump is of the canned rotor type, i.e. pump and motor form an integral unit without shaft seal and with only two gaskets for sealing. The bearings are lubricated by the pumped liquid. The pump is characterized by:</p> <ul style="list-style-type: none"> * Ceramic shaft and radial bearings. * Carbon axial bearing. * Stainless steel rotor can and bearing plate. * Corrosion-resistant impeller, Composite, PES. * Stainless steel pump housing. <p>The motor is a 1-phase motor. No additional motor protection is required.</p> <p>Liquid: Liquid temperature range: 32 .. 230 °F Density: 62.4 lb/ft³</p> <p>Technical: Maximum operating pressure: 145 psi Approvals on nameplate: ETL, CSA</p> <p>Materials: Pump housing: Stainless steel DIN W.-Nr. 1.4301 Impeller: Composite, PES</p> <p>Installation: Maximum ambient temperature: 104 °F Ambient max at 176°F liquid: 176 °F Maximum operating pressure: 145 psi Flange standard: USA Oval Type of connection: S.S. Flange Pipe connection: 4 - Bolt Flange Pressure stage: 10</p>	On request



Company name: -
 Created by: -
 Phone: -
 Fax: -
 Date: -

Position	Count	Description	Unit price
		Port-to-port length: 8 1/2 in Electrical data: Number of poles: 2 Power input in speed 1: 260 W Power input in speed 2: 350 W Max. power input: 395 W Rated power - P2: 0.335 HP Main frequency: 60 Hz Rated voltage: 1 x 115 V Current in speed 1: 2.7 A Current in speed 2: 3.4 A Current in speed 3: 3.6 A Capacitor size - run: 40 µF/180 V Insulation class (IEC 85): H Others: Gross weight: 20.1 lb	

Description	Value
Product name:	UPS 50-60 SF
Product Number:	97523136
EAN number:	5700317647510
Technical:	
Speed Number:	3
Max flow:	124 US gpm
Head max:	21.3 ft
Maximum operating pressure:	145 psi
Approvals on nameplate:	ETL, CSA
Materials:	
Pump housing:	Stainless steel DIN W.-Nr. 1.4301
Impeller:	Composite, PES
Installation:	
Maximum ambient temperature:	104 °F
Ambient max at 176°F liquid:	176 °F
Maximum operating pressure:	145 psi
Flange standard:	USA Oval
Type of connection:	S.S. Flange
Pipe connection:	4 - Bolt Flange
Pressure stage:	10
Port-to-port length:	8 1/2 in
Liquid:	
Liquid temperature range:	32 .. 230 °F
Density:	62.4 lb/ft³
Electrical data:	
Number of poles:	2
Power input in speed 1:	260 W
Power input in speed 2:	350 W
Max. power input:	395 W
Rated power - P2:	0.335 HP
Main frequency:	60 Hz
Rated voltage:	1 x 115 V
Current in speed 1:	2.7 A
Current in speed 2:	3.4 A
Current in speed 3:	3.6 A
Capacitor size - run:	40 µF/180 V
Insulation class (IEC 85):	H
Motor protection:	CONTACT
Thermal protec:	internal
Controls:	
Pos term box:	9H
Others:	
Gross weight:	20.1 lb

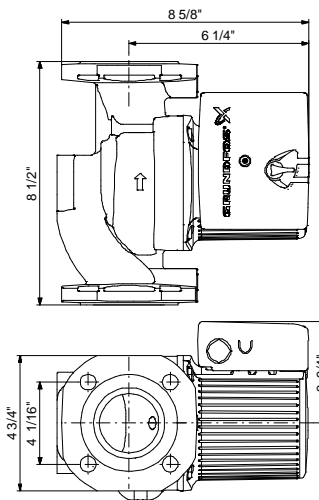
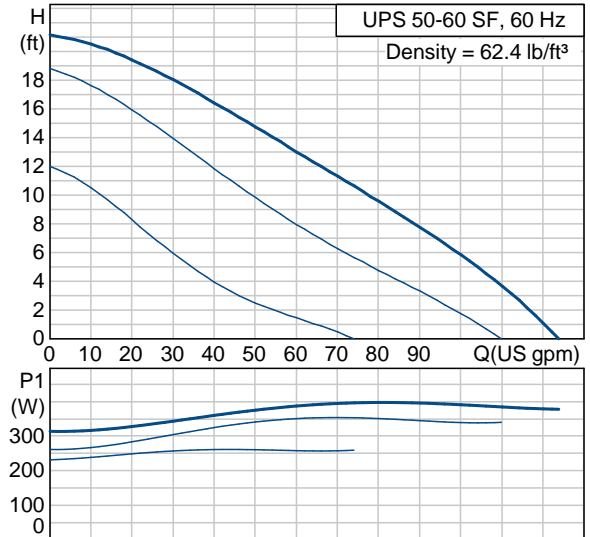

97523136 UPS 50-60 SF 60 Hz

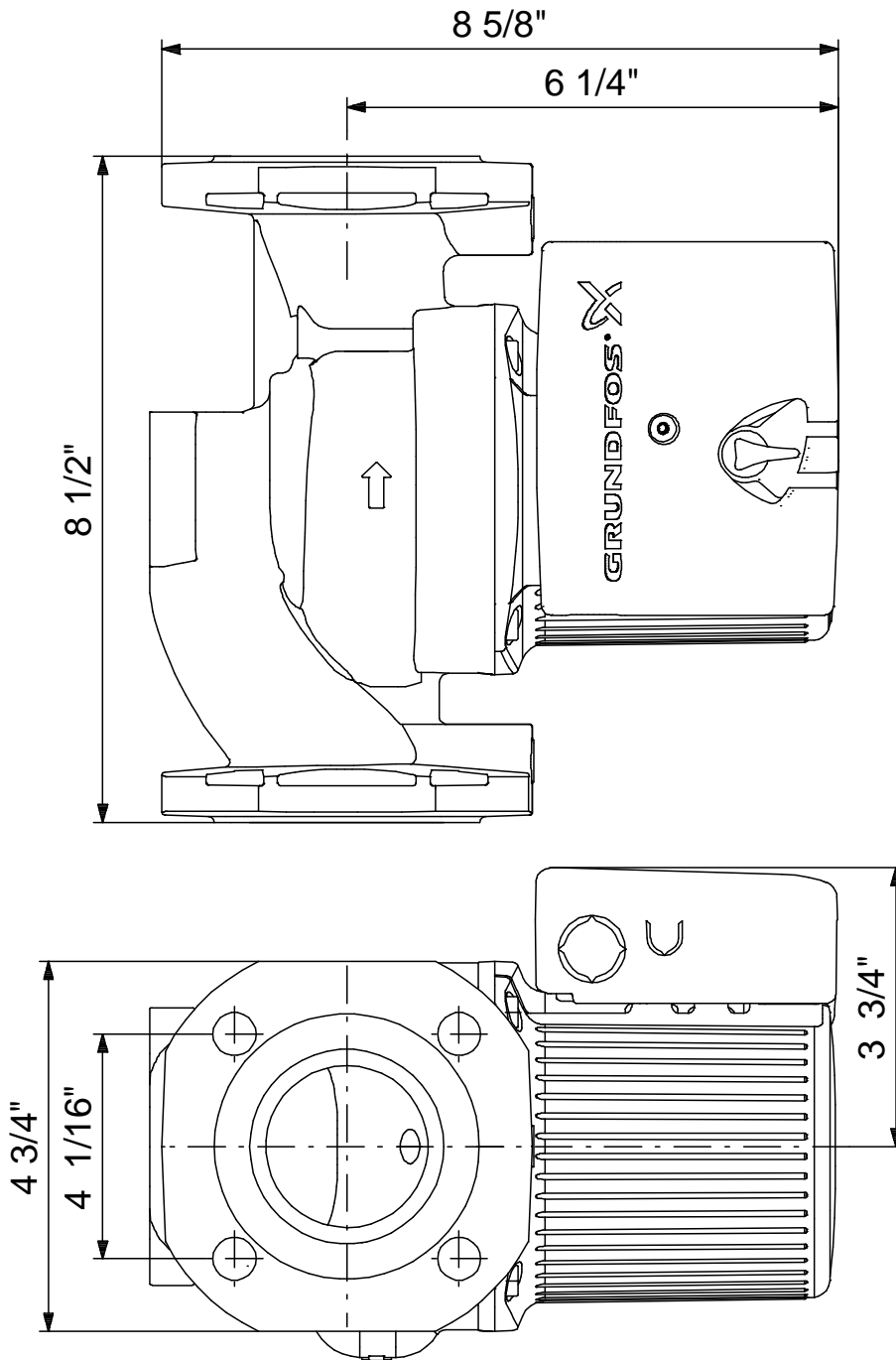

Note! All units are in [mm] unless others are stated.
Disclaimer: This simplified dimensional drawing does not show all details.