

Submitted Model No.: _____

Specific Features: _____

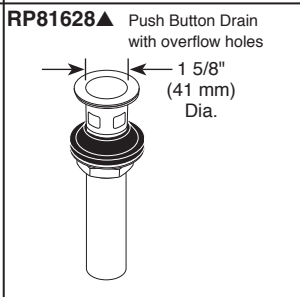
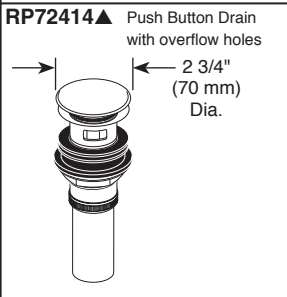
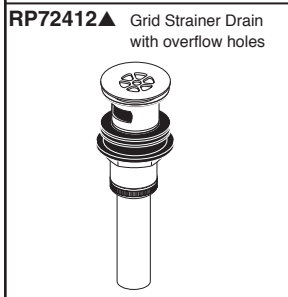
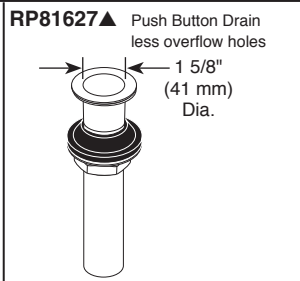
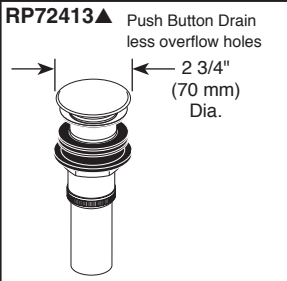
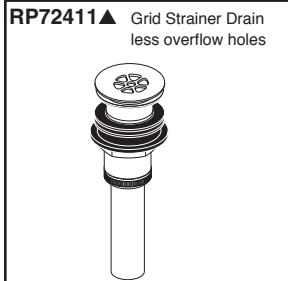
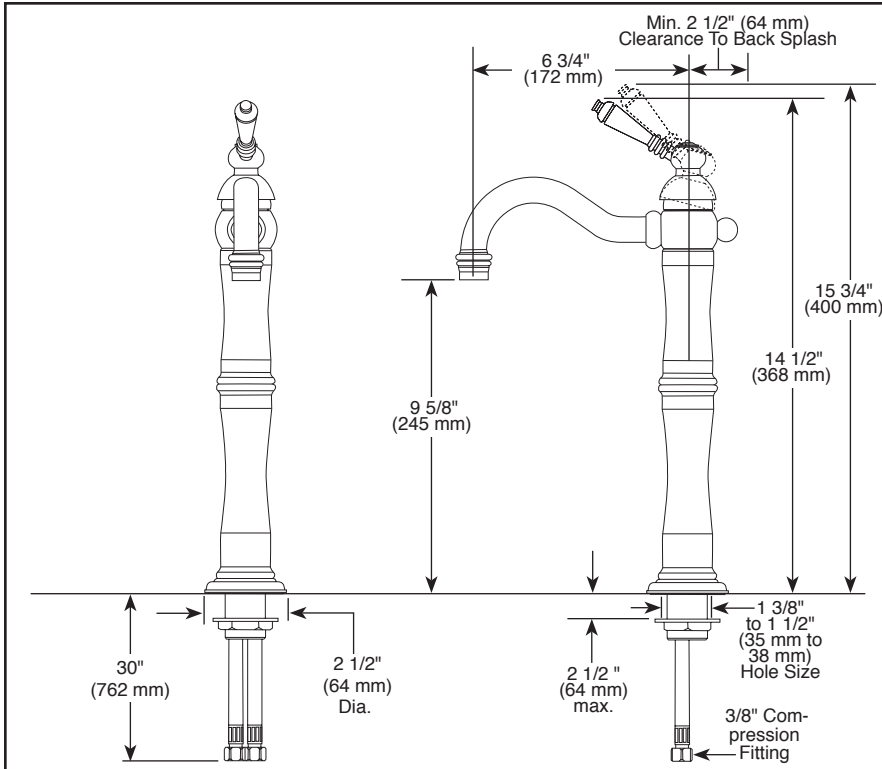

▲ Designate proper finish suffix

BRIZO®

LAVATORY FAUCET

- Tresa® Collection
- Single Handle Deck Mount

STANDARD SPECIFICATIONS:

- Max flow rate: 1.50 GPM @ 60 PSI, 5.68 L/Min @ 414 kPa
- Max flow rate (ECO models only): 1.20 GPM @ 60 PSI, 4.54 L/Min @ 414 kPa
- One hole mount
- Ceramic cartridge
- Solid brass fabricated body
- Drain sold separately

WARRANTY:

- Lifetime limited warranty on parts (other than electronic parts and batteries) and finishes: or, for commercial users, for 5 years from date of purchase.
- 5 year limited warranty on electronic parts (other than batteries); or, for commercial users, for 1 year from the date of purchase. No warranty is provided on batteries.



COMPLIES WITH:

- ASME A112.18.1 / CSA B125.1
- ASME A112.18.2 / CSA B125.2
- ☒ Indicates compliance to ICC/ANSI A117.1
- EPA WaterSense®
- Verified compliant with 0.25% weighted average Pb content regulations

Brizo Kitchen & Bath Company reserves the right (1) to make changes in specifications and materials, and (2) to change or discontinue models, both without notice or obligation. Dimensions are for reference only. See current full-line price book or www.brizo.com for finish options and product availability.
BSP-L-65436LF Rev. D

Brizo Kitchen & Bath Company
Indianapolis, Indiana 46280
A Division of Masco Corporation of Indiana
© 2016 Brizo Kitchen & Bath Company