

Features

- Lever handle.
- Trim only requires valve to complete.
- KOHLER finishes resist corrosion and tarnishing, exceeding industry durability standards by over two times.
- Integrates with Devonshire® collection of products.

Required Accessories

K-300-K High Flow Bath Valve
K-300-KR High Flow Valve w/ Rigid Connections
K-301-K ¾" High-Flow Bath Valve

Optional Accessories

1032704
1032705



ADA

Codes/Standards







ASME A112.18.1/CSA B125.1
ADA

KOHLER® Faucet Lifetime Limited Warranty

See website for detailed warranty information.

Available Color/Finishes

Color tiles intended for reference only.

Color	Code	Description
	CP	Polished Chrome
	SN	Vibrant® Polished Nickel
	PB	Vibrant® Polished Brass
	BN	Vibrant® Brushed Nickel
	BV	Vibrant® Brushed Bronze
	2BZ	Oil-Rubbed Bronze

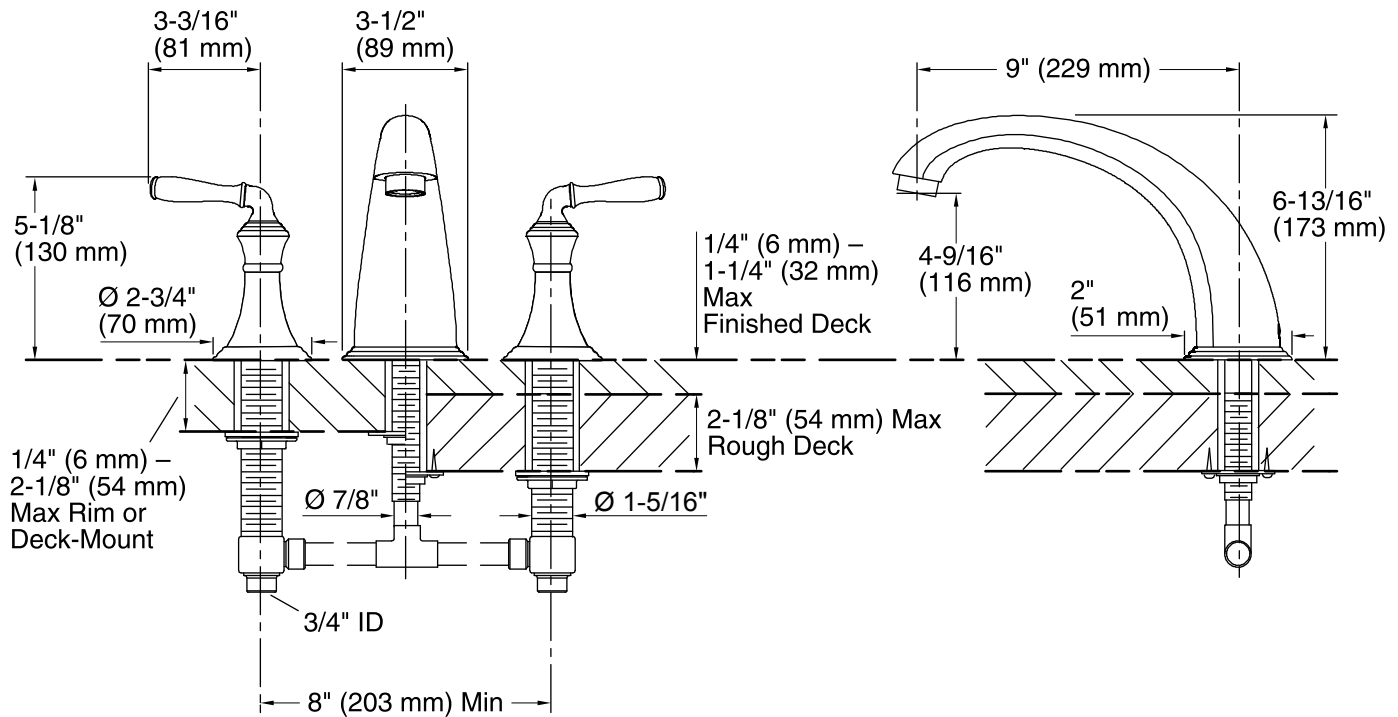

Rim or Deck-Mount Installation

Rough + Finished Deck-Mount Installation

Technical Information

All product dimensions are nominal.

Notes

Install this product according to the installation guide.

ADA compliant when installed to the specific requirements of these regulations.