



COMMERCIAL 24 VOLT FLUE DAMPER SERIES WATER HEATER WITH HONEYWELL INTEGRATED CONTROL SYSTEM

Gas Water Heaters



SERVICE MANUAL

Troubleshooting Guide
and Instructions for Service

(To be performed ONLY by
qualified service providers)

Models Covered by This Manual:

For The Bradford White
“D” Series Models:
D38T155
D75T(125,160,300)
D65T(370,399)
D80T(180,199,250)
D80T(425,505)
D100T(199,250)
D80L(399,450,505)
D100L(199,250,270,300)
D100S(199,250)



As required by the state of California Proposition 65.

Table of Contents

	<u>Page</u>	<u>Service Procedure</u>
Introduction	4	---
Tools Required for Service	4	---
Sequence of Operation	6	---
Troubleshooting	7	---
Thermostat Circuit Testing	24	D24-I
Pilot Operation Testing	27	D24-II
Main Burner Operation Testing	30	D24-III
Main Burner & Pilot Removal & Inspection	32	D24-IV
Flue Baffle Removal & Inspection	35	D24-V
Anode Removal & Inspection	36	D24-VI
Generic Parts List	38	---
Glossary of Terms	41	---
Notes	41	---

FEATURES OF HONEYWELL INTEGRATED CONTROLS SYSTEM

- Attractive digital water heater display on control panel for setting and displaying the temperature setpoint. Pressing temperature up and down buttons changes the temperature setpoint. Temperature format may be displayed in degrees F or degrees C.
- Single control board with plug in wiring controls temperature, ignition, and flue damper operation.
- Reduced number of parts for servicing and wiring.
- Plug in wiring reduces chance of miswiring.
- Water heater display will show diagnostic codes in the event the water heater needs servicing. Aids in diagnosing and servicing the water heater.
- Water heater display can show up to 10 previous error codes in the service mode to further aid in servicing the water heater.

It is intended for this manual to be used by qualified service personnel for the primary purpose of troubleshooting analysis and repair of the Bradford White 24 Volt Flue Damper Series Water Heater. Understanding the sequence of operation section of this manual will contribute greatly to troubleshooting this product.

Troubleshooting begins by noting the error code, if any, on the water heater control display and finding the section in this service manual for diagnosing the problem for this error code. This step by step procedure beginning on page 5 will direct the service provider to a series of test procedures to determine root cause of failure.

Contact Technical support immediately if diagnosis is not determined using the methods described in this service manual.

Tools Required for Service

Manometer:	Two types available, a liquid "U" tube type or a digital (magna-helic) type. This device is used to measure gas and/or air pressures and vacuum.
Multi-Meter:	A digital type is strongly recommended. This device is used to measure electrical values. The meter you select must have the capability to measure volts AC, volts DC, Amps, micro-amps and ohms.
Thermometer:	Used to measure water temperature. An accurate thermometer is recommended.
Water Pressure Gage:	Used to measure water supply pressure. Also used to determine tank pressure by adapting to the drain valve of the heater.
Jumper Leads:	A length of wire (12" min.) with alligator clip at both ends.
Various Hand Tools:	Pipe wrench, channel locks, open end wrench set, 12" crescent wrench, Allen wrench set, torx bit set, screw drivers (common & phillips), long reach (12") magnetic tip phillips head screw driver #2 tip, ¼" nut driver, pliers (common & needle nose), socket set including a 1-1/16 deep well socket, wire cutters, wire strippers, wire crimpers, torpedo level, small shop vac, step ladder, and flashlight.

Specifications

Power Supply	Dedicated 120 VAC, 60 Hz., 15 A
Current Draw	Less than 5 Amps.
Gas Supply Connection	1" NPT connection to gas valve for 370,000 Btu/hr. and over for natural gas, ¾" NPT for rest. Schedule 40 black iron pipe recommended.
Approved Gas Type	Natural or Propane. Gas supply must match the gas type listed on the water heater rating label.
Gas Pressure (Nat. & L.P.)	Manifold Pressure: 4.5" w.c. natural gas, 10.0" w.c. L.P. Gas Supply Pressure: At least 1" above manifold pressure with water heater operating, 14" w.c. maximum.
Venting System	Atmospherically Vented, Type B venting system or approved chimney. Follow current National Fuel Gas Code requirements or in Canada, the Natural Gas and Propane Installation Code.
Minimum Clearance for Servicing	24" Front Clearance, 20" Top, 6" Sides.
Maximum Water Supply Pressure	150 PSI.
Thermostat Sensor(s)	Redundant thermister with 11,900 + or - 0.5% ohms resistance at 70 deg. F. Sensor inside well for lower sensor. Some models use an additional upper sensor (w/o well) with same resistance values.
Control Board	Honeywell Integrated Control Board for Temperature Control, Flue Damper, and Ignition Control Functions. Operates on 24 volts AC current from transformer. Some models use single sensor boards, others use two sensors.
Control Display	Honeywell LCD Control Display with Temperature Setpoint, Format, and Error Code Display in User Mode, Diagnostic Functions in Service Mode. Communicates with Control Board.
Transformer	120 VAC Primary, 24 VAC Secondary, 40 VA.
Pilot	Intermittent Pilot with Spark Electrode and Flame Sensor monitored by Control Board.
Flue Damper	24 VAC, 60 Hz., 80 Ma.

- 1 Thermostat calls for heat.
The control board sends 24 volts from damper terminal #2 on the control plug to the flue damper.
- 2 Flue damper begins to rotate open. Once the flue damper is fully open, the damper end switch closes and 24 volts is allowed to continue through damper to damper pin terminal #5.
- 3 Trial for ignition (three 90 second ignition trials, with 65 second pauses between trials).

Control Board simultaneously sends:

1. 24 volts from control pin terminal #8, to “MV/PV” terminal of gas valve (common terminal).
2. 24 volts from control pin terminal #2, to “PV” terminal of gas valve to establish gas flow at pilot.
3. Low current high voltage from “spark” terminal, to generate spark at the pilot and ignite pilot gas flow.
4. Pilot flame proving signal (measured in micro-amps). from the “sense” terminal, to prove pilot flame.

- 4 Once pilot flame is proven, sparking will stop.
- 5 Once sparking stops, 24 volts is sent from control pin terminal #5 on control board, to “MV” terminal on gas valve to establish main burner gas flow. Main burners ignite from the pilot flame.

The control board constantly monitors pilot flame through the flame sensor rod. If pilot flame is lost, pilot and main burners are shut down. After a 65 second inter-purge period, the control will attempt to re-light the pilot beginning at sequence 3 above.

- 7 Main burner fires until the thermostat is satisfied. The control board interrupts 24 volts through the damper and the gas valve circuit. Pilot and main burners are turned off.
- 8 Flue damper rotates to the closed position.

LOCKOUT CONDITION

Control board will go into “Soft Lockout” if the pilot cannot be lit after 3 ignition trials. The water heater display indicates a lockout condition by showing an error code number (62 or 63) with “Service Needed” in the display window. Refer to error codes in the diagnostic section of this Service Manual. In a “Soft Lockout” condition, the control will wait for 60 minutes and then make 3 more attempts to light the pilot and establish the main burners.

Soft lockout reset is accomplished by depressing the lower right button under “Reset” for 3 seconds.

If the water heater should reach 200 degrees F, then the high limit control will shut off the burners and the water heater will go into a “Hard Lockout”. Error code 65 will be shown in the water heater display. The control can only be reset in the “service mode”, which is detailed in the next section of this Service Manual.

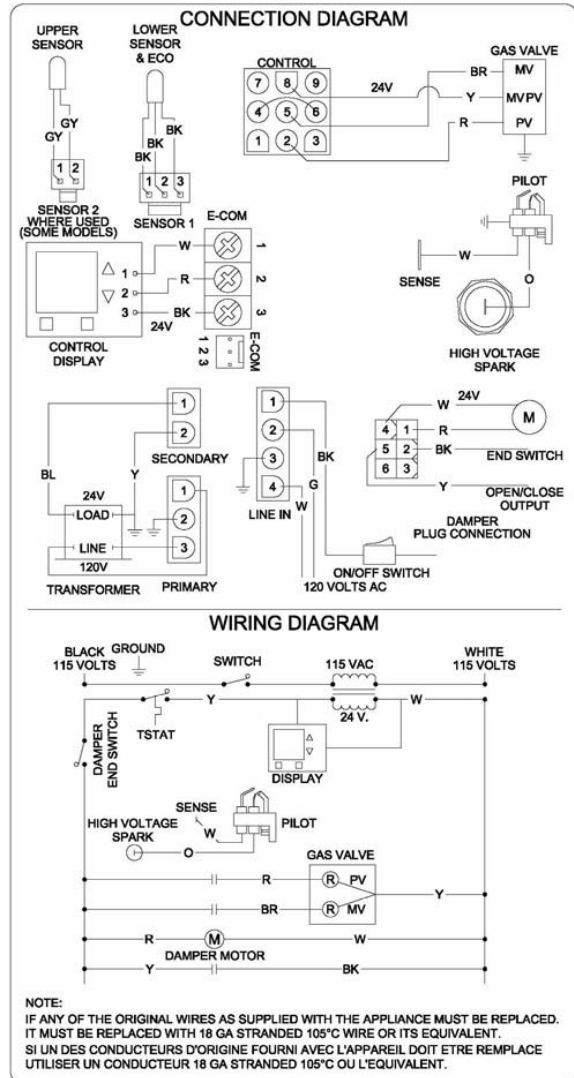

WIRING DIAGRAM

CAUTION
Use Caution Not to Damage Connectors when making Voltage Measurements or Jumping Terminals

Water Heater Fault: Water heater does not operate
Display Error Code: Water heater display does not operate - blank display

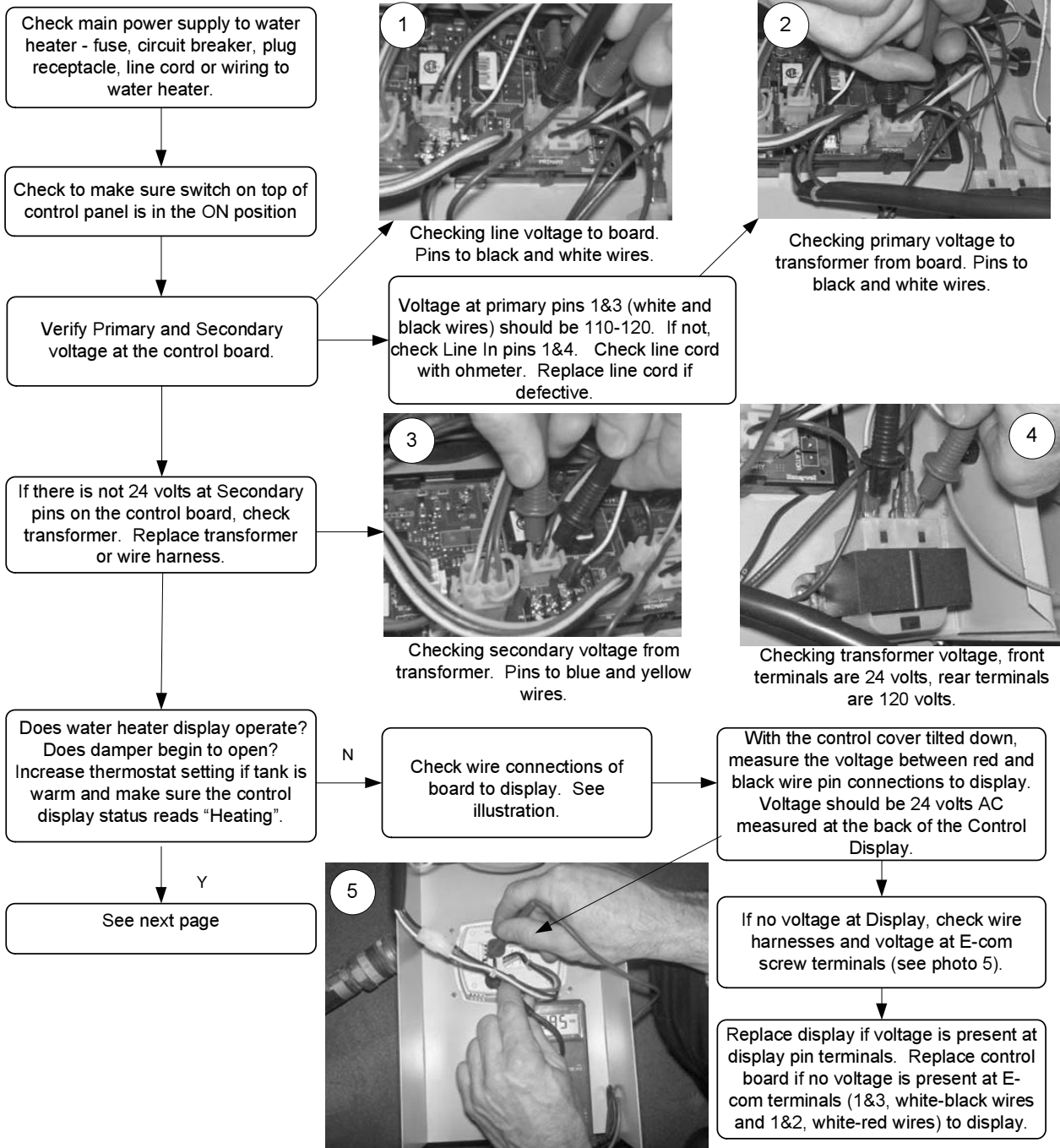

CAUTION
Use Caution Not to Damage Connectors when making Voltage Measurements or Jumping Terminals

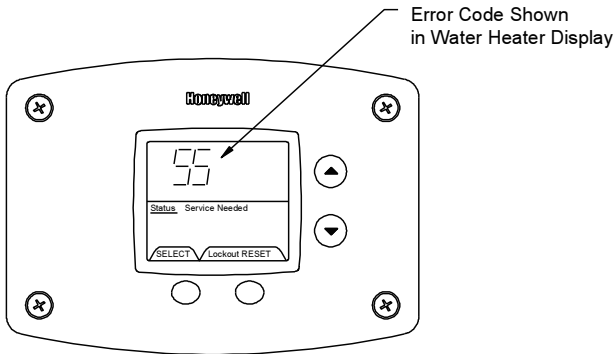
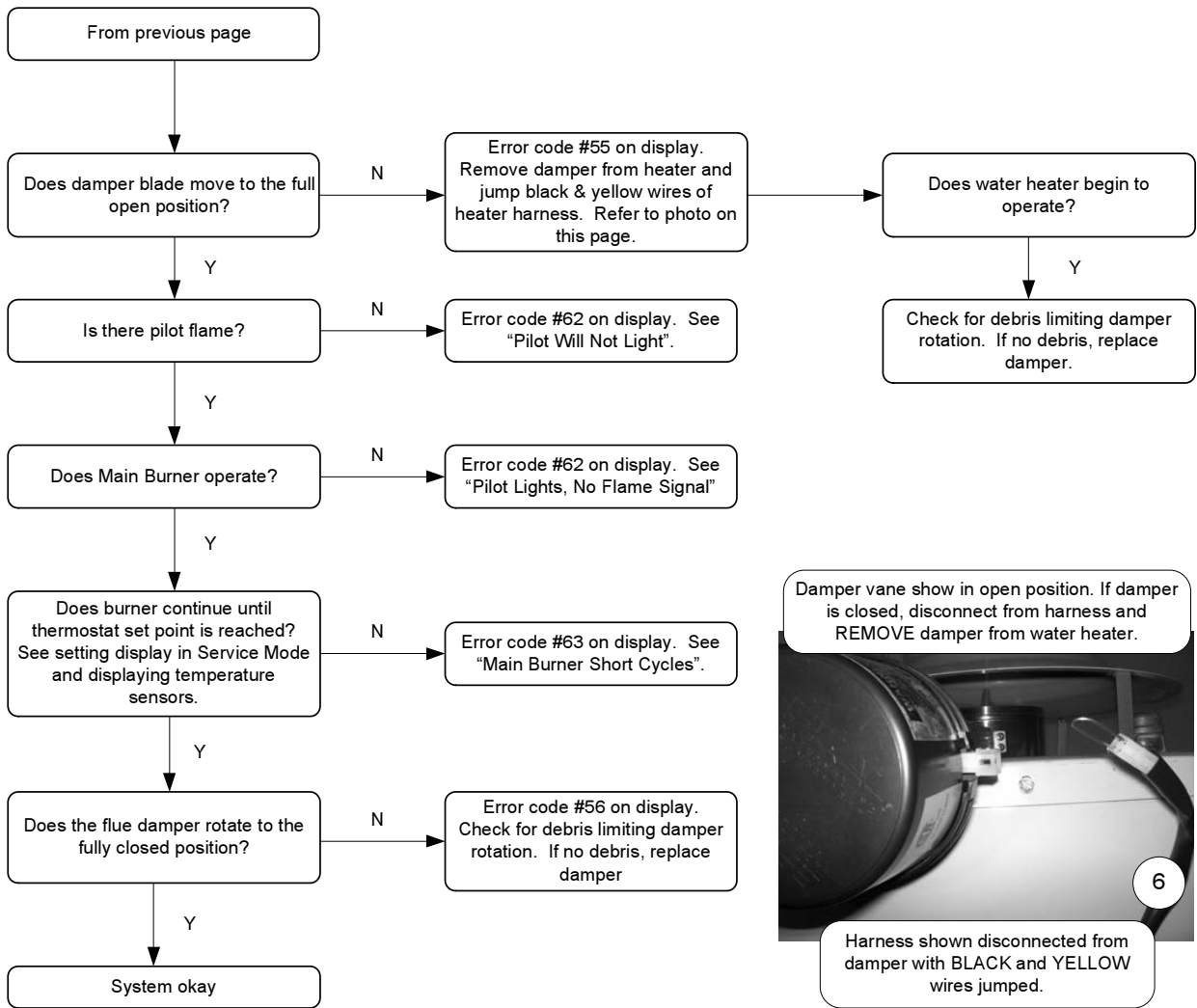

Example of error code shown on control display.

ACCESSING SERVICE MODE ON THE WATER HEATER DISPLAY (FOR SERVICE PERSONNEL ONLY)

The display has a “service mode” for changing the maximum setpoint and accessing information in aiding servicing of the water heater. This procedure is for service and installation personnel only. To enter the Service Mode, follow the steps illustrated below:

Step 1: Press “Select” and “Temperature Up” buttons together and hold for 3 seconds until “Max Setpoint” is shown in the display.

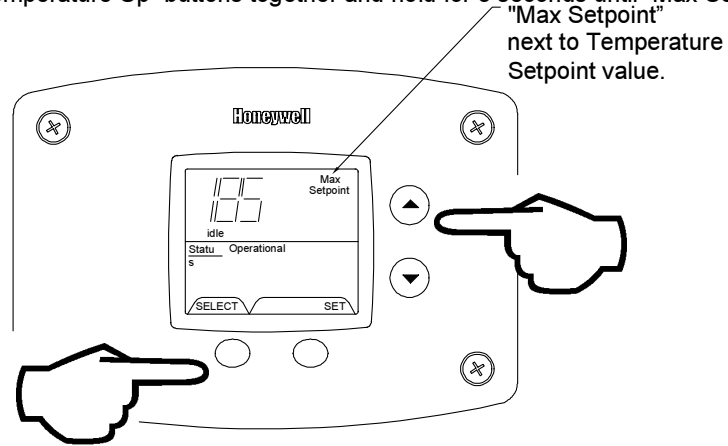

Step 2: Pressing “Select” button will change display to next mode

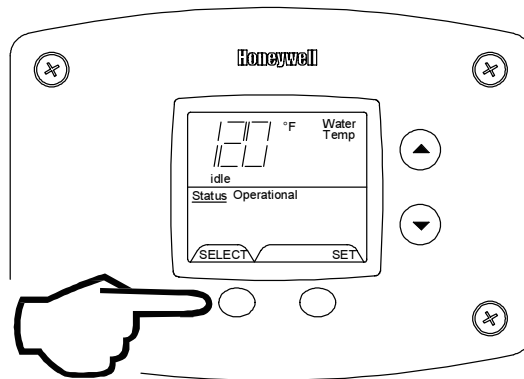

The following is the sequence of modes available in “Service Mode” by pressing the “Select” button:

Error Code Number (Display/Reset). This is only shown if there is an operating error in the “User Mode”.

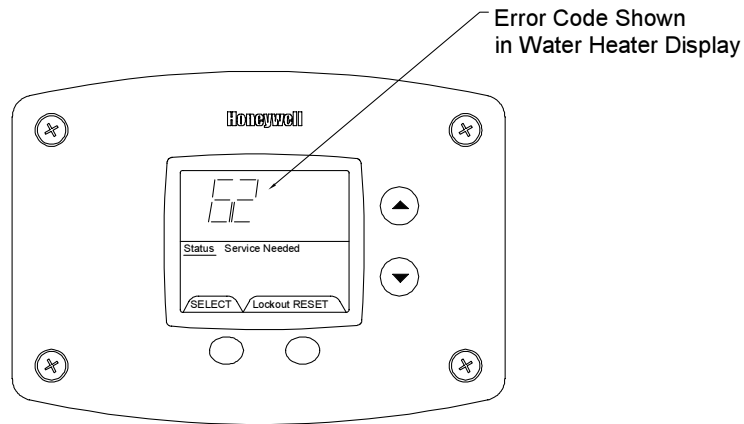

1. Max Setpoint (Display/Change)

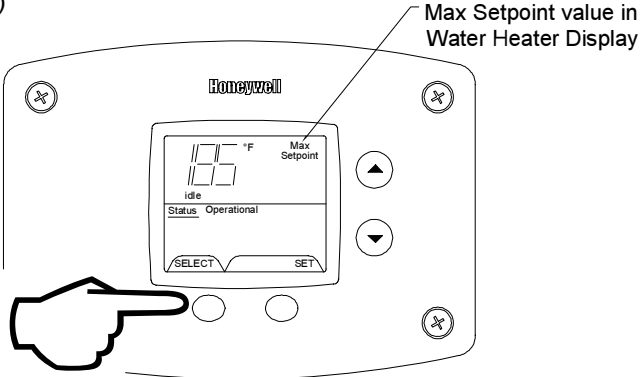

2a. Water Temperature Average (Displays average if there are two sensors - sensor temperature displayed if single sensor is used).

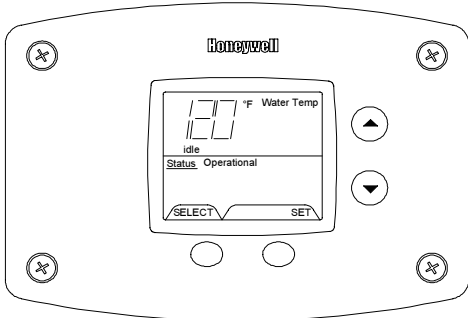

2b. Water Temperature - Upper Sensor (Displays if there is an upper sensor - some models)

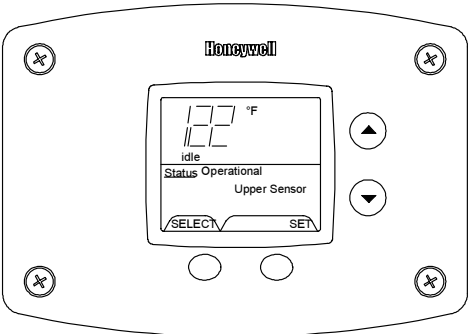

2c. Water Temperature - Lower Sensor (Displays if there are two sensors)

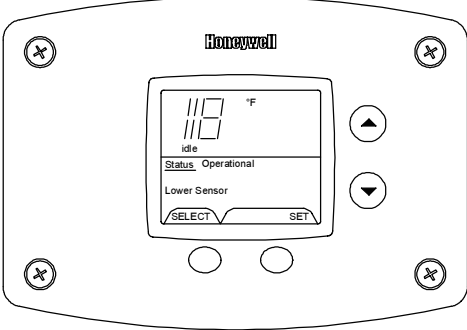

3. Flame Current of Pilot Flame Sensor (Displays only in the Heating Cycle)

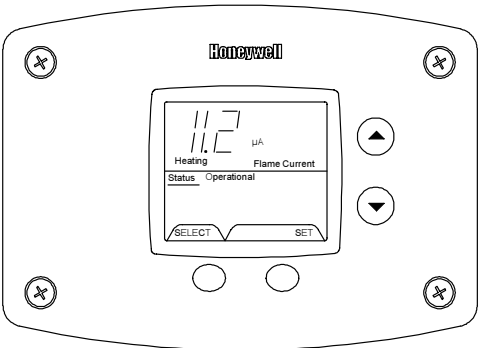

4. Setpoint (Display/Change)

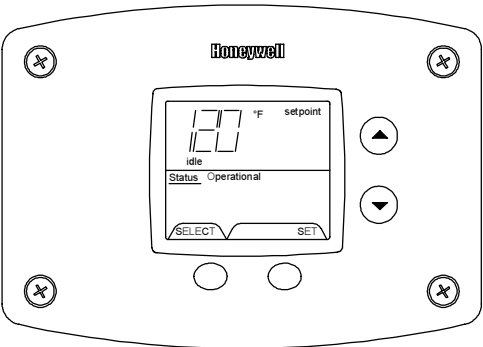

5. °F/°C (Display/Change)

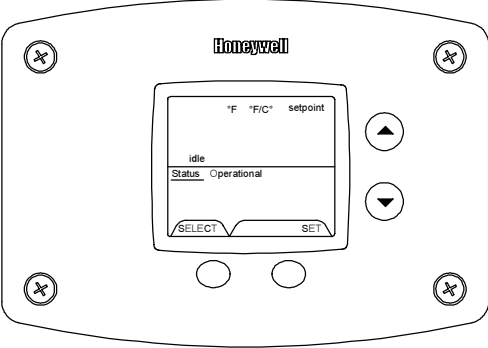

6. Differential (Display only - shows the differential of the thermostat)

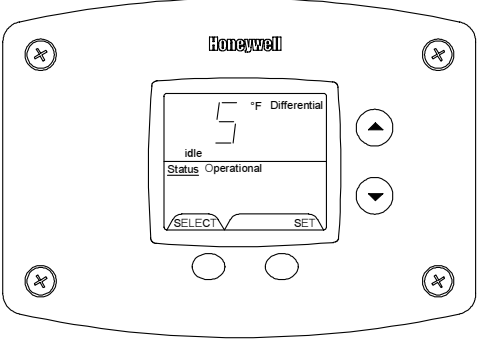

7. Software Version (Display only)

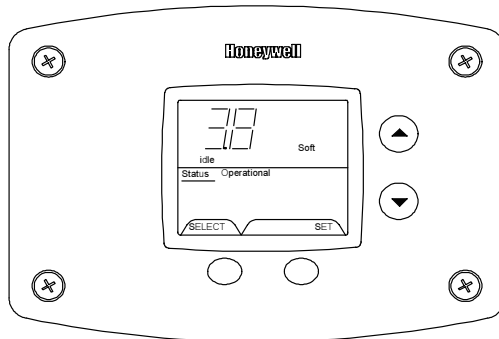

8. Error Code History (Displays if there are present error codes or up to 10 previous error codes). Water Heater Display will show a "--" if there are no error codes.

▲ WARNING
Setting the water temperature to the maximum set point can result in scalding hot water delivered to the faucets. It is highly recommended that the maximum setpoint be adjusted to the lowest temperature possible for the needs of the installation. Make sure the water heater control display is not in a public area that can result in the temperature settings being improperly adjusted.

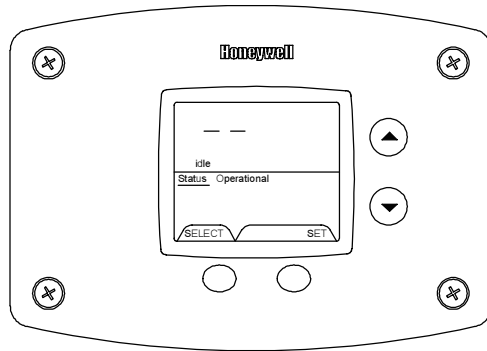

To change the Maximum Setpoint Limit (Max Setpoint) for the temperature setpoint:

Step 1: In service mode press the "Select" button until "Max Setpoint" is displayed.

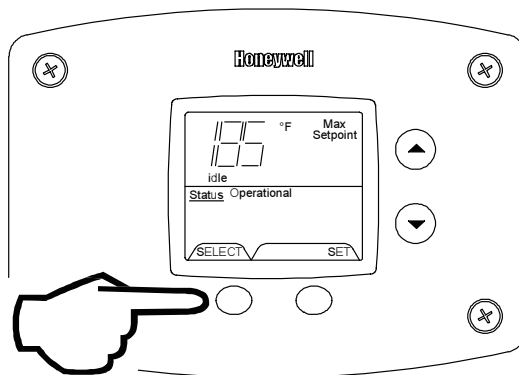

Step 2: Press "Set" button to enter setting mode. "Max Setpoint" will flash to indicate setting mode.

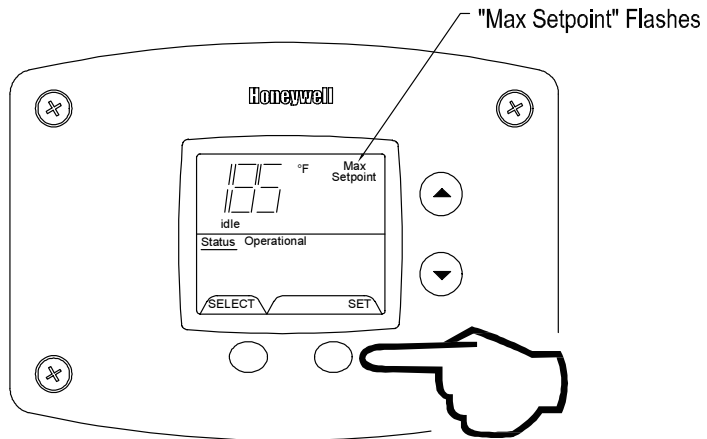

Step 3: Press the "UP" or "DOWN" buttons to change the maximum setpoint value. This will limit the maximum setpoint the user can select. Note: The maximum setpoint is approximately 180°F.

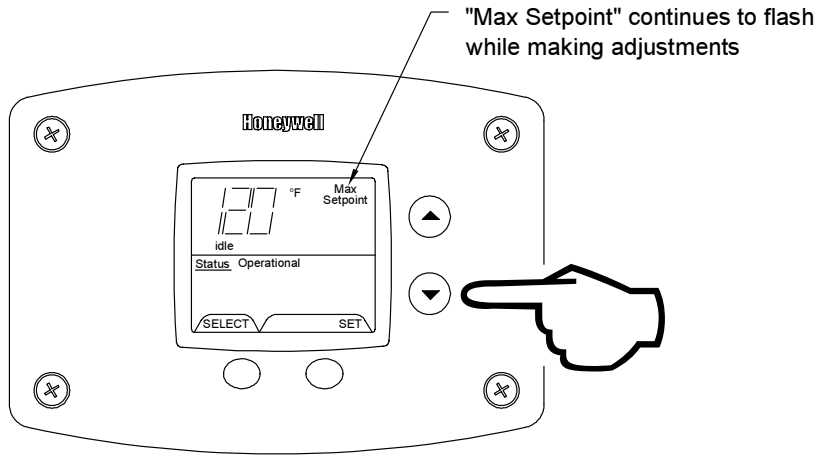

Step 4: Press "Set" button to confirm new "Max Setpoint" value and stop setting mode.

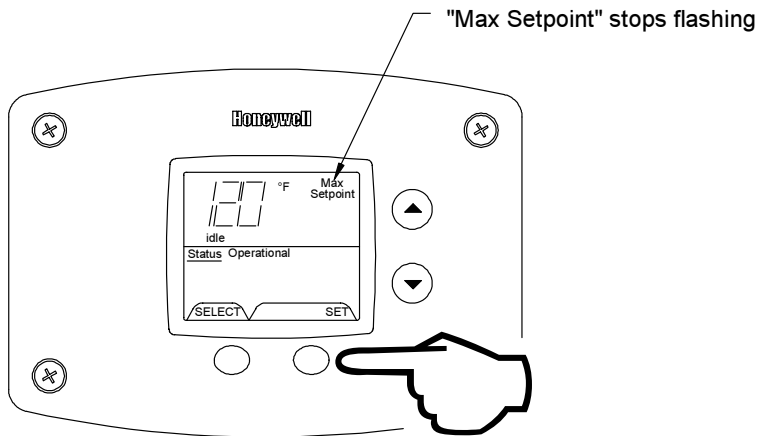

Step 5: 30 Seconds after the last button press, the Water Heater Display will go back to "User Mode". It will read "Max Setpoint" without showing a temperature value if the temperature setpoint is at the maximum setting. The Water Heater Display can be set back to the "User Mode" immediately by pressing both the "Temperature Up" and "Select" buttons together for 3 seconds.

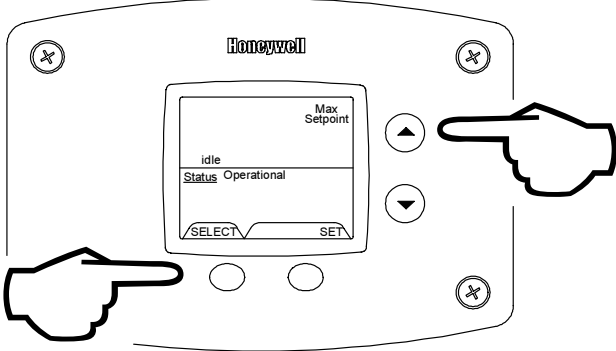

Exiting Service Mode

Display of Water Temperature:

Step 1: In Service Mode, Press the "Select" button until "Water Temp" is displayed in the upper right section of the water heater display. For water heaters using two temperature sensors in the tank, this will be the average reading between the two sensors. For water heaters using a single sensor, this is the reading for the sensor.

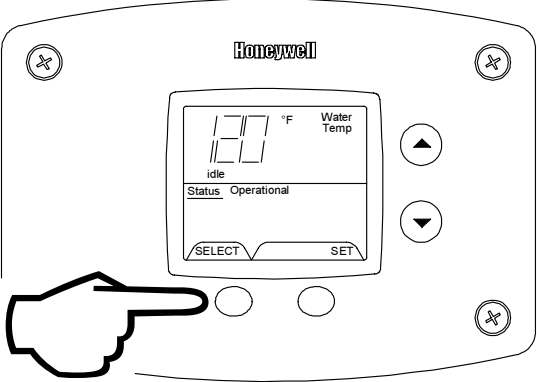

Step 2: For water heaters using two temperature sensors, pressing the "Select" button again displays the Upper Sensor temperature reading. "Upper Sensor" will be displayed in the lower right side of the status window of the water heater display.

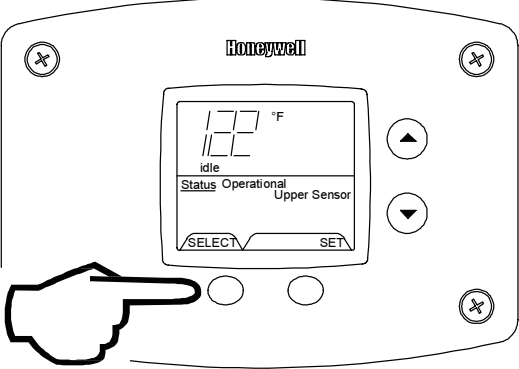

Step 3: For water heaters using two temperature sensors, pressing the “Select” button again displays the Lower Sensor temperature reading. “Lower Sensor” will be displayed in the lower left side of the status window of the water heater display.

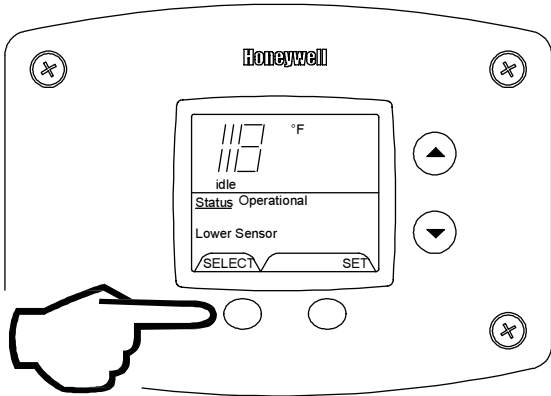

To Display Flame Sense Current of the Pilot Flame Sensor:

The pilot flame sense current is available only when the burners are in operation. Step 1: Make sure the status displays “Heating” or draw enough hot water to start the burners. Step 2: Enter the “Service Mode” described previously. Step 3: Press the “Select” button until a number value is displayed with “Flame Current” to the right of the number. The value displayed is in microamps (μ A).

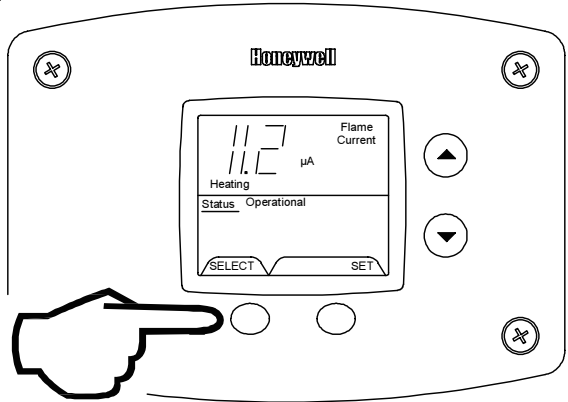

To Display and Change Temperature Setpoint:

Step 1: In “Service Mode” press the “Select” button until “Setpoint” is shown in the water heater display

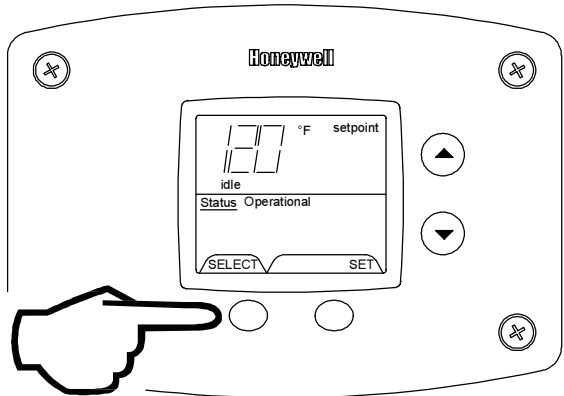

Step 2: Press the "Set" button to enter the setting mode. "Setpoint" will flash in the water heater display.

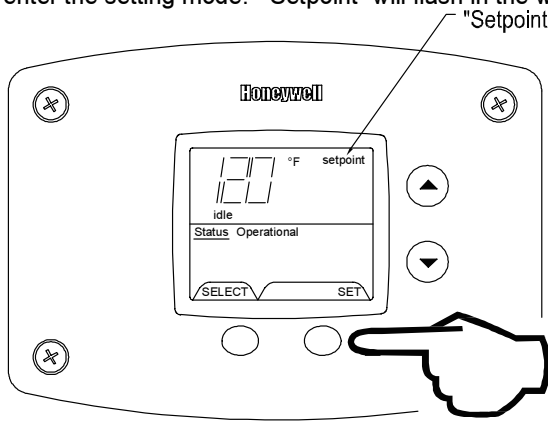

Step 3: To raise the temperature setpoint, press the "Temperature Up" button until the desired temperature is shown on the water heater display.

NOTICE
The maximum temperature that can be set in the Water Heater Display is limited to the "Max Setpoint" described previously. To change the "Max Setpoint", refer to the procedure "To Change the Maximum Setpoint Limit..." described previously under "Accessing the Service Mode on the Water Heater Display".

WARNING
Setting the water temperature to the maximum set point can result in scalding hot water delivered to the faucets. It is highly recommended that the maximum setpoint be adjusted to the lowest temperature possible for the needs of the installation. Make sure the water heater control display is not in a public area that can result in the temperature settings being improperly adjusted.

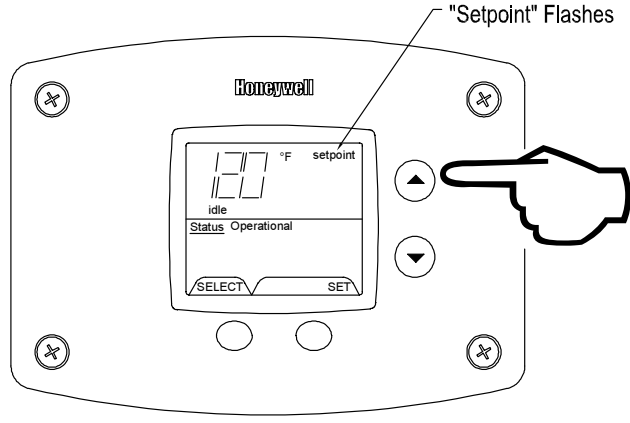

Step 4: To lower the temperature setpoint, press the "Temperature Down" button until the desired temperature is shown on the water heater display.

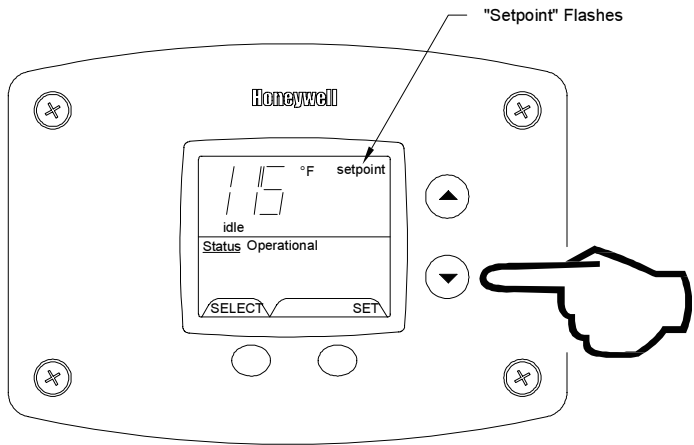

Step 5: When the desired setpoint is reached on the water heater display, press the "Set" button to confirm the new setpoint. "Setpoint" stops flashing in the water heater display.

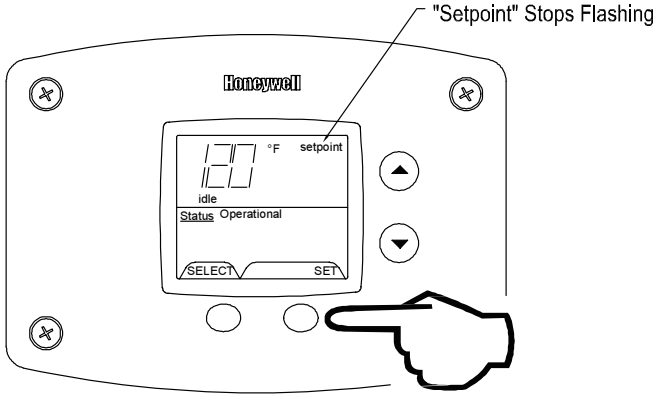

To Display and Change Temperature Format (°F/°C):

To Change Temperature Format in Display from °F to °C or °C to °F:

Step 1: While in "Service Mode", press "Select" button until "°F/°C" is shown in the upper right portion of the water heater display.

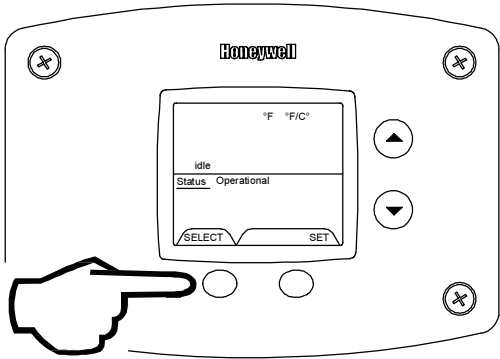

Step 2: Press "Set" button to change temperature format. "°F/°C" symbol will flash in the water heater display.

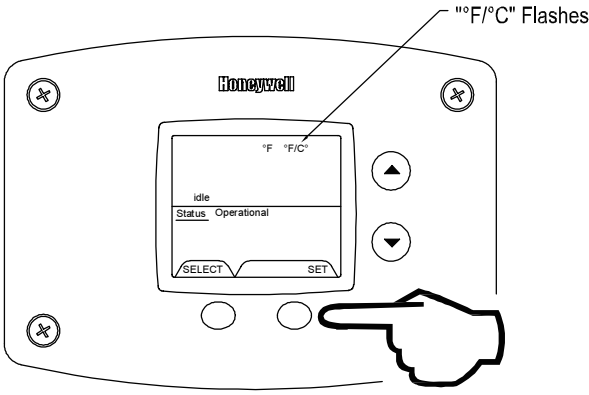

Step 3a: Press "Temperature Up" button to change temperature format to °C

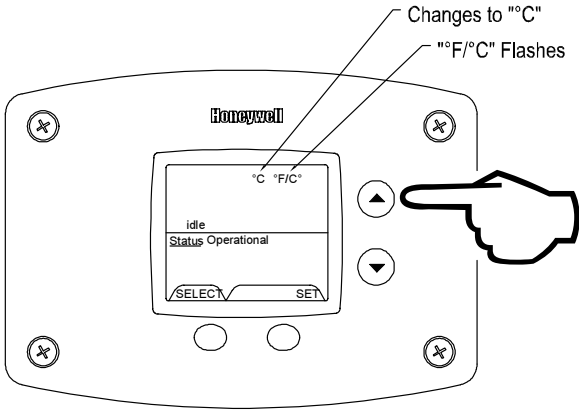

Step 3b: Press "Temperature Down" button to change temperature format to °F

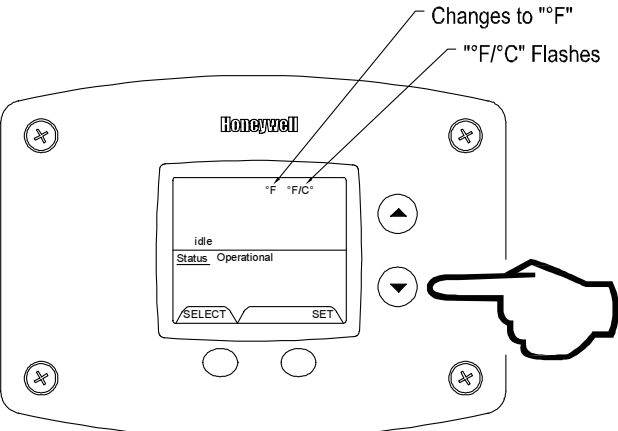

Step 4: Press "Set" button to confirm °F or °C format. °F/°C will stop flashing

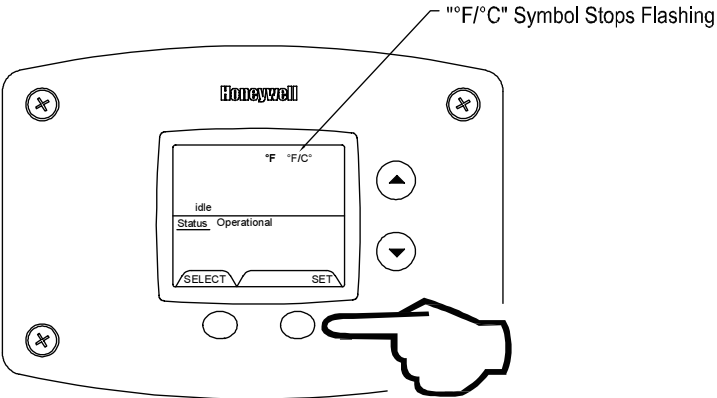

Step 5: Pressing "Select" button will return display to setpoint in format selected (°F or °C) immediately

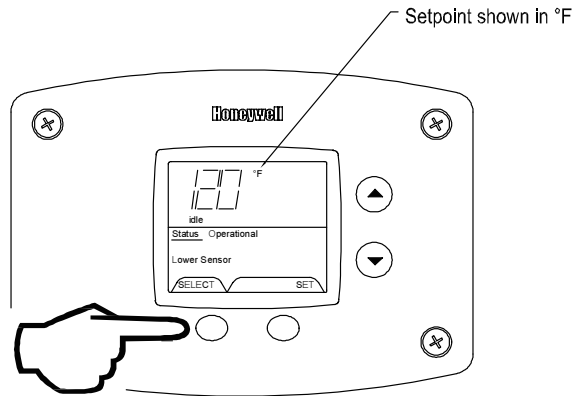

Error Codes and Error History Display:

If there is an operating problem with the water heater, an error code number will appear on the water heater display with "Service Needed" to the right of the "Status" indicator. The error code label is located under the water heater display. The following section in this Service Manual explains the error codes with corrective actions to repair the water heater.

Example of Error Code in the Display

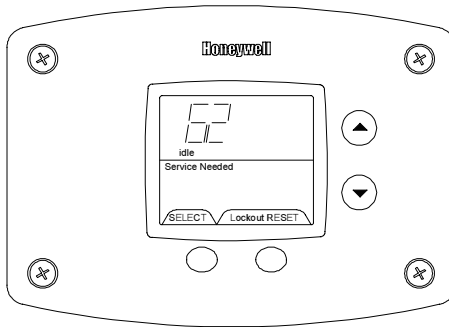

Error Code History:

In "Service Mode" pressing the "Select" button after the "Software Version" (item 8 in the previously described sequence of service modes) will show an error code history, if there have been any previous operating problems with the water heater. If the display shows --, there is not a current error code. The Water Heater Display will provide up to 10 previous error codes. The oldest error code will be stored in code index #1 and the most recent in code index #10.

To view previous error codes:

Step 1:

In "Service Mode" press the "Select" button until the next display after the "Software Version". If there are no current error codes, the display will show -- .

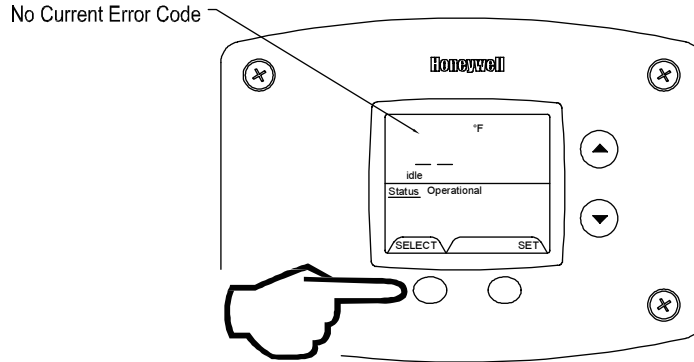

Step 2:

Press the "Temperature Down" button to select the error code index, starting with the most recent error code "10".

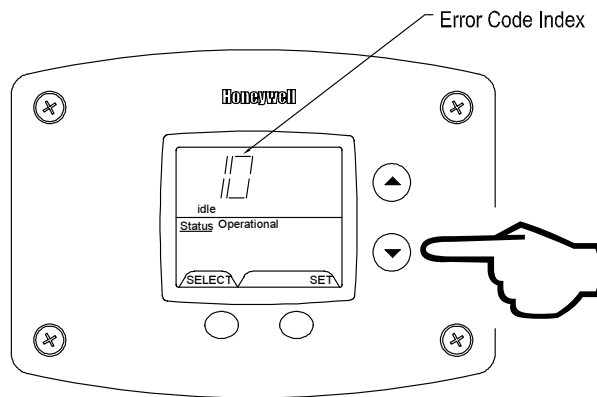

Step 3:

Press the "Select" button to view the error code for "code 10". If there is a number displayed, note what the number is. The label next to the water heater display will identify the code number. If no number is displayed with only a "--" in the water heater display, then there has not been an error code for error code index 10.

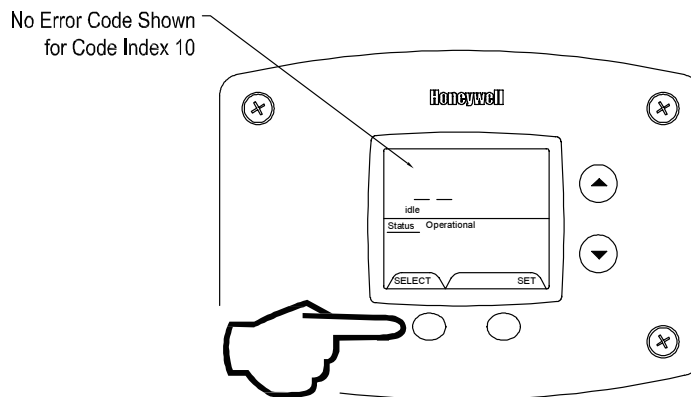

Step 4:
Press the “Temperature Down” button to change to the previous code index, code #9.

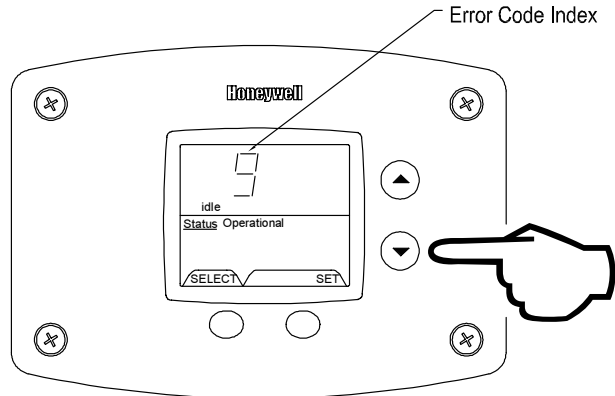

Step 5:
Press the “Select” button for code index #9 to view if there are any code numbers.

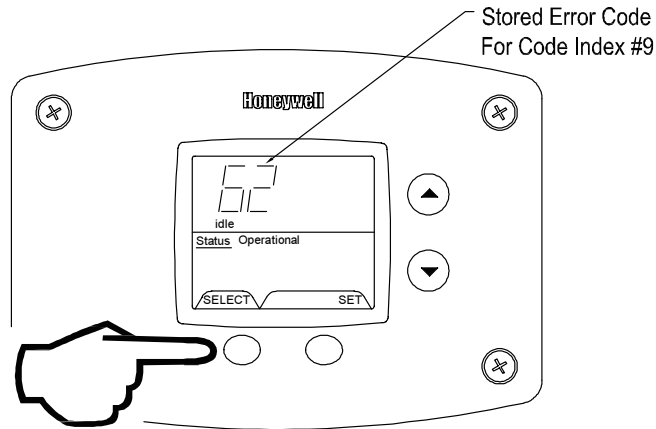

Step 6:
Continue pressing the “Temperature Down” button to change to the next error code index and press “Select” to view the error code number, if any, for that index number. Continue on to index #1, the oldest error code index. The water heater display will store up to 10 error codes with the oldest code starting in code index #1 with the most recent code in code index #10.

Step 7: 10 seconds after the last button press, the Water Heater Display will revert back to the current error code display. To exit Service Mode, either wait 30 seconds or press Temperature Up button and Select Button for 3 seconds.

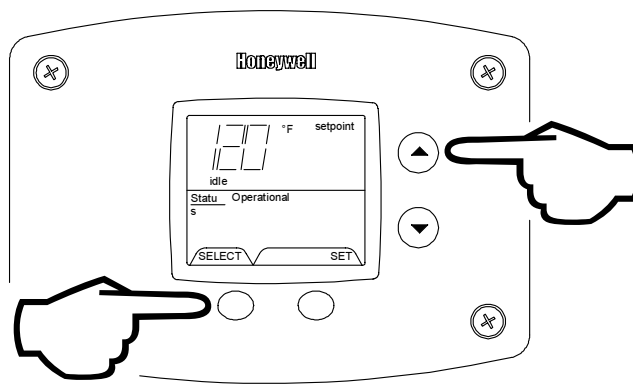

Exiting Service Mode

ERROR CODE DEFINITIONS

If the water heater has an operating problem, there will be a number in the water heater display with "Service Needed" shown below the error code number. Note the error code and the definition in the chart below. This label appears on the control box under the water heater display. The following sections will provide instructions for servicing each error code.

HONEYWELL INTEGRATED CONTROL ERROR CODE DISPLAY FOR 24 VOLT DAMPER MODELS	
ERROR CODE	DEFINITION
4	LOW FLAME SENSE CURRENT
55	DAMPER END SWITCH FAILED TO CLOSE (STUCK OPEN)
56	DAMPER END SWITCH FAILED TO OPEN (STUCK CLOSED)
6	FLAME SENSED OUT OF NORMAL SEQUENCE (BEFORE OPENING GAS VALVE OR AFTER CLOSING GAS VALVE)
23	FLAME DETECTED BEFORE IGNITION
24	FLAME DETECTED AFTER A HEATING CYCLE COMPLETES
31	UPPER SENSOR READINGS FAULTY
32	LOWER SENSOR READINGS FAULTY
57	FLAME ROD SHORTED TO GROUND
58	AC LINE FREQUENCY ERROR - SIGNAL TOO NOISY OR FREQUENCY INCORRECT
59	LINE VOLTAGE TOO LOW OR HIGH
61	DC OUTPUT VOLTAGE UNSTABLE
62	MAXIMUM NUMBER OF RETRIES DETECTED
63	MAXIMUM NUMBER OF IGNITION RECYCLES DETECTED
64	ELECTRONICS FAILURE
65	HIGH WATER TEMPERATURE (OVER 200°F)

IF ANY OF THE ABOVE CODES APPEAR ON THE CONTROL DISPLAY, CONTACT YOUR PLUMBER OR QUALIFIED SERVICE AGENT FOR SERVICE OF THIS WATER HEATER.

238-47617-00A

⚠ WARNING

The following procedure is for service and installation personnel only. Resetting lockout conditions without correcting the malfunction can result in a hazardous condition.

If an error code is displayed (except for #4, low flame sense current), the water heater will be in a “lockout condition” with the water heater display showing the error code number and “Service Needed” in the status section of the display window. Error codes 62 (maximum number of retries detected) and 63 (maximum number if ignition recycles detected) are “Soft Lockouts” in which the control can be reset in the “User Mode” by pressing the lower right button under “Lockout Reset” shown in the lower right portion of the display. The control will also go through 3 attempts to relight the burners every hour in the soft lockout condition.

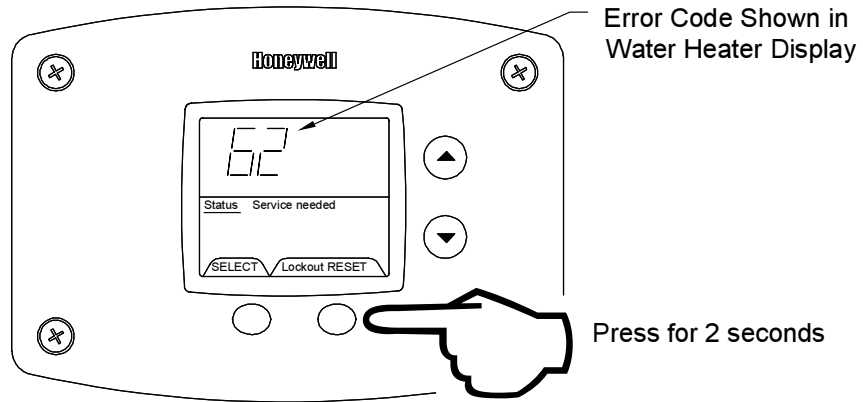

All other error codes will put the water heater into a “Hard Lockout” condition, in which the water heater will not operate and cannot be reset in the “User Mode”. To reset a hard lockout, first enter the “Service Mode” described earlier by pressing both the “Temperature Up” and “Select Buttons” at the same time for 3 seconds. Then press the lower right button under “Lockout Reset” in the water heater display and hold for 3 seconds.

Resetting Error Codes in Hard Lockout Condition

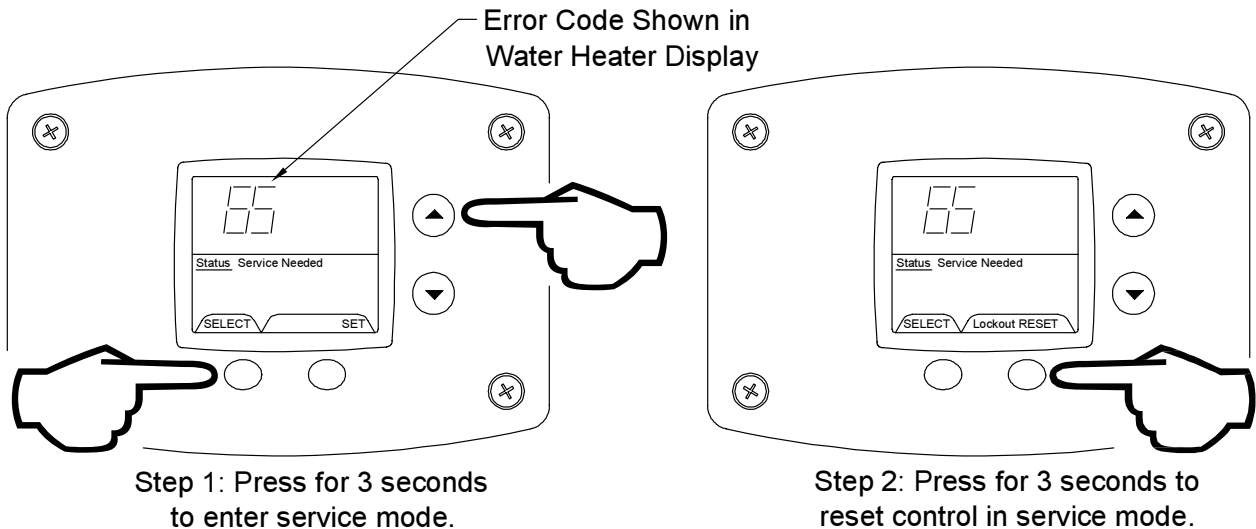



DANGER
120 volt exposure. To avoid personal injury, use caution while performing this procedure.



CAUTION
Be Careful When Making Voltage Measurements or Jumping Terminals Not to Damage or Deform Connectors or Connector Pins.

This procedure assumes the flue damper is in working order. Be sure damper opens under its own power when the thermostat circuit is by-passed. Damper must be open or removed during this test. Do not force damper open using your hands or tools.

Condition: Water Heater Not Operating
Display shows error code "31" (Upper Sensor Readings Faulty) or error code "32" (Lower Sensor Readings Faulty)

Unplug or disconnect electrical power to the water heater

Check continuity of wire harness to affected sensor. Measurement of ohmmeter should be close to 0 ohms. Replace wire harness if high resistance is measured (over 0.5 ohms) Check wires for intermittent connections, shorts, frayed insulation. Replace if necessary (see photo 8)

If wire harness checks out O.K. check resistance of sensor. Refer to section on Sensor Resistance Testing. If sensor resistance is not near the values shown in the table, then replace upper or lower sensor as indicated by error code number.

Turn power on to water heater.
Run water heater through heating cycle and verify proper operation. Sensor temperature can be viewed when burner shuts off (see section on viewing the display in "Service Mode".

Condition: Water Heater Not Operating
Display shows error code "65"
High Water Temperature (over 200 deg. F)

WARNING!
Do not reset the display from the hard lockout state without correcting the cause of the overheating condition.

Turn power "OFF".
Draw water to cool tank below 120 deg. F

Check lower sensor. Is the sensor fully inserted into the well? Sensor is held in place with a clip fastened to the well (see photo 9)
Check lower sensor wire making sure it is not damaged or has breaks in the wire insulation. Check upper harness wires to upper sensor, if used (some models).



7 Measuring upper sensor resistance through wire harness (disconnected at control board).



8 Checking continuity of upper sensor wire harness.



9 Removing lower sensor from well. Held in place by a clip fastened to well shoulder.

N

If sensor clip is damaged replace clip. Replace lower sensor if damaged.

See next page

Y

Check Sensor Resistance (see "Sensor Resistance Testing" section & photo 7)



WARNING!
Do not operate water heater without verifying that the overheating condition has been corrected.

Condition: Water Heater Not Operating
Display shows error code "65"
High Water Temperature (over 200 deg. F)
Continued

Once cause of overheating condition has been diagnosed and corrected, the control may be reset

- Reconnect and switch on power to the water heater.
- Enter service mode on the water heater display (see illustration)
- Press button under "Lockout Reset" and hold for 3 seconds.
- Set thermostat to the desired setting.
- Water heater should start.
- Monitor temperatures for one complete heating cycle making sure the maximum tank temperature remains well below 200 deg. F

This water heater is equipped with a manual reset type gas shutoff device designed to shut off the gas to the burners if excessive water temperature occurs. To reset the control, first press the "temperature up" and "select" buttons on the water heater display for 3 seconds to enter service mode. Then press the lower right button under "RESET" in the display for 3 seconds.

Error code 65 indicates high limit lockout condition

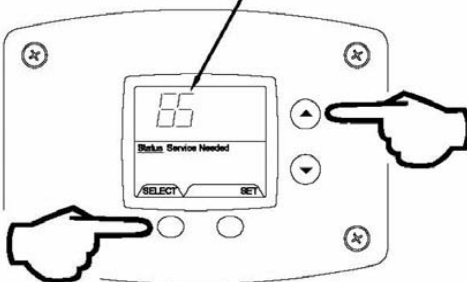

Step 1: Press for 3 seconds to enter service mode.

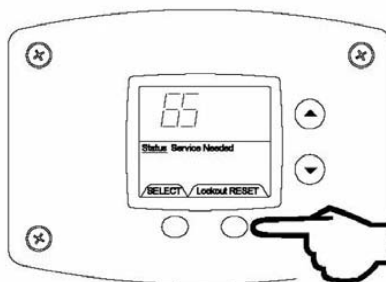

Step 2: Press for 3 seconds to reset control.

Conditions: Upper or Lower Sensor Reading Faulty, High Water Temperature, or suspect thermostat is not accurate.

SERVICE PROCEDURE D24-I Thermostat Circuit Testing

Sensor Resistance Testing

Upper Sensor

1. Determine resistance value of upper sensor. Test across grey wires.
2. Draw quart of water off **T&P valve**. Using a thermometer, determine water temperature.
3. Use table below to verify correct resistance per water temperature measured.

Lower Sensor:

1. Determine resistance value of lower sensor. Test across center wire (common) to each outside wire. Resistance of both thermistors in the lower sensor should be close to each other. If the resistance values for both thermistors are not close to each other, replace the lower sensor. The dual thermistors are used to provide high limit protection in case the thermostat circuit fails to shut off the water heater.
2. Draw quart of water off **Drain Valve**. Using a thermometer, determine water temperature.
3. Use table below to verify correct resistance per water temperature measured.

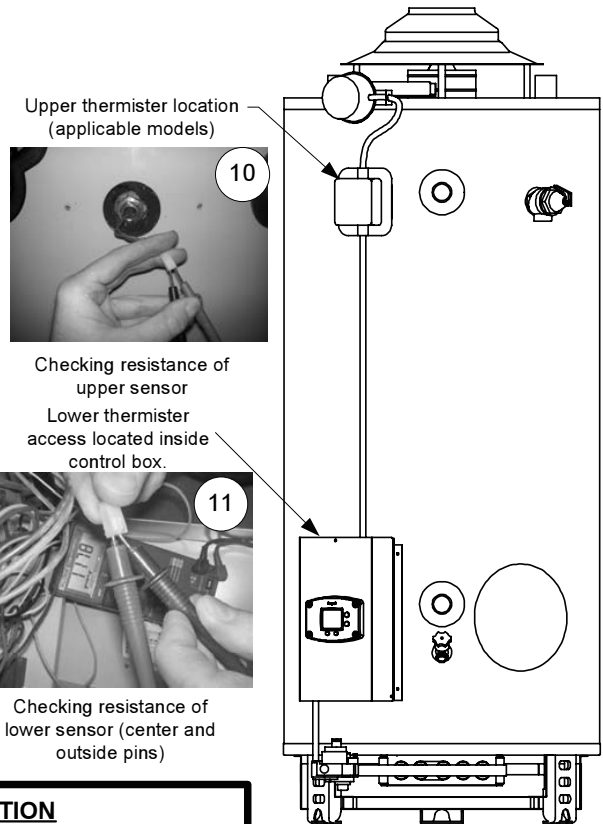
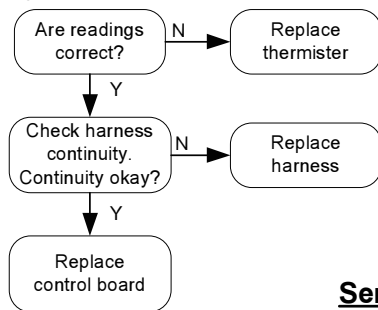

CAUTION
Be Careful When Making Resistance Measurements Not to Damage or Deform Connectors or Connector Pins.

Sensor Resistance at Various Temperatures

Example: If water temperature is 84°F, then the resistance through the sensor would be 8449 (see shaded area).

NOTE: Sensor resistance increases as the temperature falls.

		In Degrees F									
°F	0	1	2	3	4	5	6	7	8	9	
40	26109	25400	24712	24045	23399	22771	22163	21573	21000	20445	
50	19906	19383	18876	18383	17905	17440	16990	16553	16128	15715	
60	15314	14925	14548	14180	13823	13477	13140	12812	12494	12185	
70	11884	11592	11308	11032	10763	10502	10248	1000	9760	9526	
80	9299	9078	8862	8653	8449	8250	8057	7869	7685	7507	
90	7333	7165	7000	6839	6683	6531	6383	6238	6098	5961	
100	5827	5697	5570	5446	5326	5208	5094	4982	4873	4767	
110	4663	4562	4464	4368	4274	4183	4094	4006	3922	3839	
120	3758	3679	3602	3527	3453	3382	3312	3244	3177	3112	
130	3048	2986	2925	2866	2808	2752	2697	2643	2590	2538	
140	2488	2439	2391	2344	2298	2253	2209	2166	2124	2083	
150	2043	2004	1966	1928	1891	1856	1820	1786	1753	1720	
160	1688	1656	1625	1595	1566	1537	1509	1481	1454	1427	
170	1402	1376	1351	1327	1303	1280	1257	1235	1213	1191	
180	1170	1150	1129	1110	1090	1071	1053	1035	1017	999	
190	982	965	949	933	917	901	886	871	857	842	
200	828	814	801	788	775	762	749	737	725	713	

⚠ DANGER
120 volt exposure. To avoid personal injury, use caution while performing this procedure.

⚠ CAUTION
Be Careful When Making Voltage Measurements or Jumping Terminals Not to Damage or Deform Connectors or Connector Pins.

Condition:
Pilot will not light or stay lit,
Error codes 62, or 63 shown on Water
Heater Display

Reset control by pressing the lower right button under "reset" on the display for 3 seconds. Does control board start ignition sequence and start sparking (sparking noise at pilot or at board)

N → Replace control board

Y → Is there spark at the pilot?

N → Check for:
Loose or damaged ignition wire
Grounded pilot electrode
Damaged pilot.

Y → Is there 22-27 volts AC output across terminal pins 8 & 2 on "Control" plug of Control Board? Carefully insert meter probe in wire plug to check pin terminals. Make sure control is in the trial for ignition sequence (see Sequence of Operation). (see photo 13)

N → Replace control board.

Y → Is there 22-27 volts AC input across wire leads "MV/PV" & "PV" (yellow & red wires) at Gas Valve? (see photo 12)

Y → Loosen pilot tubing connection at the gas valve and soap test. Is there pilot gas flow out of the gas valve? See pilot illustration for pilot inspection. (Wires must be connected to gas valve during this test).

Y → Check for clogged or kinked pilot tube, clogged pilot orifice. Clean or replace as needed. (see "Pilot Burner Inspection")

N → Check wire harness for damage or loose connections. Repair or replace as needed.

N → Tighten pilot tube connection at the gas valve. Check incoming gas pressure to water heater. if okay, replace gas valve

Turn on power to the water heater and verify proper operation

Check across "MV/PV" & "PV" Wire leads to gas valve

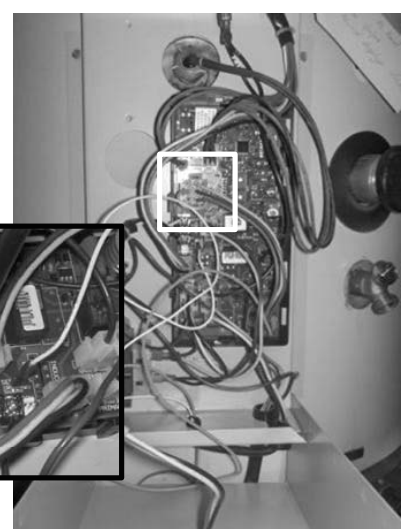
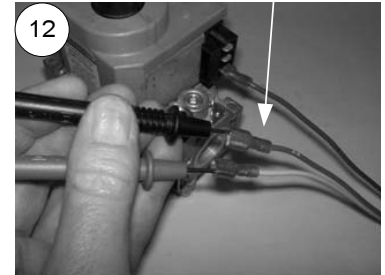

13
Checking for 24 volts output to pilot valve (yellow and red wire pin terminals) on control board "control" plug.

Condition:
Error code 57: Flame Rod Shorted to Ground

Disconnect power. Shut off gas supply to water heater. Slide out burner assembly (see section on "removing pilot and main burner assembly").

Check to see if pilot shield is touching pilot flame sensor or flame sensor touching pilot hood. Bend shield to prevent interference or replace pilot shield.

Check pilot flame sense wire for broken insulation. Replace pilot if defective

Reinstall pilot and burner assembly. Reconnect gas line union, turn on gas.

Check for Gas Leaks

Reconnect power and verify proper ignitions.

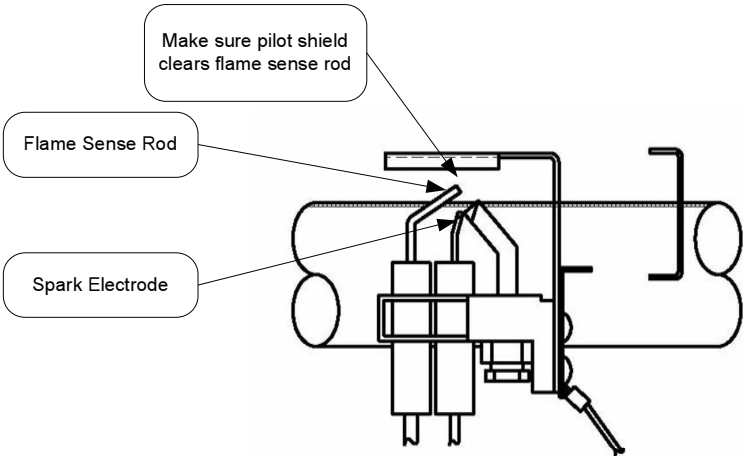

⚠ DANGER
120 volt exposure. To avoid personal injury, use caution while performing this procedure.

⚠ CAUTION
Be Careful When Making Voltage Measurements or Jumping Terminals Not to Damage or Deform Connectors or Connector Pins.

Condition:
Pilot lights, no or low flame signal. Control Display shows "4" or "62" for Error Codes (Service Needed). Control continues to spark until system "Lock Out". Main burner will not light.

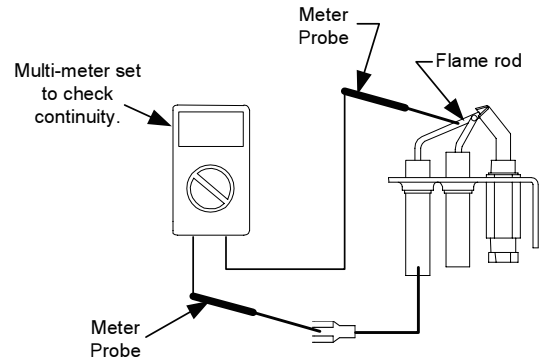
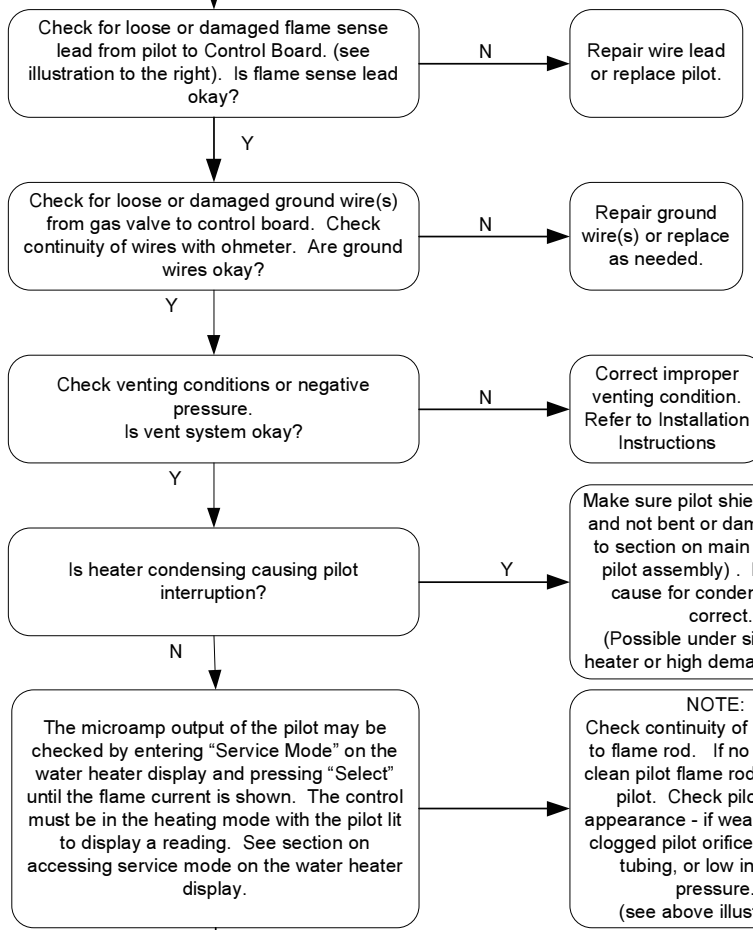

Checking pilot flame sensor wire and flame rod for continuity.

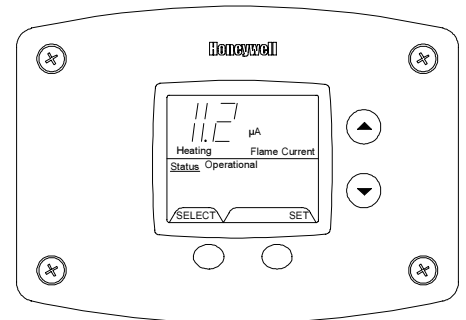

Pilot flame sensor microamp output shown in display using service mode. Pilot must be lit to get reading.

Micro-amp readings

0.000 Micro Amp = Replace control board or pilot if wire is damaged.

1.0 micro amp or less = Clean pilot flame rod or replace pilot.

<p style="text-align: center;">⚠ DANGER</p> <p>120 volt exposure. To avoid personal injury, use caution while performing this procedure.</p>	<p style="text-align: center;">⚠ CAUTION</p> <p>Be Careful When Making Voltage Measurements or Jumping Terminals Not to Damage or Deform Connectors or Connector Pins.</p>
--	--

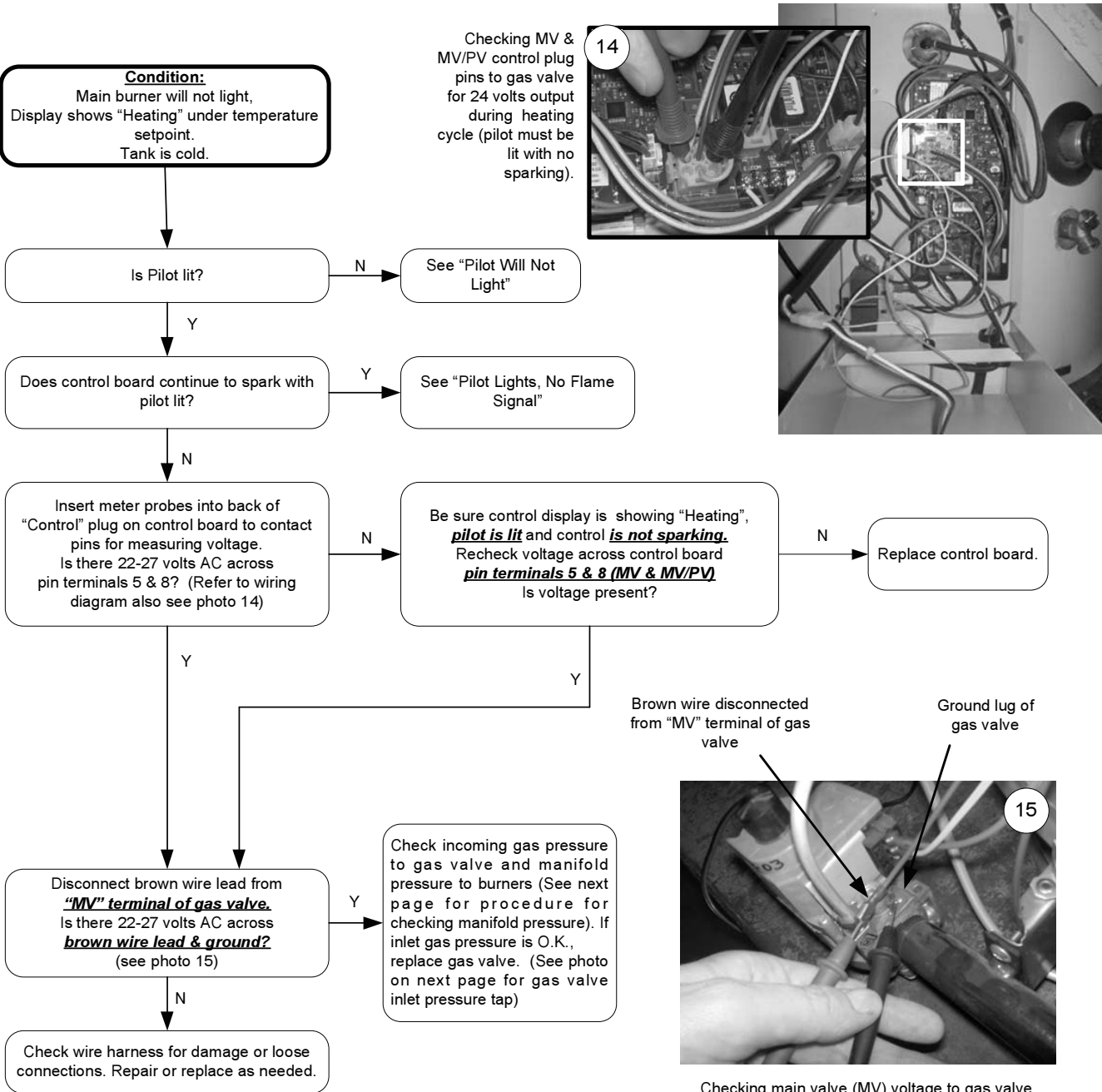

▲ DANGER
120 volt exposure. To avoid personal injury, use caution while performing this procedure.

▲ CAUTION
Be Careful When Making Voltage Measurements or Jumping Terminals Not to Damage or Deform Connectors or Connector Pins.

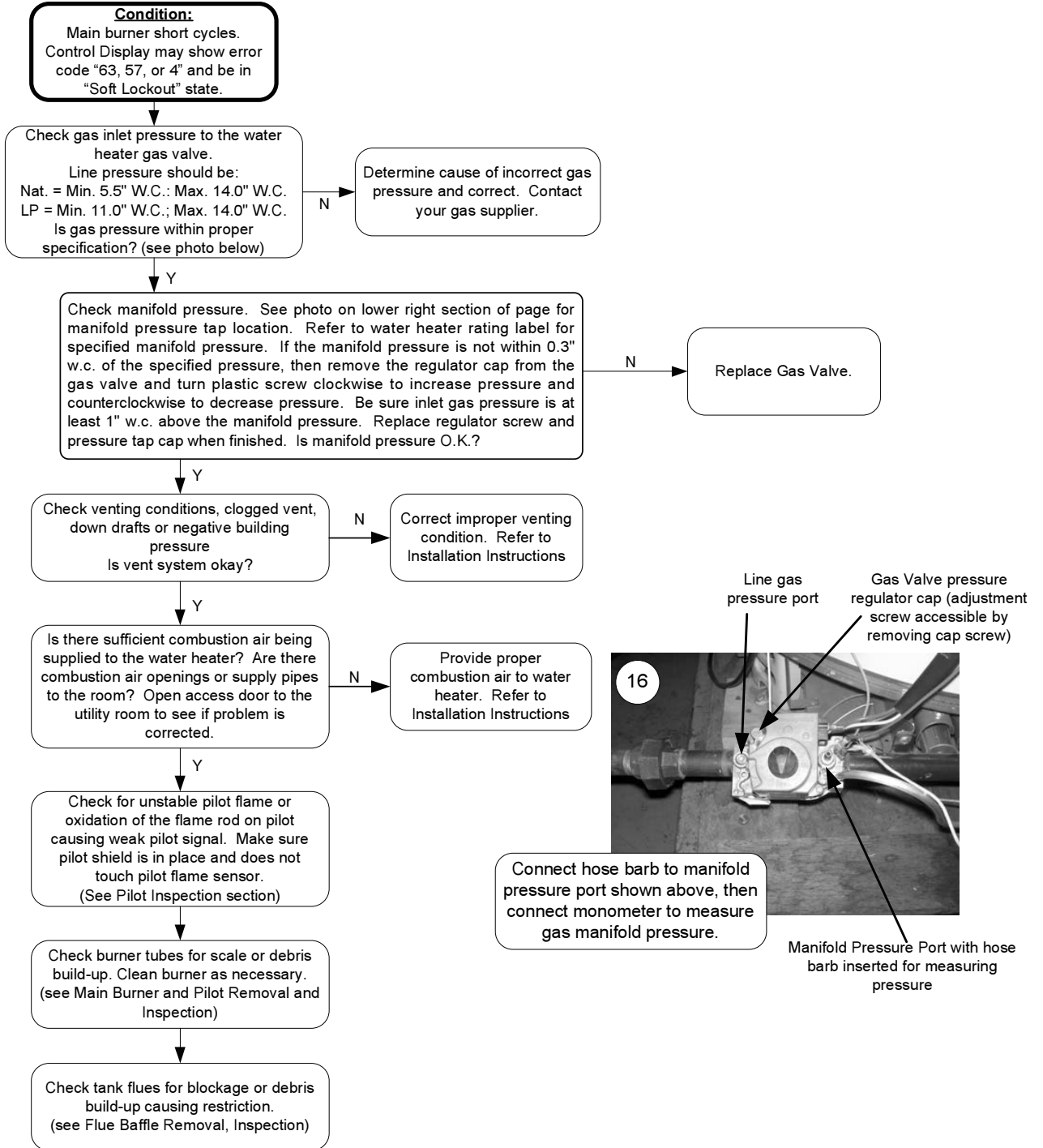

⚠ WARNING
Heater components may be HOT when performing the following steps in this procedure.
Take necessary precaution to prevent personal injury.

Main Burner Removal

Step 1. Disconnect (un-plug) water heater from electrical supply.

Step 2. Turn "OFF" gas supply to water heater.

Step 3. Rotate gas valve control knob to the "OFF" position (see photo 17).

Step 4. Disconnect Gas supply line from the gas valve (see photo 17).

Step 5. Disconnect wire leads from gas valve (see photo 17).

Step 6. Disconnect white flame sense wire & orange ignition wire from Control Board (see photo 18).

Step 7. Remove the two burner rack mounting screws (see photo 17).

Step 8. Slide complete burner rack out from heater (see photo 19).

Step 9. To install burner, reverse above procedure.

Step 10. Check for gas leaks and verify proper operation.

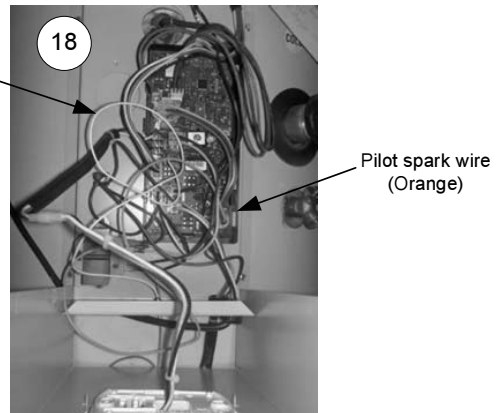
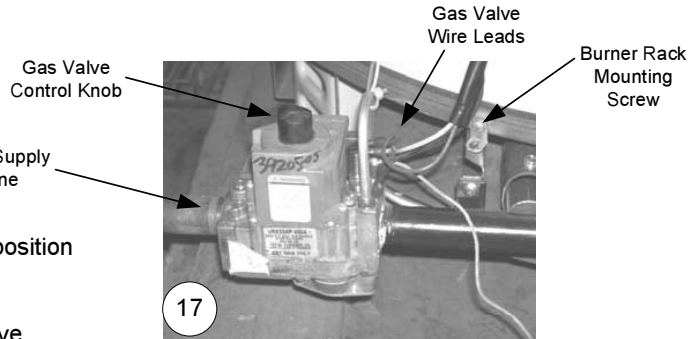

Main Burner Inspection

Step 1. Burner tubes should be free of any flue scale or other debris. Clean burner tubes using a stiff brush and/or shop vac. Burner ports should have uniform openings. Replacement is recommended for burners where port area is deteriorated or other unintended openings are present.

Step 2. Insure pilot shield is in place (see photo 20).

Step 3. Inspect pilot position to insure smooth burner ignition from pilot flame. Pilot should be mounted using the two mounting screws through the burner support bracket resulting in a level pilot position.

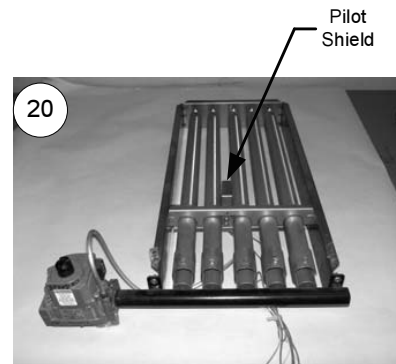

Pilot Burner Removal

- Step 1. With burner rack removed from heater, disconnect pilot tube connection from gas valve
- Step 2. Remove the two pilot burner mounting screws securing the pilot and pilot shield in place.
- Step 3. Remove pilot shield and pilot from burner rack.
- Step 4. To install pilot burner and pilot shield, reverse above procedure. Be sure to reconnect green ground wire.

Pilot Shield

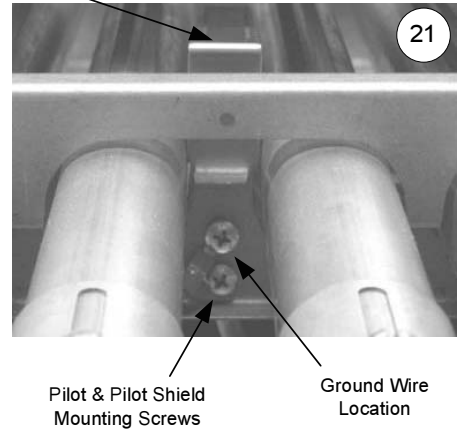

Pilot Burner Inspection

- Step 1. Inspect pilot for the following:
 - a) Broken or cracked ceramic insulators. If found, pilot must be replaced.
 - b) Damaged electrode or flame sense wire. If found, pilot must be replaced.
 - c) Oxidation build-up on flame rod. Clean flame rod or replace pilot as necessary.
- Step 2. Inspect pilot orifice:
 - a) Remove 7/16" ferrule nut from bottom of pilot.
 - b) Remove pilot tube and orifice from pilot.
 - c) Inspect pilot tube for blockage. Clean or replace as necessary.
 - d) Inspect pilot orifice for blockage. Clean or replace as necessary.

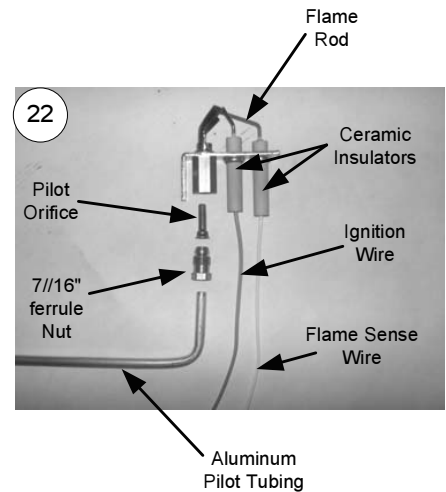

⚠ DANGER
120 volt exposure. To avoid personal injury,
unplug while performing this procedure.

Control board replacement

Step 1: Disconnect Power

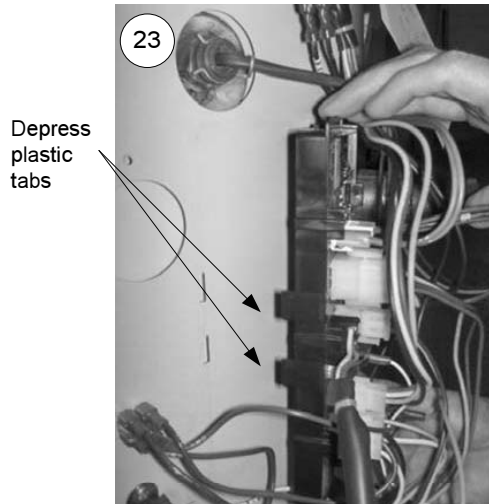

Step 2: Unplug wire connections from board.

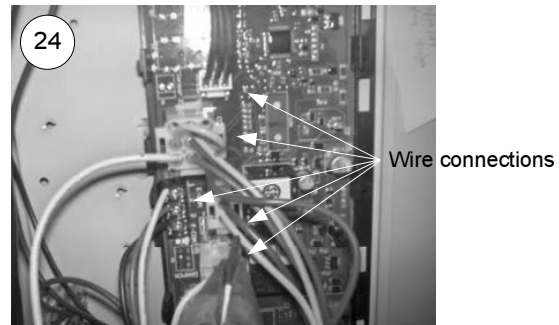

Step 3: To remove board, tilt control panel to the right and slide control hook tabs from slots in control panel.

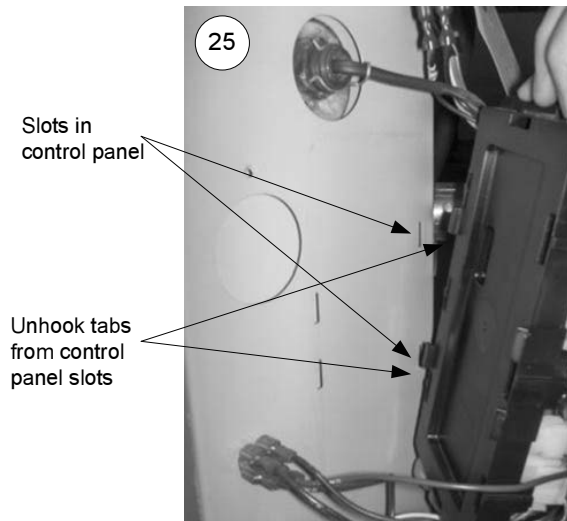

To remove lower sensor

Remove clip, pull sensor out.

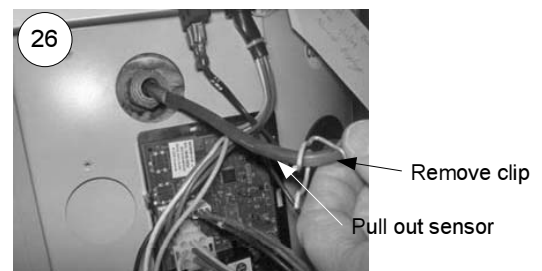

IMPORTANT
When replacing lower sensor, make sure
sensor is fully inserted into the well and
securely held by the clip on the well groove.
(see photo 25)

⚠ WARNING
Heater components may be HOT when performing the following steps in this procedure.
Take necessary precaution to prevent personal injury.

Step 1. Disconnect (unplug) water heater from electrical supply.

Step 2. Disconnect venting from draft diverter and remove draft diverter from top of water heater.

Step 3. Disconnect flue damper from wire harness and remove flue damper from top of water heater (see photo 27).



Step 4. If required, turn "OFF" water supply & disconnect top plumbing connection from top of water heater.

Step 5. Remove screws holding jacket head to top of water heater and remove jacket head from top of water heater. Note, it may be necessary to use a screw driver to pry underneath jacket head (see photo 28).



Step 6. Remove insulation from top of water heater to expose collector cover.

Step 7. Remove screws from side (or top) of collector cover. Note, it may be necessary to chisel away some foam to access screws (see photo 29).



Step 8. Remove collector cover from water heater by using pipe wrench as illustrated in photo 30.

Step 9. Remove flue baffles from water heater. Note, it may be necessary to use pliers to loosen and remove baffles from flue tubes (see photo 31).



Step 10. Visually inspect flue baffles. Flue baffles may show signs of oxidation; this is normal. If the oxidation has deteriorated any portion of the flue baffle, replacement is recommended. If any restrictors are missing, replacement is recommended.

Step 11. Upon completion of inspection or subsequent replacement, reinstall flue baffles into heater.

Step 12. Reinstall collector cover and insulation over collector cover.

Step 13. Reinstall jacket head, flue damper and draft diverter. Reconnect venting.

Step 14. Reconnect plumbing connection to top of water heater & turn on water supply if required.

Step 15. Check for leaks and verify proper operation.

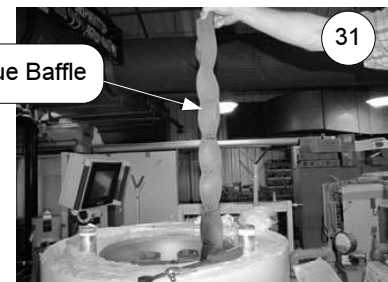

WARNING

Heater components may be **HOT** when performing the following steps in this procedure. Take necessary precaution to prevent personal injury.

- Step 1. Disconnect (unplug) water heater from electrical supply.
- Step 2. Turn "OFF" water supply to water heater.
- Step 3. Open a near by hot water faucet to relieve tank pressure.
- Step 4. Connect hose to drain valve of water heater and route to an open drain. Open drain valve and drain a minimum of 5 gallons of water from the water heater. Close drain valve and disconnect drain hose from water heater.
- Step 5. Disconnect venting from draft diverter and remove draft diverter from top of water heater.
- Step 6. Disconnect flue damper from wire harness and remove flue damper from top of water heater (see photo 32).
- Step 7. If required, turn off water supply and disconnect top plumbing connection from top of water heater.
- Step 8. Remove screws holding jacket head to top of water heater and remove jacket head from top of water heater. Note, it may be necessary to use a screw driver to pry underneath jacket head (see photo 33).
- Step 9. Remove insulation from top of water heater to expose collector cover, remove if necessary. (see next page for approx. anode locations)
- Step 10. Remove screws from side (or top) of collector cover. Note, it may be necessary to chisel away some foam to access screws (see photo 34).
- Step 11. Locate and remove anode rods from top of water heater (1-1/16 hex socket). Note, anodes located outside of the collector (see photo 35) may require foam to be chiseled away to access anode rods. (see next page for approx. anode locations)
- Step 12. Visually inspect anode rod. Anode rod may show signs of depletion; this is normal. If the anode shows signs of depletion (approximately 5/8", see photo 36), replacement is recommended. If any of the steel core of the anode is exposed, replacement is recommended.
- Step 13. Upon completion of inspection or subsequent replacement, reinstall anode rods into water heater.
- Step 14. Check for leaks.
- Step 15. Reinstall collector cover & insulation over collector cover.
- Step 16. Reinstall jacket head, flue damper and draft diverter. Reconnect venting.
- Step 17. Reconnect plumbing connection to top of water heater if required.
- Step 18. Restore water supply and power to water heater.
- Step 19. Verify proper operation.

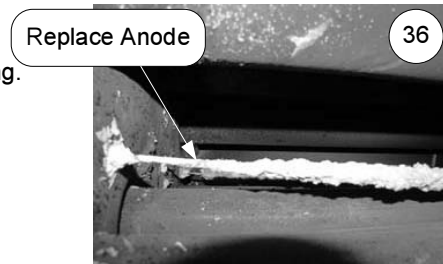
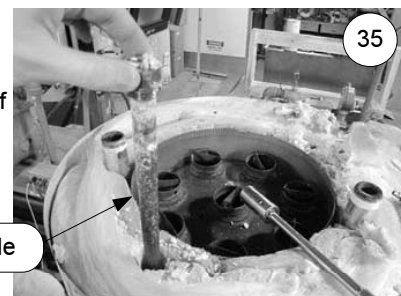
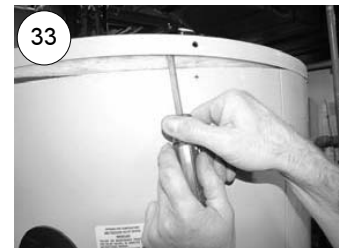

Approximate Anode Rod Locations

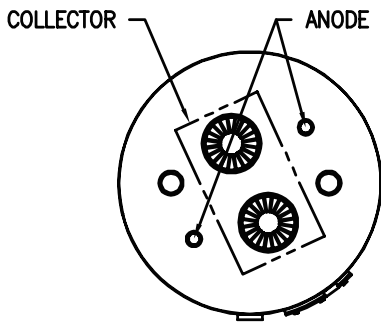

FRONT OF WATER HEATER
D75T(125,160)

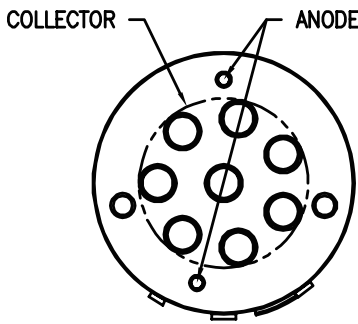

FRONT OF WATER HEATER
D80T(180,199,250)
D100T(199,250)

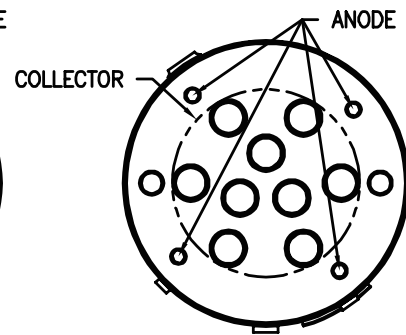

FRONT OF WATER HEATER
D100S(199,250)

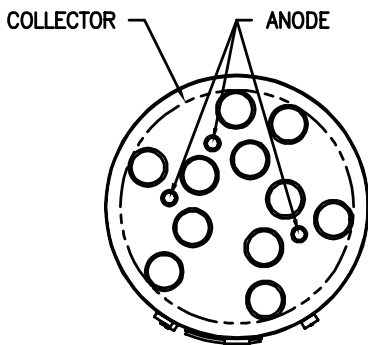

FRONT OF WATER HEATER
D38T155
D75T300

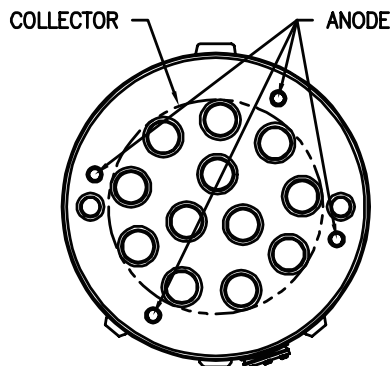

FRONT OF WATER HEATER
D100L(199,250,270,300)
D65T(370,399)

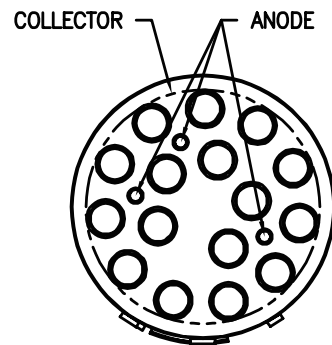

FRONT OF WATER HEATER
D80T(425,505)

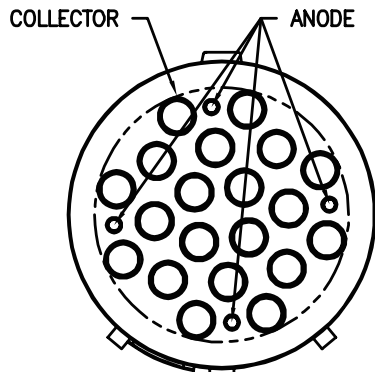

FRONT OF WATER HEATER
D80L(399,450,505)

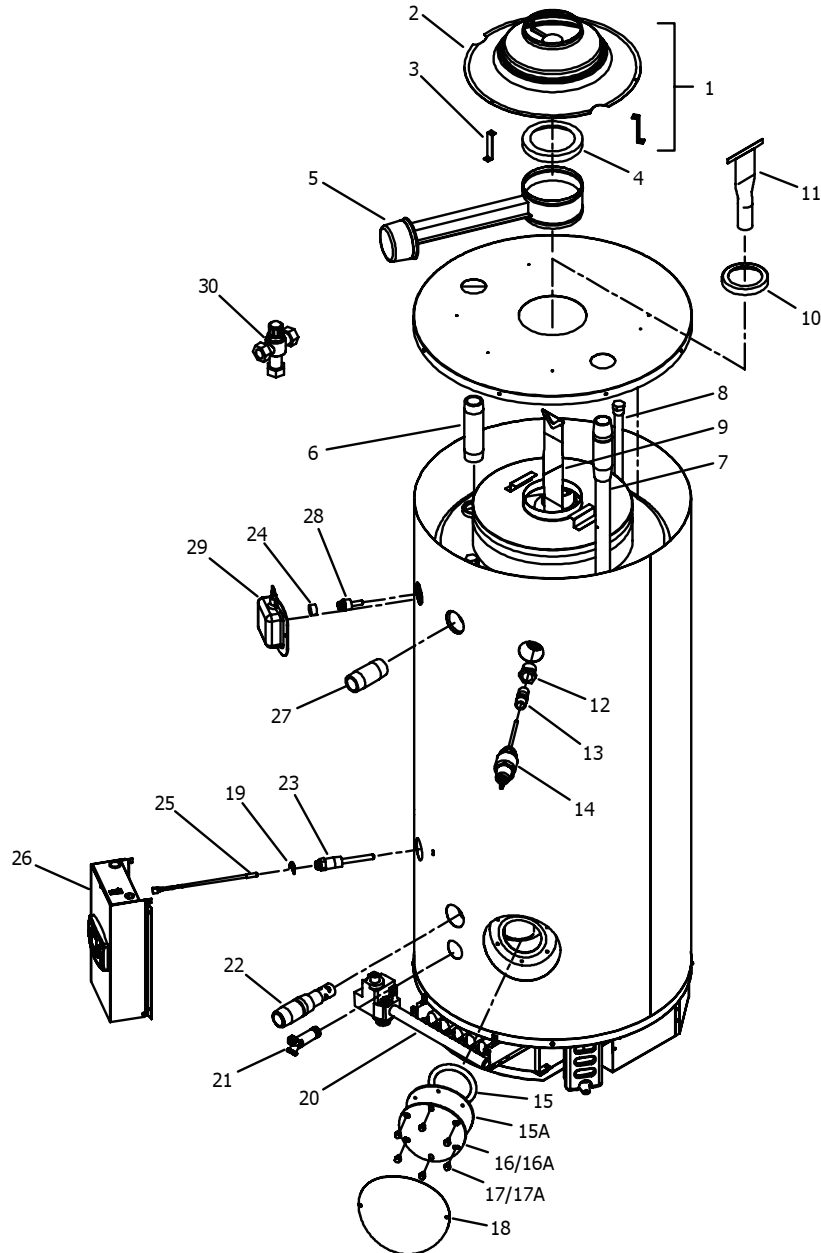

- 1. Draft Diverter w/Leg Kit
- 2. Draft Diverter
- 3. Draft Diverter Leg
- 4. Damper Outlet Reducer
- 5. Flue Damper
- 6. Hot Outlet Nipple
- 7. Cold Water Inlet Dip Tube
- 8. Hex Head Anode
- 9. Flue Baffle
- 10. Flue Reducer

- 11. Flue Core
- 12. 1" x 3/4" Reducer Bushing
- 13. Nipple T&P Valve
- 14. T&P Valve
- 15. Cleanout O-Ring
- 15A. Cleanout Gasket (ASME)
- 16. Cleanout Access Cover
- 16A. Cleanout Access Cover (ASME)
- 17. Cleanout Cover Screw
- 17A. Cleanout Cover Screw (ASME)
- 18. Cleanout Jacket Cover
- 19. Thermostat Sensor Clip

- 20. Burner Assembly Complete
- 21. Brass Drain Valve
- 22. Cold Water Inlet Nipple (side)
- 23. Thermostat Well
- 24. Damper Harness
- 25. Lower Thermostat Sensor
- 26. Control Box Assembly Complete
- 27. Hot Water Outlet Nipple (side)
- 28. Upper Thermostat
- 29. Utility Cover
- 30. ASSE Approved Mixing Valve
- 31. Pipe Plug 3/4 NPT

Generic Parts List

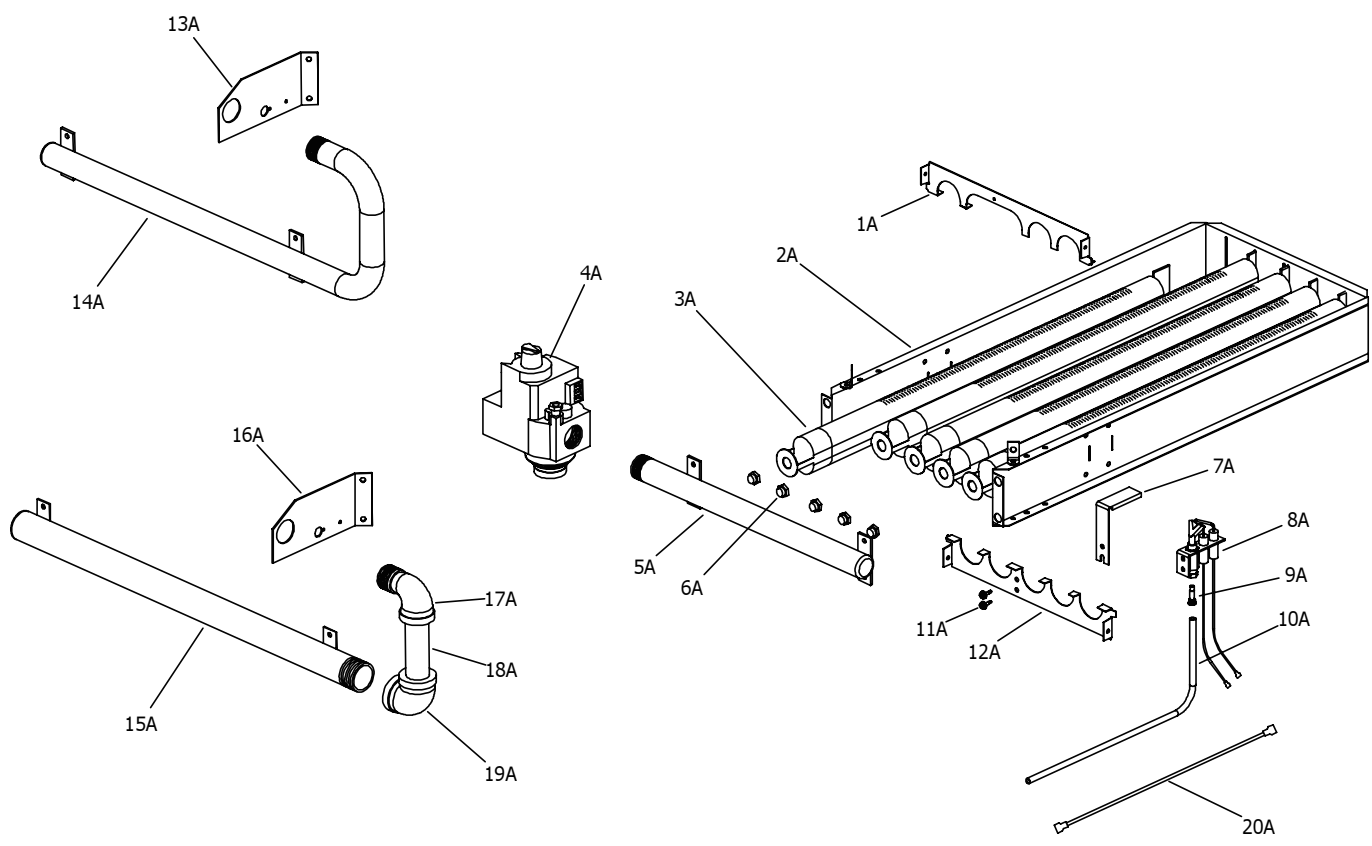

- 1A. Draft Panel
- 2A. Burner Rack
- 3A. Burner Tube
- 4A. Gas Valve
- 5A. Burner Manifold
- 6A. Main Burner Orifice
- 7A. Pilot Shield
- 8A. Pilot Burner
- 9A. Pilot Orifice
- 10A. Pilot Tubing
- 11A. Pilot Mounting Screw
- 12A. Burner Tube Support
- 13A. Manifold Bracket
- 14A. C-Cane Manifold
- 15A. Manifold Straight
- 16A. Manifold Bracket
- 17A. 90° Street Elbow Black
- 18A. 1" Down Pipe Nipple Black
- 19A. 1" 90° Elbow Black
- 20A. Ground Wire

Generic Parts List

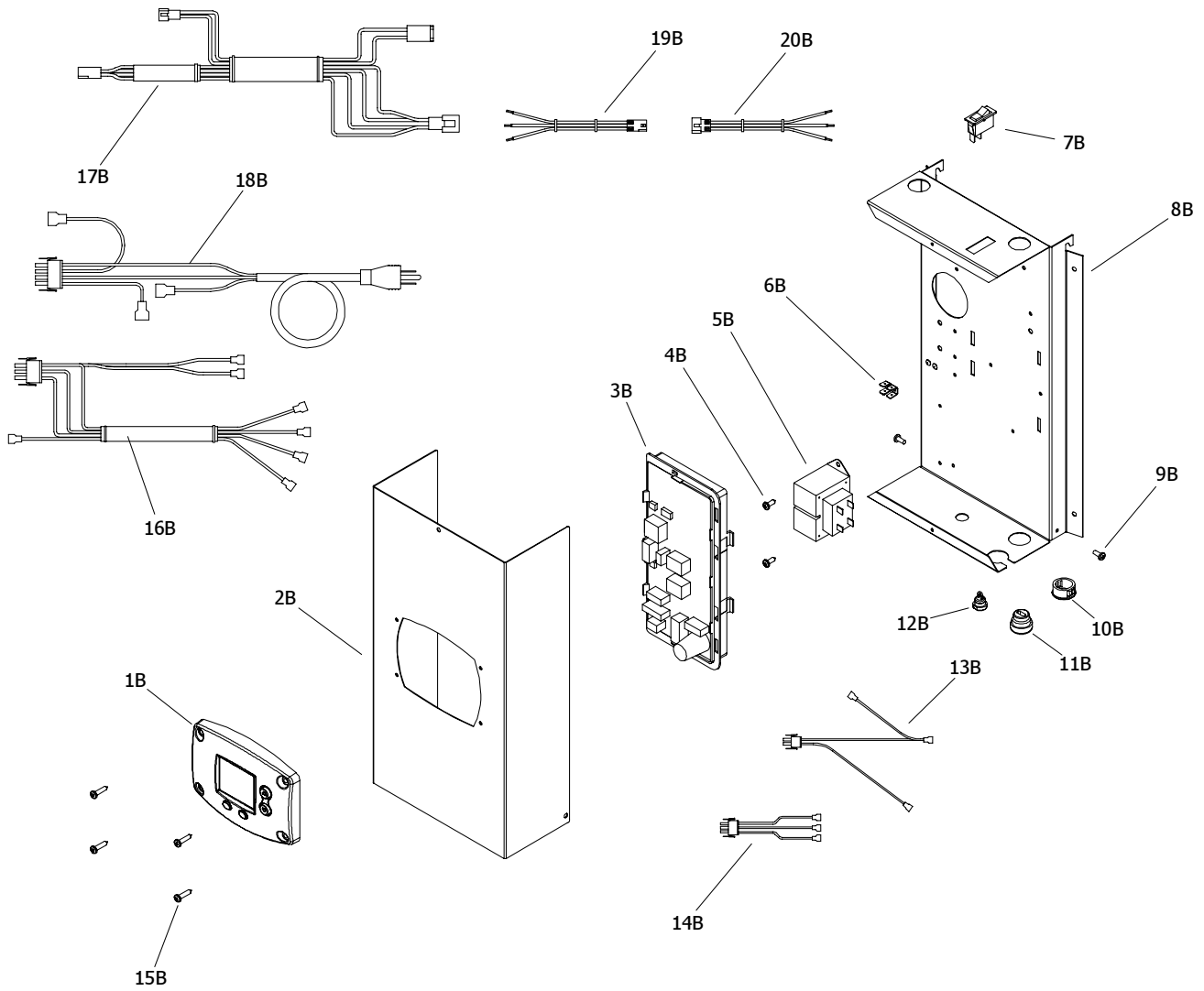

- 1B. Temperature Display
- 2B. Control Box Cover
- 3B. Integrated Control Board
- 4B. Screw 8-16 X 1/2 PHCR
- 5B. Transformer
- 6B. Ground Lug
- 7B. On/Off Switch
- 8B. Control Box Panel
- 9B. Screw 8/32 X 1/4 PHCR
- 10B. 7/8" Snap Bushing

- 11B. Power Cord Strain Relief
- 12B. Pilot Wire Strain Relief
- 13B. Secondary Transformer Wiring Harness
- 14B. Primary Transformer Wiring Harness
- 15B. Screw 8-18 x 3/4 PHCR
- 16B. Gas Valve Control Wiring Harness
- 17B. Damper Wiring Harness
- 18B. Power Cord
- 19B. Display Control Wiring Harness
- 20B. Display Cover Wiring Harness



BRADFORD WHITE®

W A T E R H E A T E R S

Ambler, PA

For U.S. and Canada field service,
contact your professional installer or
local Bradford White sales representative.

Sales/800-523-2931
Fax/215-641-1670
Parts Fax/215-641-2180

Technical Support/800-334-3393
Fax/269-795-1089

Warranty/800-531-2111
Fax/269-795-1089

International:
Telephone/215-641-9400
Telefax/215-641-9750



BRADFORD WHITE-CANADA® INC.

Mississauga, ON

Sales/866-690-0961
905-238-0100

Fax/905-238-0105

Technical Support/800-334-3393

Email

parts@bradfordwhite.com
techserv@bradfordwhite.com

www.bradfordwhite.com