



CAM AND GROOVE **A**

Aluminum, Brass, 316 & 304 Stainless, Cast Iron, Poly, Ny-glass	1 - 8
Seal Fast Self-Locking Couplers	9
Crimp Cam & Groove w/ Interlock	10
Seal Fast Aluminum, Brass, Stainless, Banjo Poly	11, 12
BSP Adapters and Couplers, Flanged Couplers & Adapters	13
Banjo 90°, Cam & Groove, Reducing Adapters and Couplers, Pipe Caps	10, 15 - 19
Replacement Handles & Gaskets, Velco Straps, Pressure & Temp. Ratings	14, 16, 20 - 21

FUEL TANKER PRODUCTS **B**

Bottom Loading & Unloading Adapters	22 - 24
Adapter, Coupler, Interlock Valve	24
Gravity Drop, Lockable Dust Cap,for Vapor Recovery	25, 26
Adapters, Couplers for Product and Vapor Elbows, Coaxial	27 - 34
Dry Disconnect Couplings	35 - 37
Safety Clip, Security Chains, Safety Cables	38
Stainless Hex Weld Nipples,T.O.E. Nipples, Hose Barbs	39

UNIVERSAL COUPLINGS **C**

Sandblast Hose Couplings - Alum., Brass, Ny-glass, Cast Iron	40
Crowfoot Couplings, Crowfeet w/Ferrules	41, 42
Ground Joints, Male Spuds	42
Combination Nipples - Stainless, Brass, Aluminum and Poly	43 - 49
Hose Barbs, Hose Stems, Hose Menders	47 - 49
Flanges	50, 51
Black Steel Nipples, Galvanized Steel Nipples	52, 53
Crimping Sleeves - Plated Steel, Stainless 304, Heavy Duty, Light Duty	54 - 57
Foot Valves, Strainers, Threaded Sight Glass, Pump Filters	58, 59
Bauer Type Couplings	60 - 62
Brass, Poly and Aluminum Shank Couplings, Washers	63
Double Bolt, Spiral and Universal Clamps	64



A
B
C
D
E
F
G
H
I
J
K
L
M
N
O
P
S
T

PTFE TAPE AND THREAD SEAL **D**

S'Mooth™ Thread Sealant, PTFE Joint Sealant	65
PTFE Tape, PTFE Thread Sealant	66
Anaerobic Sealing Compounds	67, 68
PTFE Spray, RTV Silicone Adhesive	69
Instant Adhesive, Adhesive Spray	70
All Purpose Lubricant, Chain & Cable Lube, Silicone Lubricant	71
Belt Dressing, Galvanizing Spray, Thread Lockers	72
Anti-Seize	73 - 75

PRESSURE GAUGES & THERMOMETERS **E**

Thermometers, Thermowell	76
High Quality Gauges	79
Pressure & Vacuum Gauges	80, 81
Liquid Filled - Hydraulic and Ammonia	82 - 85
Process Gauges, Needle Valves	86
Needle Valves, Pressure Snubbers and Siphons	87

HOSE CLAMPS **F**

Seal Fast Double Bolt Clamps, Spiral, Universal	88
Seal Fast 1-Bolt & HD 2-Bolt Clamps, Wide Band Clamps	89, 90
Mikalor Bolt Hose Clamps	91
Seal Fast Center Punch Tool, SS Preformed Clamps	92
Seal Fast Worm Gear Clamps	93
Seal Fast Worm Gear Clamps - all Stainless, Clamp Kit	94
Seal Fast Hi-Torque, Constant Torque, Liner Clamps	95
Seal Fast Quick Release, 2-Ear Clamps	96
Fast Lok Tools	97, 98
Fast Lok F Preformed Clamps	98
Fast Lok K Clamps, Strapping & Buckles	99
Fast Lok Open End, J Series	100
Breeze Power Seal Clamps, Make-A-Clamp	101
Breeze Aero Seal Clamps, Hi-Torque	102
Liner Clamps, Constant Torque	103
Oetiker 2-Ear Clamps, Pincers and Tools, 1-Ear Clamps	104, 105
Oetiker Service Kits	106



BANJO **G**

Dry-Disconnect, Stubby Valve	107
Cam and Groove, Polypropylene	108
Spool Adapters, Poly Cam Lever Couplings	109
Ball Valves, Nozzle	110
Flanges, Poly & Stainless Bulkhead Fittings	111
Line Strainers, Replacement Mesh - LS, Poly 90°Cam & Groove	112
Y and T Strainers, Replacement Mesh - LST	113
Pipe Nipple, Reducers, Menders, Pipe Cross	114
Pipe Fittings, Elbows, Tees, Hose Barbs, Pipe Cap	115

GRIP-ON FITTINGS **H**

Push-On Air Hose and Fittings, Grip-on Fittings	116 - 118
Garden Hose Fittings	118, 119
Garden Hose, Garden Hose Nozzles	120
Brass Menders, Brass Hose Fittings	121
Brass Ferrules	122
Crimping Tools & Dies	123

PNEUMATIC PRODUCTS **I**

Sockets and Plugs	124 - 126
Pressure Washer Hose & Couplings	126
Recoil Hose, Blow Guns, Air & Water Hose Assembly	127

HYDRAULIC **J**

Hydraulic Quick-Connect	128
Hydraulic Hose Couplings	129- 155
Anaerobic Thread Sealant	155



A
B
C
D
E
F
G
H
I
J
K
L
M
N
O
P
S
T

RUBBER HOSE **K**

Pressure Washer Hose, Hose End Restrictors	156
Hydraulic Hose, R1, R2, R12, R13, 4SH, Oil Return	157 - 160
Protective Sleeves, Fire Jackets, Fiberglass Sleeving	161, 162
Petroleum Drop Hose, Slinky Sleeves	163
Air & Water Hose, Air Hose, Fuel Oil Delivery, Wire Air, Textile Cord	164 - 166
Water Suction, Steam Hose	167 - 168
Water Discharge 2-Ply, 4-Ply	169
Crude Oil Suction, Tank Truck	170-173
Corrugated Petroleum Hose, Oil Discharge, Bulk Material	174
Chemical Hose, UHMW Chemical	175, 176
Plaster, Grout & Concrete Hose, Hot Air Blower, Cement Discharge	177
Sandblast Hose & Couplings	178

NITRILE - PVC **L**

Seal Fast Nitril 10 & 20	179
--------------------------	-----

PVC HOSE **M**

Suction - Green or Clear, Sludge, All Clear FDA	180 - 183
Standard & Medium, HD Duty Discharge, Ag Spray Hose	184, 185
Multi-Purpose Air & Water, Ducting, Clear Tubing	186
Clear Braid, Gardenflex, Rubber & Octagon Garden Hose	187

GOODYEAR PVC HOSE **N**

Suction Hose, Blue Discharge	188
------------------------------	-----

FIRE HOSE **O**

Mill Discharge Hose	189 - 193
Single Jacket, UL Label	194 - 197
Double Jacket	198, 199
Nitrile Covered, Coated Single Jacket, Forestry Hose	200 - 202



FIRE HOSE FITTINGS AND ACCESSORIES **P**

Brass Bowl Couplings, Expansion Rings	203
Aluminum Bowl Couplings, Gaskets	204
Aluminum Hard Coat Coupling, Hex Nipple, Brass Swivels	205, 206
Adapters, Plug, Cap and Chain	206
Siamese & Wyes, Hydrant Wye, Gate Valve	207, 214 - 216
Siamese Valve, Plain Wye, Gate & Angle Valve, Spanner Wrench	207, 214, 220
Sidewalk Siamese, Escutcheon Plate, Single Clapper	208
Fog Nozzles, Hose Pipes, GPM & TPI Information	209, 210
Master Stream Nozzles, Marine Nozzle, Shut-Off Nozzle	211 - 213
Gated Wyes, Industrial Monitors	214, 216 - 218
Stortz Fittings	219
Universal Spanner, Adjustable and Hydrant Wrench, Hose Reels	220

VALVES **S**

Needle Valves	221
Brass, Lead-Free, Stainless & Carbon Ball Valves, Gas Valve, Butterfly Valve	222 - 224
Gate, Globe, Oil & Molasses, Bibb Faucet, Garden Hose Wye	225
Check Valve, Y-Type Strainers	226
Air Cocks - Brass	77, 78, 227, 228
Gas Service Cocks	228

SHEET RUBBER **T**

Matting, Cloth Insert, Nitrile Sheet	229
Skirtboard, Corrugated Runner Matting	230
SBR	231
Commercial Grade Neoprene	232, 233
Commercial EPDM, White Nitrile FDA, Nylon Inserted SBR	233



A
B
C
D
E
F
G
H
I
J
K
L
M
N
O
P
S
T

Terms of Sale to Qualified Distributors

TERMS:

½% 10 Days, net 30 Days

FREIGHT:

All shipments are made FOB Seal Fast, Inc. or Point of Manufacturer. (Applies to shipments from Houston warehouse only.) Freight Prepaid on \$1000 net couplings only excluding Rubber Hose, PVC Hose, Fire Hose and Sheet Rubber. Freight prepaid on \$2500 net on all combined products. Seal Fast, Inc. Reserves the right to determine the most economical shipping method on all prepaid shipments. Applies to Continental United States, excluding Alaska and Hawaii. Bus Charges - Houston warehouse to Bus Depot \$4.50. **Any evidence of shortage must be reported to Seal Fast, Inc. within 10 days. Any damage to hose/hoses, etc. customer is responsible for filing a claim with the delivery carrier within 10 days. Seal Fast will not issue credit.**

WARRANTY:

Products are warranted against defects in workmanship and defects in material. Products having such defects will be replaced or credited as Seal Fast elects. Liability is limited to the invoice value of the defective item. Our responsibility shall not exceed the original purchase price of the defective product. In any event, Seal Fast, Inc. shall not be held responsible for any special or consequential damages.

RETURNED GOODS:

If for any reason you wish to return goods, please contact Seal Fast Inc. for prior authorization number. Goods must be returned within 30 days and must be in new and resaleable condition. Minimum handling charge is 15%

All discrepancies in shipment / invoice must be reported within 10 days of receipt of goods.

PROMPT PAYMENT:

Orders receive preferred treatment when the account is paid promptly. Orders may be held up if any unpaid invoice exceeds 30 days.

MINIMUM INVOICE:

All invoices are subject to a minimum billing charge of \$25.00 net. Returned checks are subject to a \$25.00 service charge.

GENERAL:

Orders will be accepted subject to delays caused by accident, strike, fire or other causes beyond the control of the seller including failure of seller's suppliers to deliver. Prices, discounts and other specifications are subject to change without notice. All prices are subject to any applicable taxes imposed. The possessions of this price schedule is not to be construed as an offer to sell at the prices shown. Special price for volume quotes will be accepted in writing only.

PLEASE NOTE:

Extra care is taken in the preparation of this literature but Seal Fast, Inc. is not responsible for any inadvertent typographical errors or omissions.

STOCKING WAREHOUSES

SEAL FAST, INC.
5603 Harvey Wilson Dr.
Houston, TX 77020
(713) 675-6324 or 800-231-0734
FAX (713) 675-0146 or 800-681-1515
E-mail sales@sealfast.com

Far West Sales & MKT
1050 N. Eliseo Flex Jr Way #109
Avondale, AZ 85323
(602) 653-3306
Fax (623) 455-3660

R & J PRODUCTS
dba ANDERSON HUGHES
228 Distribution Drive
Birmingham, AL 35209
(800) 886-4673
(205) 942-7564
Fax (205) 942-5498

D & C SALES INC.
14704 E. 33rd Place #F
Aurora CO 80011
(303) 373-2121
Fax (303) 373-5306

THE WAGNER GROUP
125 State St.
P O Box 1683
Elkhart, IN 46516
(574) 294-2769
Fax (574) 522-2083



Lined area for notes with 20 horizontal lines.

A
B
C
D
E
F
G
H
I
J
K
L
M
N
O
P
S
T



CAM AND GROOVE COUPLINGS



Cam and Groove Couplings

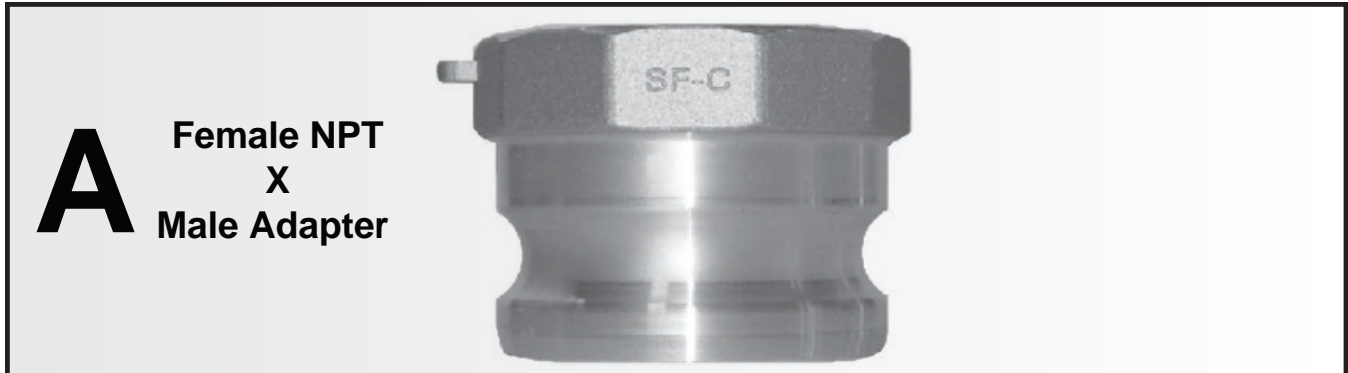

Size	Aluminum		Brass		316 SS		304 SS	
	Part #	List Price	Part #	List Price	Part #	List Price	Part #	List Price
1/2"	A 050IAL	\$2.55	A 050IBR	\$4.91	A 050SS	\$5.09	A 050SS304	\$4.19
1/2 x 3/4"	A 05075IAL	\$3.57	A 05075IBR	\$9.06	A 05075SS	\$9.60	--	--
3/4"	A 075IAL	\$2.55	A 075IBR	\$4.98	A 075SS	\$6.13	A 075SS304	\$5.00
1"	A 100IAL	\$2.83	A 100IBR	\$6.34	A 100SS	\$8.45	A 100SS304	\$6.77
1-1/4"	A 125IAL	\$3.33	A 125IBR	\$8.96	A 125SS	\$11.79	A 125SS304	\$9.25
1-1/2"	A 150IAL	\$3.17	A 150IBR	\$10.66	A 150SS	\$12.81	A 150SS304	\$11.42
2"	A 200IAL	\$3.68	A 200IBR	\$13.21	A 200SS	\$18.68	A 200SS304	\$15.47
2-1/2"	A 250IAL	\$5.85	A 250IBR	\$18.58	A 250SS	\$28.40	A 250SS304	\$24.25
3"	A 300IAL	\$6.74	A 300IBR	\$25.47	A 300SS	\$34.25	A 300SS304	\$26.75
4"	A 400IAL	\$9.81	A 400IBR	\$38.58	A 400SS	\$57.74	A 400SS304	\$49.53
5"	A 500ASTMAL	\$17.92	B 500ASTMBR	\$53.21	A 500SS	\$104.43	A 500SS304	\$81.42
6"	A 600IAL	\$19.81	A 600IBR	\$80.30	A 600SS	\$133.02	A 600SS304	\$106.70
8"	A 800IALNAE	\$77.98	--	--	--	--	--	--
8"	A 800IALPTK	\$84.15	--	--	--	--	--	--
10"	A 1000IAL	\$369.81	--	--	--	--	--	--
12"	A 1200IAL	\$330.19	--	--	--	--	--	--

Size	Plated Iron		Poly		Nyglass	
	Part #	List Price	Part #	List Price	Part #	List Price
1/2" x 3/4"	--	--	A 050075PP	\$1.17	--	--
3/4"	--	--	A 075PP	\$0.89	A 075NG	\$1.28
1"	A 100CI	\$3.77	A 100PP	\$0.89	A 100NG	\$1.87
1-1/4"	--	--	**A 125PP	\$1.58	**A 125NG	\$3.00
1-1/2"	A 150CI	\$6.51	**A 150PP	\$1.42	**A 150NG	\$2.75
2"	A 200CI	\$7.74	A 200PP	\$2.11	A 200NG	\$3.49
3"	A 300CI	\$12.92	A 300PP	\$3.36	A 300NG	\$6.70
4"	A 400CI	\$23.49	A 400PP	\$9.23	A 400NG	\$15.64
5"	A 500CI	\$26.32	--	--	--	--
6"	A 600CI	\$33.83	--	--	--	--

** Available as: 1-1/4 adapter or coupler X 1-1/4 NPT
Please specify: 1-1/2 adapter or coupler X 1-1/4 NPT
1-1/2 adapter or coupler X 1-1/2 NPT

Cam and Groove Couplings

B

Female Coupler
X
Male NPT



All Couplers Supplied
With Buna-N Gaskets

Size	Aluminum		Brass		316 SS		304 SS	
	Part #	List Price	Part #	List Price	Part #	List Price	Part #	List Price
1/2"	B 050IAL	\$5.00	B 050IBR	\$7.74	B 050SS	\$10.28	B 050SS304	\$8.47
1/2 x 3/4"	B 05075IAL	\$6.98	B 05075IBR	\$11.28	B 05075SS	\$14.62	--	--
3/4"	B 075IAL	\$5.06	B 075IBR	\$9.53	B 075SS	\$11.04	B 075SS304	\$9.53
1"	B 100IAL	\$5.94	B 100IBR	\$12.55	B 100SS	\$14.81	B 100SS304	\$12.45
1-1/4"	B 125IAL	\$7.83	B 125IBR	\$18.62	B 125SS	\$21.68	B 125SS304	\$17.51
1-1/2"	B 150IAL	\$7.40	B 150IBR	\$16.04	B 150SS	\$20.85	B 150SS304	\$19.70
2"	B 200IAL	\$8.00	B 200IBR	\$20.66	B 200SS	\$28.77	B 200SS304	\$23.96
2-1/2"	B 250IAL	\$12.17	B 250IBR	\$33.55	B 250SS	\$38.96	B 250SS304	\$33.02
3"	B 300IAL	\$13.11	B 300IBR	\$35.91	B 300SS	\$52.08	B 300SS304	\$46.81
4"	B 400IAL	\$16.89	B 400IBR	\$55.28	B 400SS	\$68.26	B 400SS304	\$60.87
5"	B 500ASTMAL	\$31.23	B 500ASTMBR	\$82.58	B 500SS	\$117.55	B 500SS304	\$97.13
6"	B 600IAL	\$35.09	B 600IBR	\$124.30	B 600SS	\$148.21	B 600SS304	\$137.53
8"	B 800IALPTK	\$187.92	--	--	--	--	--	--

Size	Plated Iron		Poly		Nyglass	
	Part #	List Price	Part #	List Price	Part #	List Price
1/2" x 3/4"	--	--	B 050075PP	\$3.96	--	--
3/4"	--	--	B 075PP	\$3.45	B 075NG	\$4.49
1"	B 100CI	\$11.89	B 100PP	\$4.06	B 100NG	\$5.34
1-1/4"	--	--	**B 125PP	\$6.13	**B 125NG	\$8.85
1-1/2"	B 150CI	\$15.38	**B 150PP	\$6.23	**B 150NG	\$7.45
2"	B 200CI	\$12.64	B 200PP	\$7.51	B 200NG	\$9.13
3"	B 300CI	\$19.58	B 300PP	\$10.55	B 300NG	\$14.58
4"	B 400CI	\$27.83	B 400PP	\$21.89	B 400NG	\$30.19
5"	B 500CI	\$51.89	--	--	--	--
6"	B 600CI	\$67.87	--	--	--	--

Note: All Cam & Groove Stainless Bodies are 316 Investment with 304 Handles.
All 4" Poly and Ny-Glass couplers have 4 handles.

** Available as: 1-1/4 adapter or coupler X 1-1/4 NPT
Please specify: 1-1/2 adapter or coupler X 1-1/4 NPT
1-1/2 adapter or coupler X 1-1/2 NPT



CAM AND GROOVE COUPLINGS

A

Cam and Groove Couplings

C Female Coupler
X
Hose Shank



All Couplers Supplied
With Buna-N Gaskets

Size	Aluminum		Brass		316 SS		304 SS	
	Part #	List Price	Part #	List Price	Part #	List Price	Part #	List Price
1/2"	C 050IAL	\$5.19	C 050IBR	\$8.11	C 050SS	\$9.62	C 050SS304	\$8.49
1/2 x 3/4"	C 05075IAL	\$6.04	C 05075IBR	\$13.11	C 05075SS	\$15.83	--	--
3/4"	C 075IAL	\$5.38	C 075IBR	\$9.81	C 075SS	\$12.17	C 075SS304	\$10.94
1"	C 100IAL	\$5.34	C 100IBR	\$13.02	C 100SS	\$14.36	C 100SS304	\$11.36
1-1/4"	C 125IAL	\$7.53	C 125IBR	\$18.57	C 125SS	\$22.23	C 125SS304	\$18.21
1-1/2"	C 150IAL	\$8.21	C 150IBR	\$18.96	C 150SS	\$21.51	C 150SS304	\$19.62
2"	C 200IAL	\$9.11	C 200IBR	\$24.72	C 200SS	\$28.02	C 200SS304	\$25.75
2-1/2"	C 250IAL	\$12.30	C 250IBR	\$34.68	C 250SS	\$35.91	C 250SS304	\$32.89
3"	C 300IAL	\$14.34	C 300IBR	\$44.34	C 300SS	\$51.89	C 300SS304	\$47.08
4"	C 400IAL	\$21.89	C 400IBR	\$65.94	C 400SS	\$80.49	C 400SS304	\$72.32
5"	C 500ASTMAL	\$34.15	C 500ASTMBR	\$115.38	C 500SS	\$136.57	C 500SS304	\$109.74
6"	C 600IAL	\$48.68	C 600IBR	\$173.89	C 600SS	\$224.15	C 600SS304	\$189.40
8"	C 800IALNAE	\$177.81	--	--	--	--	--	--
8"	C 800IALPTK	\$178.42	--	--	--	--	--	--
10"	C 1000IAL	\$468.91	--	--	--	--	--	--
12"	C 1200IAL	\$525.47	--	--	--	--	--	--

Size	Plated Iron		Poly		Nyglass	
	Part #	List Price	Part #	List Price	Part #	List Price
1/2" x 3/4"	--	--	C 050075PP	\$3.68	--	--
3/4"	--	--	C 075PP	\$3.58	C 075NG	\$3.87
1"	C 100CI	\$12.23	C 100PP	\$4.06	C 100NG	\$5.19
1-1/4"	--	--	**C 125PP	\$6.32	**C 125NG	\$7.92
1-1/2"	C 150CI	\$12.70	**C 150PP	\$6.42	**C 150NG	\$8.30
2"	C 200CI	\$16.77	C 200PP	\$7.51	C 200NG	\$9.34
3"	C 300CI	\$27.34	C 300PP	\$11.38	C 300NG	\$17.83
4"	C 400CI	\$36.60	C 400PP	\$22.92	C 400NG	\$35.43
5"	C 500CI	\$60.38	--	--	--	--
6"	C 600CI	\$68.23	--	--	--	--

Note: All Cam & Groove Stainless Bodies are 316 Investment with 304 Handles.
All 4" Poly and Ny-Glass couplers have 4 handles.

** Available as: 1-1/4 adapter or coupler X 1-1/4 NPT
Please specify: 1-1/2 adapter or coupler X 1-1/4 NPT
1-1/2 adapter or coupler X 1-1/2 NPT

Cam and Groove Couplings

D Female Coupler
X
Female NPT



All Couplers Supplied
With Buna-N Gaskets

Size	Aluminum		Brass		316 SS		304 SS	
	Part #	List Price	Part #	List Price	Part #	List Price	Part #	List Price
1/2"	D 050IAL	\$5.75	D 050IBR	\$9.34	D 050SS	\$10.55	D 050SS304	\$8.96
1/2 x 3/4"	D 05075IAL	\$7.08	D 05075IBR	\$14.62	D 05075SS	\$17.45	--	--
3/4"	D 075IAL	\$5.19	D 075IBR	\$9.53	D 075SS	\$11.51	D 075SS304	\$9.347
1"	D 100IAL	\$6.15	D 100IBR	\$12.43	D 100SS	\$15.00	D 100SS304	\$12.17
1-1/4"	D 125IAL	\$7.62	D 125IBR	\$18.77	D 125SS	\$20.47	D 125SS304	\$16.42
1-1/2"	D 150IAL	\$7.64	D 150IBR	\$17.36	D 150SS	\$20.72	D 150SS304	\$19.81
2"	D 200IAL	\$8.62	D 200IBR	\$21.23	D 200SS	\$26.83	D 200SS304	\$25.02
2-1/2"	D 250IAL	\$13.08	D 250IBR	\$33.30	D 250SS	\$39.36	D 250SS304	\$35.79
3"	D 300IAL	\$13.19	D 300IBR	\$36.21	D 300SS	\$52.36	D 300SS304	\$46.91
4"	D 400IAL	\$19.34	D 400IBR	\$58.11	D 400SS	\$75.75	D 400SS304	\$68.74
5"	D 500ASTMAL	\$31.42	D 500ASTMBR	\$85.85	D 500SS	\$128.00	D 500SS304	\$105.58
6"	D 600IAL	\$38.68	D 600IBR	\$137.32	D 600SS	\$172.08	D 600SS304	\$149.91
8"	D 800IALNAE	\$151.74	--	--	--	--	--	--
8"	D 800IALPTK	\$159.66	--	--	--	--	--	--
10"	D 1000IAL	\$415.09	--	--	--	--	--	--
12"	D 1200IAL	\$517.42	--	--	--	--	--	--

Size	Plated Iron		Poly		Nyglass	
	Part #	List Price	Part #	List Price	Part #	List Price
1/2" x 3/4"	--	--	D 050075PP	\$3.96	--	--
3/4"	--	--	D 075PP	\$3.64	D 075NG	\$4.43
1"	D 100CI	\$10.55	D 100PP	\$4.21	D 100NG	\$5.13
1-1/4"	--	--	**D 125PP	\$5.94	**D 125NG	\$8.72
1-1/2"	D 150CI	\$11.70	**D 150PP	\$6.60	**D 150NG	\$7.92
2"	D 200CI	\$14.43	D 200PP	\$7.64	D 200NG	\$9.58
3"	D 300CI	\$25.00	D 300PP	\$11.23	D 300NG	\$16.58
4"	D 400CI	\$36.17	D 400PP	\$22.45	D 400NG	\$30.06
5"	D 500CI	\$50.00	--	--	--	--
6"	D 600CI	\$68.87	--	--	--	--

Note: All Cam & Groove Stainless Bodies are 316 Investment with 304 Handles.
All 4" Poly and Ny-Glass couplers have 4 handles.

** Available as: 1-1/4 adapter or coupler X 1-1/4 NPT
Please specify: 1-1/2 adapter or coupler X 1-1/4 NPT
1-1/2 adapter or coupler X 1-1/2 NPT



CAM AND GROOVE COUPLINGS

A

Cam and Groove Couplings

E

**Male Adapter
X
Hose Shank**



Size	Aluminum		Brass		316 SS		304 SS	
	Part #	List Price	Part #	List Price	Part #	List Price	Part #	List Price
1/2"	E 050IAL	\$2.64	E 050IBR	\$5.75	E 050SS	\$4.81	E 050SS304	\$3.87
1/2 x 3/4"	E 05075IAL	\$3.57	E 05075IBR	\$8.49	E 05075SS	\$8.85	--	--
3/4"	E 075IAL	\$3.02	E 075IBR	\$7.64	E 075SS	\$6.11	E 075SS304	\$4.81
1"	E 100IAL	\$3.38	E 100IBR	\$9.06	E 100SS	\$8.26	E 100SS304	\$6.51
1-1/4"	E 125IAL	\$4.08	E 125IBR	\$12.36	E 125SS	\$13.38	E 125SS304	\$10.53
1-1/2"	E 150IAL	\$4.34	E 150IBR	\$14.57	E 150SS	\$14.83	E 150SS304	\$13.40
2"	E 200IAL	\$6.13	E 200IBR	\$20.15	E 200SS	\$23.96	E 200SS304	\$20.74
2-1/2"	E 250IAL	\$8.36	E 250IBR	\$31.04	E 250SS	\$32.49	E 250SS304	\$28.53
3"	E 300IAL	\$9.81	E 300IBR	\$40.53	E 300SS	\$45.30	E 300SS304	\$39.96
4"	E 400IAL	\$16.32	E 400IBR	\$60.34	E 400SS	\$72.47	E 400SS304	\$62.74
5"	E 500ASTMAL	\$28.26	E 500ASTMBR	\$114.72	E 500SS	\$145.17	E 500SS304	\$111.89
6"	E 600IAL	\$37.08	E 600IBR	\$159.72	E 600SS	\$206.60	E 600SS304	\$167.43
8"	E 800IALNAE	\$110.47	--	--	--	--	--	--
8"	E 800IALPTK	\$127.36	--	--	--	--	--	--
10"	E 1000IAL	\$248.68	--	--	--	--	--	--
12"	E 1200IAL	\$370.75	--	--	--	--	--	--

Size	Plated Iron		Poly		Nyglass	
	Part #	List Price	Part #	List Price	Part #	List Price
1/2" x 3/4"	--	--	E 050075PP	\$0.94	--	--
3/4"	--	--	E 075PP	\$0.77	E 075NG	\$1.49
1"	E 100CI	\$7.92	E 100PP	\$0.94	E 100NG	\$1.87
1-1/4"	--	--	**E 125PP	\$1.89	**E 125NG	\$2.74
1-1/2"	E 150CI	\$7.92	**E 150PP	\$1.58	**E 150NG	\$2.98
2"	E 200CI	\$10.28	E 200PP	\$2.57	E 200NG	\$4.55
3"	E 300CI	\$17.53	E 300PP	\$4.25	E 300NG	\$10.94
4"	E 400CI	\$30.85	E 400PP	\$10.53	E 400NG	\$20.66
5"	E 500CI	\$53.68	--	--	--	--
6"	E 600CI	\$45.00	--	--	--	--

Cam and Groove Couplings

F

Male Adapter
X
Male NPT



Size	Aluminum		Brass		316 SS		304 SS	
	Part #	List Price	Part #	List Price	Part #	List Price	Part #	List Price
1/2"	F 050IAL	\$3.21	F 050IBR	\$5.57	F 050SS	\$5.19	F 050SS304	\$4.25
1/2 x 3/4"	F 05075IAL	\$3.49	F 05075IBR	\$8.77	F 05075SS	\$7.83	--	--
3/4"	F 075IAL	\$2.92	F 075IBR	\$6.57	F 075SS	\$6.23	F 075SS304	\$5.09
1"	F 100IAL	\$2.98	F 100IBR	\$8.08	F 100SS	\$8.87	F 100SS304	\$7.20
1-1/4"	F 125IAL	\$4.34	F 125IBR	\$12.45	F 125SS	\$12.45	F 125SS304	\$9.94
1-1/2"	F 150IAL	\$3.83	F 150IBR	\$10.85	F 150SS	\$14.43	F 150SS304	\$12.94
2"	F 200IAL	\$4.96	F 200IBR	\$16.89	F 200SS	\$21.62	F 200SS304	\$18.49
2-1/2"	F 250IAL	\$7.83	F 250IBR	\$29.77	F 250SS	\$33.58	F 250SS304	\$29.72
3"	F 300IAL	\$8.58	F 300IBR	\$33.68	F 300SS	\$42.75	F 300SS304	\$37.98
4"	F 400IAL	\$14.75	F 400IBR	\$56.98	F 400SS	\$68.87	F 400SS304	\$59.43
5"	F 500ASTMAL	\$24.13	F 500ASTMBR	\$79.13	F 500SS	\$134.34	F 500SS304	\$104.91
6"	F 600IAL	\$33.02	F 600IBR	\$107.51	F 600SS	\$165.09	F 600SS304	\$144.64
8"	F 800IALNAE	\$111.13	--	--	--	--	--	--
8"	F 800IALPTK	\$95.94	--	--	--	--	--	--
10"	F 1000IAL	\$228.68	--	--	--	--	--	--
12"	F 1200IAL	\$313.21	--	--	--	--	--	--

Size	Plated Iron		Poly		Nyglass	
	Part #	List Price	Part #	List Price	Part #	List Price
1/2" x 3/4"	--	--	F 050075PP	\$1.19	--	--
3/4"	--	--	F 075PP	\$0.77	F 075NG	\$1.19
1"	F 100CI	\$10.94	F 100PP	\$0.94	F 100NG	\$1.81
1-1/4"	--	--	**F 125PP	\$1.68	**F 125NG	\$3.19
1-1/2"	F 150CI	\$6.42	**F 150PP	\$1.51	**F 150NG	\$2.92
2"	F 200CI	\$9.96	F 200PP	\$2.26	F 200NG	\$4.38
3"	F 300CI	\$17.92	F 300PP	\$3.68	F 300NG	\$8.77
4"	F 400CI	\$22.66	F 400PP	\$10.47	F 400NG	\$16.89
5"	F 500CI	\$48.96	--	--	--	--
6"	F 600CI	\$58.30	--	--	--	--



CAM AND GROOVE COUPLINGS

A

Cam and Groove Couplings

DC



**All Couplers Supplied
With Buna-N Gaskets**

Dust Cap Coupler

Size	Aluminum		Brass		316 SS		304 SS	
	Part #	List Price	Part #	List Price	Part #	List Price	Part #	List Price
1/2"	DC 050IAL	\$4.53	DC 050IBR	\$7.13	DC 050SS	\$8.87	DC 050SS304	\$7.83
3/4"	DC 075IAL	\$4.72	DC 075IBR	\$8.96	DC 075SS	\$9.06	DC 075SS304	\$8.77
1"	DC 100IAL	\$6.26	DC 100IBR	\$11.60	DC 100SS	\$10.66	DC 100SS304	\$9.15
1-1/4"	DC 125IAL	\$7.45	DC 125IBR	\$16.32	DC 125SS	\$18.68	DC 125SS304	\$17.17
1-1/2"	DC 150IAL	\$6.98	DC 150IBR	\$14.89	DC 150SS	\$18.96	DC 150SS304	\$16.42
2"	DC 200IAL	\$7.70	DC 200IBR	\$17.36	DC 200SS	\$23.66	DC 200SS304	\$20.47
2-1/2"	DC 250IAL	\$9.53	DC 250IBR	\$26.32	DC 250SS	\$25.40	DC 250SS304	\$23.53
3"	DC 300IAL	\$10.94	DC 300IBR	\$29.72	DC 300SS	\$36.38	DC 300SS304	\$35.38
4"	DC 400IAL	\$15.38	DC 400IBR	\$47.15	DC 400SS	\$56.00	DC 400SS304	\$50.85
5"	DC 500ASTMAL	\$24.72	DC 500ASTMBR	\$71.38	DC 500SS	\$97.38	DC 500SS304	\$77.94
6"	DC 600IAL	\$35.09	DC 600IBR	\$99.25	DC 600SS	\$128.91	DC 600SS304	\$115.47
8"	DC 800IALNAE	\$137.45	--	--	--	--	--	--
8"	DC 800IALPTK	\$137.45	--	--	--	--	--	--
10"	DC 1000IAL	\$336.32	--	--	--	--	--	--
12"	DC 1200IAL	\$425.66	--	--	--	--	--	--

Size	Plated Iron		Poly		Nyglass	
	Part #	List Price	Part #	List Price	Part #	List Price
3/4"	--	--	DC 075PP	\$3.11	DC 075NG	\$4.38
1"	DC 100CI	\$14.43	DC 100PP	\$3.96	DC 100NG	\$4.77
1-1/4"	--	--	**DC 125PP	\$5.57	**DC 125NG	\$8.77
1-1/2"	DC 150CI	\$13.58	**DC 150PP	\$6.11	**DC 150NG	\$7.64
2"	DC 200CI	\$13.49	DC 200PP	\$7.26	DC 200NG	\$9.28
3"	DC 300CI	\$19.02	DC 300PP	\$10.85	DC 300NG	\$14.34
4"	DC 400CI	\$23.30	DC 400PP	\$19.43	DC 400NG	\$25.47
5"	DC 500CI	\$53.98	--	--	--	--
6"	DC 600CI	\$56.23	--	--	--	--

Note: All Seal Fast Cam & Groove Stainless Bodies are 316 Investment with 304 Handles.
 * Dust Caps and Dust Plugs are not designed for pressure applications.

** Available as: 1-1/4 adapter or coupler X 1-1/4 NPT
 Please specify: 1-1/2 adapter or coupler X 1-1/4 NPT
 1-1/2 adapter or coupler X 1-1/2 NPT

Cam and Groove Couplings



DP Dust Plug Adapter

Size	Aluminum		Brass		316 SS		304 SS	
	Part #	List Price	Part #	List Price	Part #	List Price	Part #	List Price
1/2"	DP 050IAL	\$2.34	DP 050IBR	\$4.34	DP 050SS	\$2.92	DP 050SS304	\$2.36
3/4"	DP 075IAL	\$2.26	DP 075IBR	\$5.40	DP 075SS	\$3.96	DP 075SS304	\$3.40
1"	DP 100IAL	\$2.51	DP 100IBR	\$6.32	DP 100SS	\$5.40	DP 100SS304	\$4.25
1-1/4"	DP 125IAL	\$2.74	DP 125IBR	\$8.68	DP 125SS	\$7.34	DP 125SS304	\$5.94
1-1/2"	DP 150IAL	\$3.00	DP 150IBR	\$8.45	DP 150SS	\$9.42	DP 150SS304	\$8.49
2"	DP 200IAL	\$3.66	DP 200IBR	\$12.08	DP 200SS	\$14.30	DP 200SS304	\$12.51
2-1/2"	DP 250IAL	\$5.19	DP 250IBR	\$16.34	DP 250SS	\$19.02	DP 250SS304	\$16.94
3"	DP 300IAL	\$5.85	DP 300IBR	\$21.23	DP 300SS	\$26.13	DP 300SS304	\$23.21
4"	DP 400IAL	\$8.49	DP 400IBR	\$32.83	DP 400SS	\$36.53	DP 400SS304	\$32.55
5"	DP 500ASTMAL	\$15.98	DP 500ASTMBR	\$51.70	DP 500SS	\$77.26	DP 500SS304	\$61.98
6"	DP 600IAL	\$18.21	DP 600IBR	\$77.11	DP 600SS	\$109.36	DP 600SS304	\$96.06
8"	DP 800IALNAE	\$99.17	--	--	--	--	--	--
8"	DP 800IALPTK	\$104.83	--	--	--	--	--	--
10"	DP 1000IAL	\$166.30	--	--	--	--	--	--
12"	DP 1200IAL	\$228.91	--	--	--	--	--	--

Size	Plated Iron		Poly		Nyglass	
	Part #	List Price	Part #	List Price	Part #	List Price
3/4"	--	--	DP 075PP	\$0.75	DP 075NG	\$1.08
1"	DP 100CI	\$8.77	DP 100PP	\$0.77	DP 100NG	\$1.38
1-1/4"	--	--	**DP 125PP	\$1.21	**DP 125NG	\$2.43
1-1/2"	DP 150CI	\$5.70	**DP 150PP	\$1.23	**DP 150NG	\$2.53
2"	DP 200CI	\$5.00	DP 200PP	\$2.11	DP 200NG	\$2.83
3"	DP 300CI	\$9.36	DP 300PP	\$2.92	DP 300NG	\$5.58
4"	DP 400CI	\$15.38	DP 400PP	\$5.94	DP 400NG	\$10.94
5"	DP 500CI	\$31.98	--	--	--	--
6"	DP 600CI	\$35.38	--	--	--	--

* Dust Caps and Dust Plugs are not designed for pressure applications.

** Available as: 1-1/4 adapter or coupler X 1-1/4 NPT
Please specify: 1-1/2 adapter or coupler X 1-1/4 NPT
1-1/2 adapter or coupler X 1-1/2 NPT



Seal Fast Self Locking Couplers

B Female Coupler X Male NPT 	Size	Aluminum		Brass		Stainless Steel	
		Part #	List Price	Part #	List Price	Part #	List Price
	1"	B 100ALSK	\$13.23	B 100BRSK	\$28.02	B 100SSK	\$25.94
	1-1/2"	B 150ALSK	\$20.72	B 150BRSK	\$52.57	B 150SSK	\$44.62
	2"	B 200ALSK	\$24.09	B 200BRSK	\$54.47	B 200SSK	\$55.85
	2-1/2"	B 250ALSK	\$26.85	B 250BRSK	\$67.21	B 250SSK	\$72.42
	3"	B 300ALSK	\$30.58	B 300BRSK	\$89.62	B 300SSK	\$89.60
4"	B 400ALSK	\$40.55	B 400BRSK	\$106.40	B 400SSK	\$94.64	

C Female Coupler X Hose Shank 	Size	Aluminum		Brass		Stainless Steel	
		Part #	List Price	Part #	List Price	Part #	List Price
	1"	C 100ALSK	\$14.72	C 100BRSK	\$25.19	C 100SSK	\$28.08
	1-1/2"	C 150ALSK	\$24.91	C 150BRSK	\$60.28	C 150SSK	\$45.02
	2"	C 200ALSK	\$30.04	C 200BRSK	\$53.49	C 200SSK	\$53.17
	2-1/2"	C 250ALSK	\$35.11	C 250BRSK	\$74.83	C 250SSK	\$74.98
	3"	C 300ALSK	\$42.74	C 300BRSK	\$120.09	C 300SSK	\$91.98
4"	C 400ALSK	\$55.85	C 400BRSK	\$125.85	C 400SSK	\$131.98	

D Female Coupler X Female NPT 	Size	Aluminum		Brass		Stainless Steel	
		Part #	List Price	Part #	List Price	Part #	List Price
	1"	C 100ALSK	\$14.15	C 100BRSK	\$43.15	C 100SSK	\$28.09
	1-1/2"	C 150ALSK	\$21.89	C 150BRSK	\$63.36	C 150SSK	\$53.58
	2"	C 200ALSK	\$25.49	C 200BRSK	\$68.23	C 200SSK	\$54.40
	2-1/2"	C 250ALSK	\$30.09	C 250BRSK	\$108.79	C 250SSK	\$79.79
	3"	C 300ALSK	\$31.66	C 300BRSK	\$108.42	C 300SSK	\$93.96
4"	C 400ALSK	\$42.09	C 400BRSK	\$120.26	C 400SSK	\$130.79	

DC Dust Cap Coupler 	Size	Aluminum		Brass		Stainless Steel	
		Part #	List Price	Part #	List Price	Part #	List Price
	1"	DC 100ALSK	\$14.15	DC 100BRSK	\$16.60	DC 100SSK	\$23.02
	1-1/2"	DC 150ALSK	\$21.94	DC 150BRSK	\$47.66	DC 150SSK	\$38.87
	2"	DC 200ALSK	\$25.13	DC 200BRSK	\$51.02	DC 200SSK	\$45.08
	2-1/2"	DC 250ALSK	\$30.08	DC 250BRSK	\$60.09	DC 250SSK	\$53.17
	3"	DC 300ALSK	\$32.04	DC 300BRSK	\$60.02	DC 300SSK	\$72.45
4"	DC 400ALSK	\$41.70	DC 400BRSK	\$87.15	DC 400SSK	\$103.74	

DA DA 3020SSK 3" Coupler x 2" Adapter \$106.79	 DA 3020-1SSK 3" Coupler x 2" Adapter w/ 1/2" Tap \$122.87	DD 	Size	Part #	List Price
			2"	DA 200SSK	\$90.57
			3"	DA 300SSK	\$130.19
			Female X Female Coupler With Auto-Lock Handles		

* **Dust Caps** and **Dust Plugs** are **not** designed for pressure applications.

* With auto-lock handles

Crimp Cam and Groove w/ Interlock

C

Have Interlocking Groove to be Used With Crimp Ferrules



Seal Fast Crimp Cam and Groove couplings are to be used with the Seal Fast Ferrules and Crimps Sleeves on pages 54-57 of this catalog. They are designed with an Interlock System which allows the Ferrule to be permanently attached to the coupling

Size	Aluminum		Brass		316 SS	
	Part #	List Price	Part #	List Price	Part #	List Price
1"	C 100ALC	\$7.96	C 100BRC	\$16.70	C 100SSC	\$16.70
1-1/2"	C 150ALC	\$8.04	C 150BRC	\$25.64	C 150SSC	\$29.23
2"	C 200ALC	\$9.89	C 200BRC	\$33.11	C 200SSC	\$39.98
3"	C 300ALC	\$16.32	C 300BRC	\$68.43	C 300SSC	\$79.23
4"	C 400ALC	\$22.58	C 400BRC	\$94.92	C 400SSC	\$99.91
6"	C 600ALC	\$47.38	C 600BRC	\$193.68	C 600SSC	\$264.13

E

Have Interlocking Groove to be Used With Crimp Ferrules



Seal Fast Crimp Cam and Groove couplings are to be used with the Seal Fast Ferrules and Crimps Sleeves on pages 54-57 of this catalog. They are designed with an Interlock System which allows the Ferrule to be permanently attached to the coupling

Size	Aluminum		Brass		316 SS	
	Part #	List Price	Part #	List Price	Part #	List Price
1"	E 100ALC	\$3.49	E 100BRC	\$12.45	E 100SSC	\$11.98
1-1/2"	E 150ALC	\$4.72	E 150BRC	\$20.38	E 150SSC	\$23.57
2"	E 200ALC	\$6.72	E 200BRC	\$28.30	E 200SSC	\$33.11
3"	E 300ALC	\$10.53	E 300BRC	\$59.55	E 300SSC	\$62.40
4"	E 400ALC	\$16.70	E 400BRC	\$83.74	E 400SSC	\$91.25
6"	E 600ALC	\$36.23	E 600BRC	\$189.04	E 600SSC	\$264.42

Butt Weld To Cam and Groove



Adapter By Socket Weld
316 Stainless

AW

Size	Part #	Bore	List Price
2"	AW 200SSI	2.390"	\$19.42
3"	AW 300SSI	3.530"	\$32.55
4"	AW 400SSI	4.530"	\$48.45



Coupler By Socket Weld
316 Stainless

DW

Size	Part #	Bore	List Price
2"	DW 200SSI	2.390"	\$30.85
3"	DW 300SSI	3.530"	\$55.64
4"	DW 400SSI	4.530"	\$72.19



Seal Fast Cam and Groove

A Female NPT X Male Adapter 	Size	356 T6 Alloy		Brass		Banjo Poly	
		Part #	List Price	Part #	List Price	Part #	List Price
	3/4"	A 075AL	\$2.08	A 075BR	\$5.17	075A PP	\$6.32
	1"	A 100AL	\$2.68	A 100BR	\$6.94	100A PP	\$6.32
	1-1/4"	A 125AL	\$3.21	A 125BR	\$12.30	*125A PP	\$6.32
	1-1/2"	A 150AL	\$3.49	A 150BR	\$16.60	150A PP	\$7.18
	2"	A 200AL	\$4.25	A 200BR	\$21.13	200A PP	\$8.46
	2-1/2"	A 250AL	\$7.25	A 250BR	\$33.75	--	--
	3"	A 300AL	\$7.89	A 300BR	\$38.96	300A PP	\$20.44
	4"	A 400AL	\$14.34	A 400BR	\$63.94	400A PP	\$31.17
5"	A 500AL	\$19.77	A 500BR	\$92.26	--	--	
6"	A 600AL	\$25.62	A 600BR	\$134.34	--	--	

B Female Coupler X Male NPT 	Size	356 T6 Alloy		Brass		Banjo Poly	
		Part #	List Price	Part #	List Price	Part #	List Price
	3/4"	B 075AL	\$4.11	B 075BR	\$11.15	075B PP	\$14.45
	1"	B 100AL	\$5.62	B 100BR	\$11.47	100B PP	\$16.60
	1-1/4"	B 125AL	\$8.91	B 125BR	\$22.28	*125B PP	\$16.60
	1-1/2"	B 150AL	\$9.72	B 150BR	\$29.51	150B PP	\$19.46
	2"	B 200AL	\$11.74	B 200BR	\$37.70	200B PP	\$23.69
	2-1/2"	B 250AL	\$12.64	B 250BR	\$39.87	--	--
	3"	B 300AL	\$18.21	B 300BR	\$70.57	300B PP	\$39.82
	4"	B 400AL	\$24.11	B 400BR	\$83.96	400B PP	\$78.91
5"	B 500AL	\$30.30	B 500BR	\$126.58	--	--	
6"	B 600AL	\$51.32	B 600BR	\$202.60	--	--	

C Female Coupler X Hose Shank 	Size	356 T6 Alloy		Brass		Banjo Poly	
		Part #	List Price	Part #	List Price	Part #	List Price
	3/4"	C 075AL	\$5.06	C 075BR	\$13.91	075C PP	\$14.45
	1"	C 100AL	\$6.62	C 100BR	\$21.98	100C PP	\$16.60
	1-1/4"	C 125AL	\$10.09	C 125BR	\$25.36	*125C PP	\$16.60
	1-1/2"	C 150AL	\$12.08	C 150BR	\$29.34	150C PP	\$19.43
	2"	C 200AL	\$14.74	C 200BR	\$48.96	200C PP	\$23.69
	2-1/2"	C 250AL	\$17.60	C 250BR	\$55.06	--	--
	3"	C 300AL	\$25.77	C 300BR	\$95.94	300C PP	\$39.82
	4"	C 400AL	\$34.49	C 400BR	\$143.79	400C PP	\$78.91
5"	C 500AL	\$44.04	C 500BR	\$157.26	--	--	
6"	C 600AL	\$66.91	C 600BR	\$303.58	--	--	

D Female Coupler X Female NPT 	Size	356 T6 Alloy		Brass		Banjo Poly	
		Part #	List Price	Part #	List Price	Part #	List Price
	3/4"	D 075AL	\$4.45	D 075BR	\$11.96	075D PP	\$14.45
	1"	D 100AL	\$6.06	D 100BR	\$17.43	100D PP	\$16.60
	1-1/4"	D 125AL	\$9.79	D 125BR	\$29.53	*125D PP	\$16.60
	1-1/2"	D 150AL	\$10.40	D 150BR	\$33.19	150D PP	\$19.46
	2"	D 200AL	\$12.64	D 200BR	\$41.79	200D PP	\$23.69
	2-1/2"	D 250AL	\$14.94	D 250BR	\$52.38	--	--
	3"	D 300AL	\$19.66	D 300BR	\$70.66	300D PP	\$39.82
	4"	D 400AL	\$26.38	D 400BR	\$97.38	400D PP	\$78.91
5"	D 500AL	\$33.15	D 500BR	\$137.38	--	--	
6"	D 600AL	\$61.64	D 600BR	\$202.83	--	--	

* Banjo Poly 1-1/4" X 1"

Seal Fast Cam and Groove

E Male Adapter X Hose Shank	Size	356 T6 Alloy		Brass		Banjo Poly	
		Part #	List Price	Part #	List Price	Part #	List Price
	3/4"	E 075AL	\$1.98	E 075BR	\$8.19	075E PP	\$6.82
	1"	E 100AL	\$3.26	E 100BR	\$10.19	100E PP	\$7.57
	1-1/4"	E 125AL	\$4.53	E 125BR	\$15.57	*125E PP	\$7.57
	1-1/2"	E 150AL	\$6.13	E 150BR	\$20.23	150E PP	\$7.60
	2"	E 200AL	\$8.38	E 200BR	\$31.62	200E PP	\$9.98
	2-1/2"	E 250AL	\$11.36	E 250BR	\$45.51	--	--
	3"	E 300AL	\$17.26	E 300BR	\$70.36	300E PP	\$26.18
	4"	E 400AL	\$24.64	E 400BR	\$111.75	400E PP	\$31.17
	5"	E 500AL	\$31.81	E 500BR	\$161.57	--	--
	6"	E 600AL	\$52.13	E 600BR	\$241.70	--	--

F Male Adapter X Male NPT	Size	356 T6 Alloy		Brass		Banjo Poly	
		Part #	List Price	Part #	List Price	Part #	List Price
	3/4"	F 075AL	\$1.91	F 075BR	\$4.98	075F PP	\$6.82
	1"	F 100AL	\$2.92	F 100BR	\$7.98	100F PP	\$7.57
	1-1/4"	F 125AL	\$4.64	F 125BR	\$12.92	*125F PP	\$7.57
	1-1/2"	F 150AL	\$4.98	F 150BR	\$17.53	150F PP	\$7.60
	2"	F 200AL	\$6.62	F 200BR	\$27.77	200F PP	\$9.98
	2-1/2"	F 250AL	\$10.47	F 250BR	\$38.77	--	--
	3"	F 300AL	\$12.92	F 300BR	\$51.34	300F PP	\$26.18
	4"	F 400AL	\$23.47	F 400BR	\$84.57	400F PP	\$31.17
	5"	F 500AL	\$30.49	F 500BR	\$136.53	--	--
	6"	F 600AL	\$47.06	F 600BR	\$181.57	--	--

*DC Dust Cap Coupler	Size	356 T6 Alloy		Brass		Banjo Poly	
		Part #	List Price	Part #	List Price	Part #	List Price
	3/4"	DC 075AL	\$3.92	DC 075BR	\$8.19	075DC PP	\$14.45
	1"	DC 100AL	\$5.40	DC 100BR	\$11.15	100DC PP	\$15.94
	1-1/4"	DC 125AL	\$8.64	DC 125BR	\$18.98	*125DC PP	\$15.94
	1-1/2"	DC 150AL	\$9.60	DC 150BR	\$26.60	150DC PP	\$19.48
	2"	DC 200AL	\$10.62	DC 200BR	\$34.28	200DC PP	\$23.69
	2-1/2"	DC 250AL	\$12.42	DC 250BR	\$40.02	--	--
	3"	DC 300AL	\$17.09	DC 300BR	\$59.68	300DC PP	\$39.82
	4"	DC 400AL	\$23.13	DC 400BR	\$76.75	400DC PP	\$57.56
	5"	DC 500AL	\$26.45	DC 500BR	\$102.47	--	--
	6"	DC 600AL	\$45.64	DC 600BR	\$175.87	--	--

*DP Dust Plug Adapter	Size	356 T6 Alloy		Brass		Banjo Poly	
		Part #	List Price	Part #	List Price	Part #	List Price
	3/4"	DP 075AL	\$1.60	DP 075BR	\$3.94	075DP PP	\$6.82
	1"	DP 100AL	\$1.74	DP 100BR	\$5.98	100DP PP	\$6.57
	1-1/4"	DP 125AL	\$2.85	DP 125BR	\$9.75	*125DP PP	\$6.57
	1-1/2"	DP 150AL	\$3.19	DP 150BR	\$12.60	150DP PP	\$7.34
	2"	DP 200AL	\$4.79	DP 200BR	\$19.23	200DP PP	\$9.80
	2-1/2"	DP 250AL	\$6.66	DP 250BR	\$26.32	--	--
	3"	DP 300AL	\$8.40	DP 300BR	\$34.75	300DP PP	\$20.76
	4"	DP 400AL	\$14.91	DP 400BR	\$60.60	400DP PP	\$24.50
	5"	DP 500AL	\$19.25	DP 500BR	\$92.53	--	--
	6"	DP 600AL	\$30.57	DP 600BR	\$125.89	--	--

* Dust Caps and Dust Plugs are not designed for pressure applications.

**Banjo Poly 1-1/4" X 1"



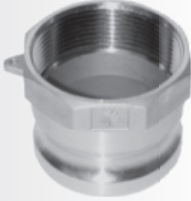

BSP Tapered and Flanged Adapters and Couplers

A Tapered Female BSP X Male Adapter 	Size	Aluminum		316 Stainless Steel	
		Part #	List Price	Part #	List Price
	1-1/2"	A 150IALBSP	\$3.17	150A SSBSP	\$12.81
	2"	A 200IALBSP	\$3.68	200A SSBSP	\$18.68
	3"	A 300IALBSP	\$6.74	300A SSBSP	\$34.25
	4"	A 400IALBSP	\$9.81	400A SSBSP	\$57.74
6"	A 600IALBSP	\$19.91	--	--	

B Tapered Female Coupler X Male BSP 	Size	Aluminum		316 Stainless Steel	
		Part #	List Price	Part #	List Price
	1-1/2"	B 150IALBSP	\$7.40	150B SSBSP	\$20.85
	2"	B 200IALBSP	\$8.00	200B SSBSP	\$28.77
	3"	B 300IALBSP	\$13.11	300B SSBSP	\$52.08
	4"	B 400IALBSP	\$16.89	400B SSBSP	\$67.26
6"	B 600IALBSP	\$35.09	--	--	

D Tapered Female Coupler X Female BSP 	Size	Aluminum		316 Stainless Steel	
		Part #	List Price	Part #	List Price
	1-1/2"	D 150IALBSP	\$7.64	150D SSBSP	\$20.72
	2"	D 200IALBSP	\$8.62	200D SSBSP	\$26.83
	3"	D 300IALBSP	\$13.19	300D SSBSP	\$52.36
	4"	D 400IALBSP	\$19.34	400D SSBSP	\$75.75
6"	D 600IALBSP	\$38.68	--	--	

F Tapered Male Adapter X Male BSP 	Size	Aluminum		316 Stainless Steel	
		Part #	List Price	Part #	List Price
	1-1/2"	F 150IALBSP	\$3.83	150F SSBSP	\$14.43
	2"	F 200IALBSP	\$4.96	200F SSBSP	\$21.62
	3"	F 300IALBSP	\$8.58	300F SSBSP	\$42.75
	4"	F 400IALBSP	\$14.75	400F SSBSP	\$68.87
6"	F 600IALBSP	\$33.02	--	--	

FA 	150# Flanged Adapter 316 SS			FC 	150# Flanged Coupler 316SS		
	Size	Part #	List Price		Size	Part #	List Price
	2"	FA 200SS	\$109.83		2"	FC 200SS	\$142.74
	3"	FA 300SS	\$189.08		3"	FC 300SS	\$251.89
	4"	FA 400SS	\$274.15		4"	FC 400SS	\$309.28
6"	FA 600SS	\$423.83	6"	FC 600SS	\$22.64		

Replacement Handles

All Seal Fast cam arms are supplied complete with pins and spring steel finger rings. All brass, aluminum, and cast iron standard couplers and dust caps are supplied with brass or zinc alloy handles unless otherwise specified. Stainless and poly supplied with stainless steel handle

NOTE: Finger Rings are supplied on Cam Arms of Coupler Sizes 1-1/4" thru 5".

LOCKING CLIPS					Plated Steel SC100 List Price \$				Stainless Steel SC1000SS List Price \$			
Size	Handle, Ring, and Pin				Handle Only				Ring		Pin	
	Brass Part #	List Price	Stainless Part #	List Price	Brass Part #	List Price	Stainless Part #	List Price	Part #	List Price	Part #	List Price
3/4"	HRP 075BR	\$1.11	HRP 075SS	\$1.85	H 075BR	\$0.94	H 075SS	\$1.42	--	--	P 075SS	\$0.25
1"	HRP 100BR	\$1.81	HRP 100SS	\$1.85	H 100BR	\$1.32	H 100SS	\$1.42	R 100	\$0.11	P 100SS	\$0.25
1-1/4"	HRP 200BR	\$2.49	HRP 200SS	\$2.81	H 200BR	\$2.25	H 200SS	\$2.06	R 200	\$0.21	P 200SS	\$0.25
1-1/2"	HRP 200BR	\$2.49	HRP 200SS	\$2.81	H 200BR	\$2.25	H 200SS	\$2.06	R 200	\$0.21	P 200SS	\$0.25
2"	HRP 200BR	\$2.49	HRP 200SS	\$2.81	H 200BR	\$2.25	H 200SS	\$2.06	R 200	\$0.21	P 200SS	\$0.25
2-1/2"	HRP 200BR	\$2.49	HRP 200SS	\$2.81	H 200BR	\$2.25	H 200SS	\$2.06	R 200	\$0.21	P 200SS	\$0.25
3"	HRP 300BR	\$3.26	HRP 300SS	\$3.74	H 300BR	\$2.77	H 300SS	\$2.68	R 300	\$0.30	P 300SS	\$0.60
4"	HRP 400BR	\$3.26	HRP 400SS	\$3.74	H 400BR	\$2.77	H 400SS	\$2.68	R 400	\$0.30	P 300SS	\$0.60
5"	HRP 500BR	\$3.26	HRP 500SS	\$3.74	H 500BR	\$2.77	--	--	R 500	\$0.30	P 300SS	\$0.60
6"	HRP 600BR	\$7.96	HRP 600SS	\$9.91	H 600BR	\$7.08	H 600SS	\$7.45	--	--	P 600PS**	\$1.02
8"	HRP 800BR	\$17.92	--	--	H 800BR	\$17.92	--	--	--	--	P 800PS**	\$1.13



Self Locking Handle			
Size	Part #	List Price	
1"	H100SK	\$5.57	
2"	H200SK	\$9.34	
3"	H300SK	\$9.81	



Replacement Handle for Locking Cap		
Size	Part #	List Price
2"	LH 200SS	\$5.85
3"	LS 300SS	\$6.89
4"	LH 400SS	\$8.49

***NOTE REGARDING GASKETS:** All SFI couplers are supplied with Buna-N as standard. However, this sealing compound may not be compatible with all applications.

STANDARD SIZES AND THREADS The size indicated for a coupler or adapter is the nominal size of pipe or hose to which it connects. Standard sizes for Seal Fast adapters and couplers are 1/2", 3/4", 1", 1-1/4", 1-1/2", 2", 2-1/2", 3", 4", 5", 6" and 8". Threaded parts are furnished with tapered pipe threads (NPT).

DUST CAPS AND DUST PLUGS Dust Caps and Dust Plugs are not designed for pressure application. Caps and Plugs must be chain or cable constrained at all times.

MAXIMUM PRESSURES FOR ALL METALS

1/2"	125 psi
3/4" through 4"	150 psi
5" through 6"	75 psi
8"	20 psi

*Recommendations based on use of mating fittings at ambient temperature of 70° F with standard Buna-N seal installed. For use at elevated temperatures or other unusual operating conditions, consult SFI.

Warning: Working pressure may vary depending on how the couplings are attached to the hose assembly. Before operation, always check the hose assembly for proper attachment and that couplings are in working order.

MAXIMUM PRESSURES FOR BANJO Polypropylene, Import Propylene, and Nyglass

At 0° F	
1/2" through 2"	100 psi
3" through 4"	75 psi

At 70° F	
1/2" through 2"	125 psi
3" through 4"	75 psi

At 150 °F	
1/2" through 2"	70 psi
3" through 4"	75 psi



90° Aluminum Couplers and 45° Couplers



	Female Coupler x Shank				Female Coupler x Male Adapter		
	Size	Part #	List Price		Size	Part #	List Price
	2"	C200AL90	\$18.64		2"	DA200AL90	\$26.87
	3"	C300AL90	\$33.08		3"	DA300AL90	\$44.34
4"	C400AL90	\$46.42	4"	DA400AL90	\$80.00		
C				DA			

	Female Coupler x Shank		
	Size	Part #	List Price
	3"	DA30045AL	\$20.47

Polypropylene 90° Cam and Groove

	Male Adapter x Female NPT				Male Adapter x Female NPT		
	Size	Part #	List Price		Size	Part #	List Price
	1-1/2"	A15090PP	\$5.75		1-1/2"	B15090PP	\$12.45
2"	A20090PP	\$6.47	2"	B20090PP	\$13.34		
A 90°				B 90°			

	Male Adapter x Female NPT				Male Adapter x Female NPT		
	Size	Part #	List Price		Size	Part #	List Price
	1-1/2"	C15090PP	\$10.75		1-1/2"	D15090PP	\$13.75
2"	C20090PP	\$12.74	2"	D20090PP	\$13.58		
C 90°				D 90°			

	Male Adapter x Female NPT				Male Adapter x Female NPT		
	Size	Part #	List Price		Size	Part #	List Price
	1-1/2"	E15090PP	\$4.74		1-1/2"	F15090PP	\$4.74
2"	E20090PP	\$5.15	2"	F20090PP	\$5.15		
E 90°				F 90°			

 <p>CL</p>	Female Coupler x Hose Shank w/ Notched Collar		
	Size	Stainless Steel Part #	List Price
	1-1/2"	150CL SS	\$27.91
	2"	200CL SS	\$39.60
	3"	300CL SS	\$79.15
	4"	400CL SS	\$101.87
Couplings used with Notched Ferrule			

 <p>EL</p>	Male Adapter x Hose Shank w/ Notched Collar		
	Size	Stainless Steel Part #	List Price
	1-1/2"	150EL SS	\$24.51
	2"	200EL SS	\$33.94
	3"	300EL SS	\$66.02
	4"	400EL SS	\$92.46
Couplings used with Notched Ferrule			

Velcro Fasteners for Cam and Groove





Size	Part #	List Price
1" - 1-1/2"	CGS12	\$1.79
2" - 3"	CGS18	\$2.81
4" - 5"	CGS24	\$3.36
6" - 8"	CGS36	\$4.81

Adapters and Reducing Adapters

 <p>SA</p>	Size	Aluminum Part #	List Price	Brass Part #	List Price	Stainless Part #	List Price
	1"	SA 100AL	\$3.30	SA 100BR	\$7.53	100AA SS	\$12.62
	1-1/4"	SA 125AL	\$5.00	SA 125BR	\$13.11	125AA SS	\$29.06
	1-1/2"	SA 150AL	\$6.23	SA 150BR	\$16.32	150AA SS	\$18.58
	1-1/2" x 2"	SA 1520AL	\$5.57	--	--	1520AA SS	\$27.04
	2"	SA 200AL	\$6.75	SA 200BR	\$22.08	200AA SS	\$25.74
	2-1/2"	--	--	--	--	250AA SS	\$44.34
	2" x 3"	SA 2030AL	\$7.51	--	--	2030AA SS	\$43.68
	3"	SA 300AL	\$11.51	SA 300BR	\$37.51	300AA SS	\$42.19
	3" x 4"	SA 3040AL	\$10.66	--	--	3040AA SS	\$69.15
	4"	SA 400AL	\$17.66	SA 400BR	\$64.79	400AA SS	\$70.75
	4" x 6"	SA 4060AL	\$19.53	--	--	4060AA SS	\$144.34
	6"	SA 600AL	\$32.06	--	--	600AA SS	\$150.75

Reducing Adapters and Couplers

 <p>AR</p>	Male Adapter x Female NPT		
	Size	Part #	List Price
	2" x 1-1/2"	AR 2015AL	\$3.75
	2" x 3"	AR 2030AL	\$5.85
	3" x 2"	AR 3020AL	\$6.13
	3" x 4"	AR 3040AL	\$8.87
	4" x 3"	AR 4030AL	\$9.40
	4" x 6"	AR 4060AL	\$17.26
6" x 4"	AR 6040AL	\$17.53	

 <p>BR</p>	Male Adapter x Female NPT		
	Size	Part #	List Price
	1-1/2" x 1"	BR 1510AL	\$7.68
	2" x 1-1/2"	BR 2015AL	\$8.45
	3" x 2"	BR 3020AL	\$12.08
	3" x 4"	BR 3040AL	\$16.51
	4" x 3"	BR 4030AL	\$16.51



Reducing Adapter and Coupler



Spool Adapter With Pipe Tap
AA

Size	Part #	List Price
2" X 2" x 1/2" NPT	200AA-1SS	\$35.57
2" X 2" x 3/4" NPT	200AA-2SS	\$37.42
3" X 3" x 1/2" NPT	300AA-1SS	\$61.57
3" X 3" X 3/4" NPT	300AA-2SS	\$64.91
3" X 3" X 1" NPT	300AA-3SS	\$119.81

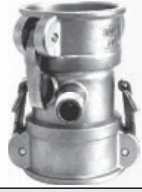

Female Coupler x Female Coupler With Pipe Tap
DD-

Size	Part #	List Price
3" X 3" X 1/2" NPT	300DD-1SS	\$93.40
3" X 3" X 3/4" NPT	300DD-2SS	\$131.72



**Female Coupler x Male Adapter With Pipe Tap
Stainless Steel**
DA-

Size	Part #	List Price
3" x 2" x 1/2" NPT	3020DA-1SS	\$70.75
3" x 2" x 3/4" NPT	3020DA-2SS	\$73.32
3" x 2" x 1" NPT	3020DA-3SS	\$119.96
3" x 3" x 1/2" NPT	3030DA-1SS	\$78.30



**Female Coupler x Female Coupler
Stainless Steel**
DD

Size	Part #	List Price
1-1/2"	150DD SS	\$30.57
2"	200DD SS	\$41.13
2-1/2"	250DD SS	\$83.96
3"	300DD SS	\$64.98
3" x 4"	3040DD SS	\$95.87
4"	400DD SS	\$86.43



Female Coupler x Female NPT
DR

Size	Part #	List Price
1-1/2" x 1"	DR 1510AL	\$7.45
2" x 1-1/2"	DR 2015AL	\$8.40
3" x 2"	DR 3020AL	\$12.26
4" x 3"	DR 4030AL	\$16.04



Female Coupler x Female Coupler
DD

Size	Aluminum Part #	List Price	Brass Part #	List Price
1-1/2"	DD 150AL	\$13.68	--	--
2"	DD 200AL	\$14.64	--	--
3"	DD 300AL	\$21.23	--	--
3" x 2"	DD 3020AL	\$18.11	--	--
3" x 4"	DD 3040AL	\$25.75	--	--
4"	DD 400AL	\$28.08	DD 400BR	\$139.42

Reducing Adapter and Coupler

 <p>DA</p>	Size	Aluminum		Brass		Stainless Steel	
		Part #	List Price	Part #	List Price	Part #	List Price
	1-1/2" x 1"	DA 1510AL	\$9.34	--	--	DA 1510SS	\$25.75
	1-1/2" x 2"	DA 1520AL	\$9.62	--	--	DA 1520SS	\$43.87
	2" x 1 1/2"	DA 2015AL	\$9.53	--	--	DA 2015SS	\$33.64
	2" x 3"	DA 2030AL	\$12.45	--	--	DA 2030SS	\$48.87
	2" x 4"	DA 2040AL	\$16.60	--	--	DA 2040SS	\$123.70
	3" x 1-1/2"	DA 3015AL	\$15.00	--	--	DA 3015SS	\$51.53
	3" x 2"	DA 3020AL	\$15.28	DA 3020BR	\$40.66	DA 3020SS	\$60.28
	3" x 3"	--	--	--	--	DA 3030SS	\$70.57
	3" x 4"	DA 3040AL	\$20.47	DA 3040BR	\$60.34	DA 3040SS	\$87.74
	4" x 2"	DA 4020AL	\$17.74	--	--	DA 4020SS	\$75.85
	4" x 2.5"	--	--	--	--	DA 4025SS	131.13
	4" x 3"	DA 4030AL	\$21.23	DA 4030BR	\$62.74	DA 4030SS	\$82.55
	4" x 6"	DA 4060AL	\$30.64	--	--	DA 4060SS	\$168.13
6" x 4"	DA 6040AL	\$37.06	--	--	DA 6040SS	\$167.42	



316 Stainless Steel Reducer		
Part #	Description	List Price
3020N	3" Female NPSM x 2" Male NPT	\$38.87



316 Stainless Steel Reducer w/ BSP Straight Threads		
Part #	Description	List Price
3020BN	3" Female BSP X 2" Male NPT Stainless	\$38.87
3030BN	3" Female BSP X 3" Male NPT Stainless	\$38.87

Stainless Steel Reducer w/ BSP Straight Threads		
Part #	Description	List Price
3020ALBN	3" Female BSP X 2" Male NPT Aluminum	\$20.89
3030ALBN	3" Female BSP X 3" Male NPT Aluminum	\$23.21

Stainless Steel Pipe Cap		
316 Stainless Steel		
Part #	Description	List Price
PC 300SS	3" Female NPSH Pipe Cap	\$36.79
PC 300SSBSP	3" Stainless Cap w/ BSP Straight Thread	\$36.79
300TG	3" Gasket for Above	\$3.11
HC 300SS	Pipe Cap Hook	\$1.60

Fusible Pipe Cap		
316 Stainless Steel		
Part #	Description	List Price
FC 300SS	3" Female NPSM Fusible Pipe Cap	\$101.62
300TG	3" Gasket for Above	\$3.11

BSPT = British Standard Pipe Threads Tapered or Straight

BSPT = British Standard Pipe Threads Tapered or Straight



Reducing Adapter and Coupler



Size	304 SS Part #	List Price	Size	Brass Part #	List Price
2"	LH 200SS	\$5.85	2"	DCL 200IBR	\$30.75
3"	LH 300SS	\$6.89	3"	DCL 300IBR	\$56.00
4"	LH 400SS	\$8.49	4"	DCL 400IBR	\$69.13

Size	Aluminum Part #	List Price	Size	316 SS Part #	List Price
2"	DCL 200IAL	\$12.92	1.5"	DCL 150SS	\$34.58
3"	DCL 300IAL	\$19.77	2"	DCL 200SS	\$33.79
4"	DCL 400IAL	\$27.92	3"	DCL 300SS	\$43.30
			4"	DCL 400SS	\$99.98

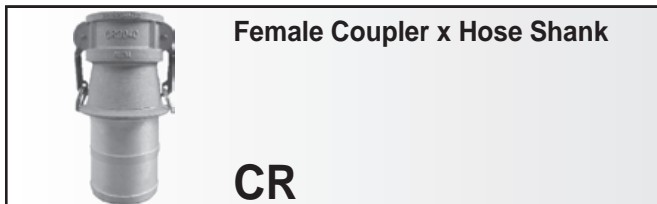

Size	Aluminum Part #	List Price
2" x 1-1/2"	CR 2015AL	\$11.89
3" x 2"	CR 3020AL	\$12.85
3" x 4"	CR 3040AL	\$20.47
4" x 3"	CR 4030AL	\$19.34

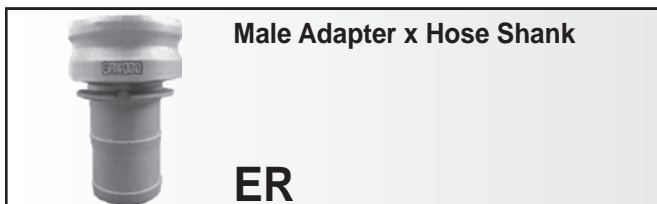

Size	Aluminum Part #	List Price
2" x 1-1/2"	ER 2015AL	\$4.81
2" x 3"	ER 2030AL	\$9.72
3" x 2"	ER 3020AL	\$7.92
3" x 4"	ER 3040AL	\$15.75
4" x 2"	ER 4020AL	\$11.60
4" x 3"	ER 4030AL	\$12.26



Part #	Description	List Price
HA 150AL	1-1/2" Adapter X 1-1/2" NST	\$21.74
HA 250AL	2-1/2" Adapter X 2-1/2" NST	\$23.02

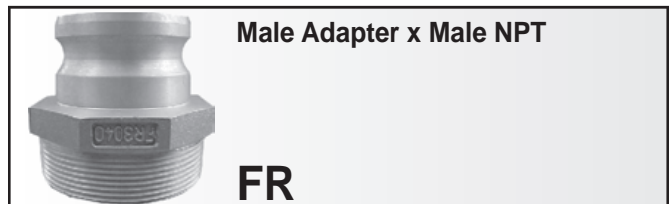

Size	Aluminum Part #	List Price
2" x 1-1/2"	FR 1530AL	\$5.28
2" x 1-1/2"	FR 2015AL	\$5.28
2" x 3"	FR 2030AL	\$7.08
3" x 1-1/2"	FR 3015AL	\$8.68
3" x 2"	FR 3020AL	\$8.40
3" x 4"	FR 3040AL	\$10.66
4" x 2"	FR 4020AL	\$13.38
4" x 3"	FR 4030AL	\$13.58
4" x 6"	FR 4060AL	\$21.89

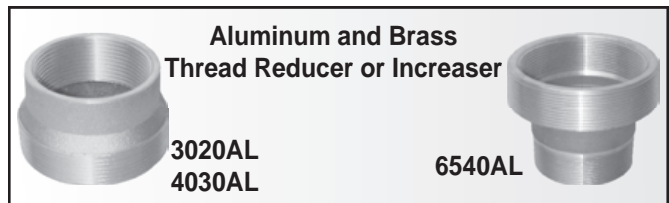

Size	Aluminum Part #	List Price	Brass Part #	List Price
3" NPT-M x 2" NPT-F	3020AL	\$6.26	3020BR	\$17.83
4" NPT-M x 3" NPT-F	4030AL	\$7.51	4030BR	\$26.32
6" NPT-M x 5" NPT-F x 4" NPT-M	6540AL	\$23.11	--	

Replacement Gaskets

The gasket materials listed below comprise a general guide to aid in the selection of the correct seal for customer application.

Buna N: Color **Code Blue**. Buna N is standard. It is generally recommended for petroleum derivatives, neutral or slightly acidic salt solutions, alcohols, ethers, glycols, fats, oils, and greases. This compound should give good service from **-40°F to +250°F**.

Neoprene: Color **Code Red**. Recommended for alkaline and acid salt solutions and aldehydes such as formaldehyde **-65°F to 250°F**.

***Viton A:** All are **Green**. Recommended for aromatics, hydrocarbons, liquid chlorine, carbon disulfide and molten sulfur. Viton A is not recommended for esters or the ketone family. This compound should offer good service **-40°F to 400°F**.

PTFE: The standard PTFE gasket is an envelope type design having a Neoprene Core. PTFE is recommended for highly oxidizing fluids, esters, ketones, and other liquids not generally handled by natural and synthetic rubbers **-40°F to 500°F**.

*PTFE encapsulated with silicon filler

EPDM - Ethylene-propylene rubber -Color **Code White** stripe. Excellent ozone, chemical, and aging resistance. Poor resistance to petroleum-based fluids.

**For use with 800IALPTK 8" cam-lock

Size	Package Qty.	Buna N Part Number	List Price	Buna N Extra Thick Part Number	List Price	Neoprene Part Number	List Price	*Viton-A Part Number	List Price
1/2"	25	050 BN	\$0.17	--	--	050 NE	--	050 VI	\$1.55
3/4"	25	075 BN	\$0.17	--	--	075 NE	\$0.62	075 VI	\$1.77
1"	25	100 BN	\$0.21	--	--	100 NE	\$0.66	100 VI	\$2.15
1-1/4"	25	125 BN	\$0.28	--	--	125 NE	\$0.55	125 VI	\$3.11
1-1/2"	25	150 BN	\$0.32	150 BX	\$0.72	150 NE	\$0.64	150 VI	\$3.49
2"	25	200 BN	\$0.40	200 BX	\$0.79	200 NE	\$0.75	200 VI	\$4.77
2-1/2"	25	250 BN	\$0.53	--	--	250 NE	\$1.00	250 VI	\$5.62
3"	15	300 BN	\$0.58	300 BX	\$1.17	300 NE	\$0.92	300 VI	\$7.26
4"	10	400 BN	\$0.85	400 BX	\$1.49	400 NE	\$1.75	400 VI	\$10.96
5"	--	500 BN	\$1.43	500 BX	\$2.25	500 NE	\$2.02	500 VI	\$20.66
6"	--	600 BN	\$1.45	600 BX	\$3.00	600 NE	\$2.92	600 VI	\$28.02
8"	--	800 BN	\$4.91	--	--	--	--	--	--
8"	--	800 BNPTK*	\$4.91	--	--	--	--	--	--

*For use with 8" PTK style cam lock

Size	Package Qty.	PTFE With Neoprene	List Price	PTFE Envelope with Silicone	List Price	EPDM Part Number	List Price	PTFE Encapsulated Silicon Filler Part #	List Price
3/4"	25	075 TF	\$2.25	--	--	075 EP	\$0.21	--	--
1"	25	100 TF	\$3.94	--	--	100 EP	\$0.28	--	--
1-1/4"	25	125 TF	\$4.75	--	--	125 EP	\$0.36	--	--
1-1/2"	25	150 TF	\$5.17	--	--	150 EP	\$0.45	150 TFCAP	\$18.11
2"	25	200 TF	\$5.58	--	--	200 EP	\$0.47	200 TFCAP	\$18.77
2-1/2"	25	250 TF	\$9.53	--	--	250 EP	\$0.55	250 TFCAP	\$20.38
3"	15	300 TF	\$7.85	300TFS	\$7.85	300 EP	\$1.11	300 TFCAP	\$25.00
4"	10	400 TF	\$11.98	--	--	400 EP	\$1.57	400 TFCAP	\$35.75
5"	--	500 TF	\$19.15	--	--	--	--	--	--
6"	--	600 TF	\$30.87	--	--	--	--	--	--

SPECIAL NOTE REGARDING GASKETS: All SFI couplers are supplied with Buna-N as standard. However, this sealing compound may **not** be compatible with all applications.

* Viton is a trademark of DuPont



Replacement Gaskets*

BUNA-N FDA

The gasket materials listed below comprise a general guide to aid in the selection of the correct seal for customer application.

Buna-N-FDA: Color Code **White**. It is generally recommended for food handling, neutral or slightly acidic salt solutions, alcohols, ethers, glycols, fats, oils, and greases. This compound should give good service from **-40°F to +250°F**.

Size	Package Qty.	Part Number	List Price	Size	Package Qty.	Part Number	List Price
1/2"	-	--	--	2-1/2"	25	250 FDA	\$1.57
3/4"	25	075 FDA	\$0.74	3"	15	300 FDA	\$1.57
1"	25	100 FDA	\$0.94	4"	10	400 FDA	\$2.26
1-1/4"	25	125 FDA	\$0.95	5"	--	500 FDA	\$3.74
1-1/2"	25	150 FDA	\$1.08	6"	--	600 FDA	\$4.72
2"	25	200 FDA	\$1.08	8"	--	--	--

Replacement Gaskets: All **Seal Fast** couplers are supplied with Buna-N as standard. This sealing compound may **not be compatible** with all applications.

The gasket materials listed below comprises a general guide to aid in the selection of the correct seal for customer application. Other factors must also be considered.

Buna-N: Color **code Blue**. Buna-N is standard. It is generally recommended for petroleum derivatives, natural or slightly acidic salt solutions, alcohols, ethers, glycols, fats, oils, and greases. This compound should give good service
From -40°F to +250° F.

Neoprene: Color **code Red**. Recommended for alkaline and acid salt solutions and aldehydes such as formaldehyde -65°F to 250°F.

***Viton A:** Color **code Green**. Recommended for aromatics, hydrocarbons liquid-chlorine, carbon disulfide and molten sulfur. *Viton A is not recommended for esters or the ketone family. This compound should offer good service -40°F to 400°F.

PTFE: The standard PTFE gasket is an envelope type design having a neoprene core. PTFE is recommended for highly oxidizing fluids, esters, ketones, and other liquids not generally handled by natural and synthetic rubbers.

TEMPERATURE RATINGS								
Gasket Material	Temperature Range in °F							
	500	400	300	275	250	200	150	0
Buna N				✓				-40
Neoprene					✓			-65
*Viton A		✓						-40
Silicone	✓							-30
*Teflon	✓							-40
Nat. Rubber						✓		-60
Butyl			✓					-40
Hypalon					✓			-65
EPDM							✓	

*Tetrafluorethylene Resin by DuPont viton & teflon are registered names.



SEAL FAST TANKER PRODUCTS

B

Fuel Tanker Products A.P.I. Openable Adapter, Bottom - Loading & Unloading



106AH

106AH 4" Adapter Openable - Bottom Loading
Heat-treated aluminum construction with a brass ring.
One-piece heavy-duty poppet and stainless steel trim for longer life.
Multi-position short stroke aluminum handle with smooth rotation of less than 60°.
Meets API RP-1004 specifications with a standard 4" TTMA flange.
Viton* seals.



106AHS

106AHS 4" Adapter Openable with Sight Glass - Bottom Loading
— Flat bottom body eliminate product accumulation after unloading.
— Large inside diameter for higher flow rate at 290 gallons per minute.
— Heat treated high strength aluminum one-piece heavy-duty poppet and stainless steel trim for longer life.
— Multi-position short stroke aluminum handle with smooth rotation of less than 60°.
— Meets API RP-1004 specifications with a standard 4" TTMA flange.

U.S. PAT# 5,622,201

Openable Adapter, Bottom-Loading & Unloading A.P.I.		
Size	Part Number	List Price
4"	106AH	\$325.47
4"	106AHS with Sight Glass	\$358.49
4"	RK-106 Repair Kit	\$48.11

*Viton & Teflon are registered trademarks of DuPont Dow Elastomers.



SEAL FAST TANKER PRODUCTS

B

106 API Adapter for Bottom Loading

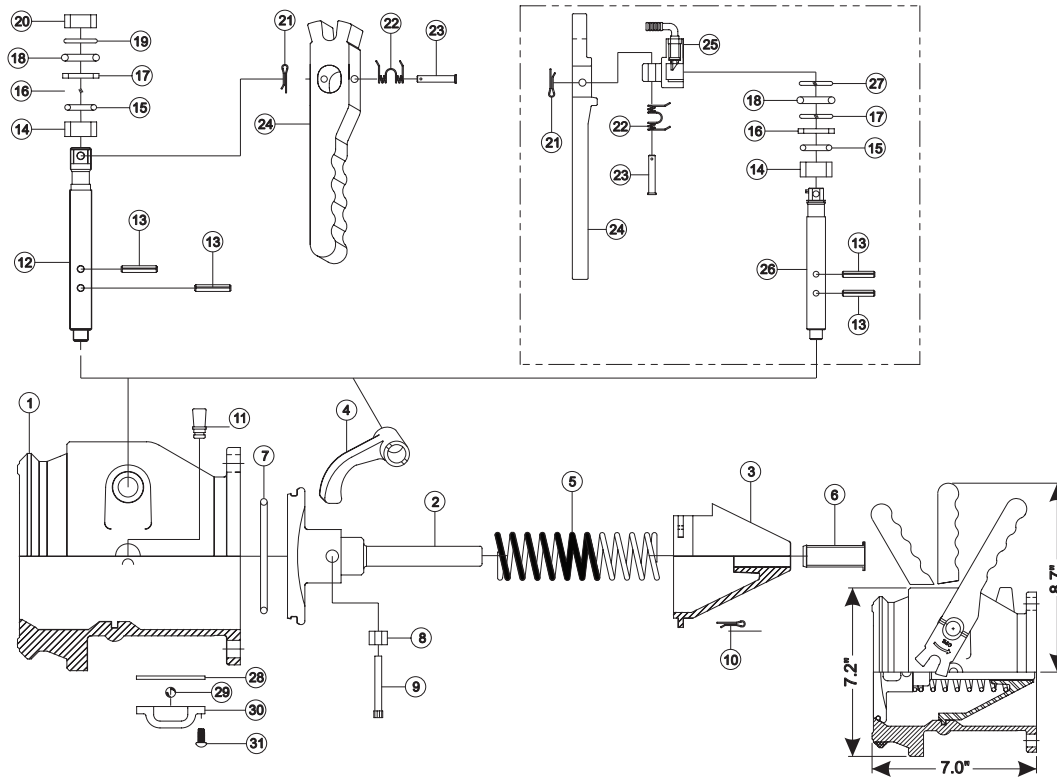

REF No.	DESCRIPTION SIZE	MATERIAL	PART No.	106A Q'ty	106AH Q'ty	106AHS Q'ty
1	BODY w/ BRASS RING	AL/BR	106601	1	1	1
2	POPPET	Aluminum	106602	1	1	1
3	CONE	Aluminum	106603	1	1	1
4	CAM ARM	Stainless	106704		1	1
5	SPRING	Stainless	S40170	1	1	1
6	SLEEVE	PTFE	106805	1	1	1
7*	O-RING	Viton	V0342	1	1	1
8	ROLLER	PTFE	106808		1	1
9	ROLLER PIN	Stainless	P70645		1	1
10	CLIP PIN	Stainless	P16027	2	2	2
11	STUD	Brass	106011		1	1
12	SHAFT	Stainless	106712		1	1
13*	SPRIAL PIN	Stainless	P75028		2	2
14*	BEARING	Nylon	106814		1	1
15*	O-RING	Viton	V0210		1	1
16	SPACER	Stainless	106716		1	1
17*	RETAINING RING	Stainless	IR7025		1	1
18*	O-RING	Buna-N	B0312		1	1
19	WASHER	Stainless	70508		1	1
20	SPACER HOLDER	Stainless	106720		1	1
21	COTTER PIN	Stainless	C2510		1	1
22	SPRING	Stainless	S1233		1	1
23	CLEVIS PIN	Stainless	P76343		1	1
24	HANDLE	Aluminum	106624		1	1
25	SOCKET ASSEMBLY	Stainless	106725			
26	SHAFT HEX HEAD	Stainless	106726			
27	RETAINING RING	Stainless	IS7017			
28	GASKET	Viton	V0120			1
29	FLOAT BALL	PVC	30031			1
30	SIGHT GLASS	Acrylic	30030			1
31	SCREW	Stainless	73705			4
*	REPAIR KIT		RK106	Includes Ref No.: 7, 13, 14, 15, 17 and 18.		

*Viton is a registered trademark of DuPont Dow Elastomers.

Fuel Tanker Products

ACRYLIC SIGHT GLASS TTMA



Solid Acrylic

ASG-400TF

ACRYLIC SIGHT GLASS TTMA

Size	Part Number	List Price
4"	ASG-400TF	\$80.19
CORK GASKET		
4"	C-400TTMA	\$8.49

Features

Construction 1 pcs Solid Acrylic
4" TTMA flange Pattern

Adapter, Loading

106A



A.P.I.

Replaces 1004 AA

Adapter, Bottom-Loading

A. P. I.

Size	Part Number	List Price
4"	106A	\$255.66
Repair Kit	RK-106	\$48.11

Features Of AA Bottom-Loading Valve:

Construction 1 pcs with TTMA 4" flange.
Heat-treated aluminum construction with a brass ring.
Meets API RP-1004 specifications.
Viton* Seals

*Viton is a registered trademarks of DuPont Dow Elastomers.

Gravity, Handle Actuated Coupler

(Use with Part 106A)



A.P.I.

With self locking handles

Gravity, Handle Actuated Coupler

A.P.I.

Size	Part Number	List Price
4" X 4"	1004GH	\$348.85

Features Of Gravity, Handle Actuated Coupler:

- Aluminum alloy construction with self-locking device.
- Meets API RP-1004 specification protects poppet face of API head.
- Cam handle and lug designed for one hand operation.
- Buna-N Gasket standard.
- Interchangeable with competitor's items made to the same specifications.

Pneumatic Air Interlock Valve

A.P.I.



800-PA

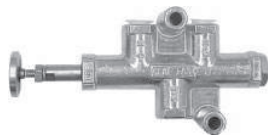

800

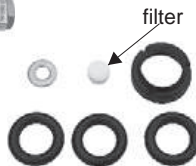

800-RK

Interlock

A. P. I.

Description	Part Number	List Price
Valve	800	\$76.51
Repair Kit (Pad assembly)	800-PA	\$5.28
Repair Kit (Gaskets)	800-RK	\$3.95

Pneumatic Air Interlock Valve:

Brass forged body with all stainless steel components.
*Unique design with filter.
Adjustable contact pad and shaft accommodates competitive API's and other application.
1/4" NPT installs pneumatic connection.
Can be installed as normally closed or open valve.
Can be installed as top side or bottom side (up side down) to connect API's bottom loading adapter or vapor recovery adapter.



SEAL FAST TANKER PRODUCTS

B

Fuel Tanker Products

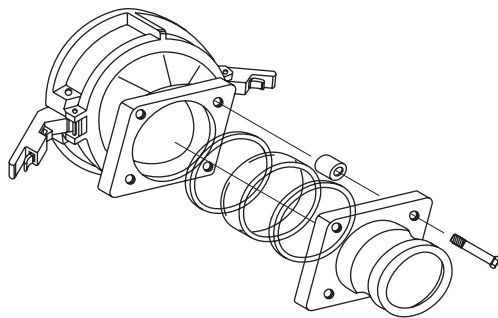

Gravity Drop Two Piece With Sight Glass			
Size	Part Number	Description	List Price
3"	1004GF-300AS	Male Adapter Straight	\$148.11
3"	1004GF-301AS	Male Adapter Off-set	\$155.19
4"	1004GF-400AS	Male Adapter Straight	\$161.02
3"	1004GF-300BLS	Female W / Sight Glass	\$171.68
4"	1004GF-400BLS	Female W / Sight Glass	\$179.62
3"	1004GF-300ASB	Male Threaded W / Sight Glass	\$171.47
4"	1004GF-400ASB	Male Threaded W / Sight Glass	\$180.94
3"	1004GF-300A	Male Adapter W / Out Sight Glass	\$118.58
4"	1004GF-400A	Male Adapter W / Out Sight Glass	\$123.58
3"	1004GF-300BL	Female Coupler W / Out Sight Glass	\$141.21
4"	1004GF-400BL	Female Coupler W / Out Sight Glass	\$147.51
Gravity Drop Two Piece With Sight Glass Parts List			
	1004GF	Flanged Body	\$86.08
	1004SGK	Sight Glass Kit	\$47.96
Adapter And Couplers For Above			
3"	AF-300	Male Adapter Straight	\$28.57
3"	AF-301	Male Adapter Off-Set	\$28.96
4"	AF-400	Male Adapter Straight	\$33.94
3"	BF-300	Female Coupler	\$41.40
4"	BF-400	Female Coupler	\$48.55
3"	BF-300SK	Female Coupler W / Self Locking Handle	\$54.38
4"	BF-400SK	Female Coupler W / Self Locking Handle	\$62.17
3"	MTF-300	Male Threaded	\$28.09
4"	MTF400	Male Threaded	\$33.34
3"	FTF-300	Female Threaded	\$30.77
4"	FTF-400	Female Threaded	\$36.13



FEATURES:

- Orange for Color Coding.
- Ny-glass lockable pull-out handle with stainless steel arms.
- Can be locked from ether side of handle.
- Ability to add safety chains to cap from either side.
- One hand operation to open or close.

Fits 4" Cam & Groove Adapter Also.

Lockable 4" Dust Cap for Vapor Recovery		
Size	Part Number	List Price
4"	840 DC	\$29.91

*Safety chain can be purchased separately.



SEAL FAST TANKER PRODUCTS

B

Fuel Tanker Products

Pneumatic Vapor Valve for 16" and 20" Man Hole Cover

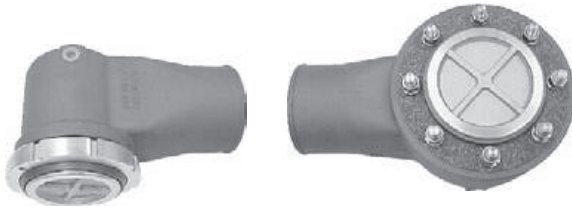

816P 3" Vent

820P 3" Vent

Vapor Valve

A. P. I.

Size	Part Number	List Price
3"	816P	\$239.34
3"	820P	\$252.11
Repair Kit	816P-RK	\$25.47
Repair Kit	820P-RK	\$27.37

Features of 3" Vapor Valve:

- Poppet opens into tank to prevent leakage from surges or from overturned tank. 7.354 square inches of flow area.
- Hard anodized aluminum hood and low profile.
- Tapered seat design with Viton O-ring seal provides leak-tight seal.
- Stainless steel spring, screws, bolts, and nuts resists corrosion.
- 1/4" NPT external pneumatic connection.
- P/N: 820P Installs easily off-set in 20" manhole or separate 3" TTMA size mounting ring.

DC



A.P.I.

Replacement Handle



Not For Pressure Applications

With self locking handle

Dust Cap

A. P. I.

Size	Part Number	List Price
4"	1004DC	\$50.94
Handle	1004CHRK	\$16.98
Gasket	1004DR	\$4.72

Features of API Dust Cap:

- Aluminum alloy construction with self-locking device.
- Meets API RP-1004 specification protects poppet face of API head.
- Nylon-Glass cam handle with **self-locking** feature reduces wear and is non-corrosive.
- Cam handle and lug designed for one hand operation.
- Buna-N gasket standard.
- Interchangeable with competitor's items made to the same specifications.

Gravity Drop Adapter

GA



A.P.I.

With self locking stainless steel handles

Adapter

A. P. I.

Size	Stainless Steel Handles		With Brass Handles	
	Part Number	List Price	Part Number	List Price
4" X 3"	1004GA-300	\$75.47	1004GA-300B	\$65.09
4" X 4"	1004GA-400	\$83.02	1004GA-400B	\$72.64

Features Of Gravity Drop Adapters and Couplers:

- Attach directly against open able API's.
- Allows drop hose with standard Seal Fast cam and groove drop hose with standard Seal Fast cam and groove couplings to clamp on and transfer petroleum from the API valve.
- Meets API RP-1004 specifications.
- Heat treated aluminum alloy.
- With stainless steel **self-locking** handles or brass handles.

GB



A.P.I.

With self locking stainless steel handles

Coupler

A. P. I.

Size	Part Number	List Price
4" X 3"	1004GB-300	\$127.64
4" X 4"	1004GB-400	\$135.00

Gasket



A. P. I.

For gravity drop adapters and couplers.		
Size	Part Number	List Price
4" Gasket	1004GR	\$3.30

Gasket for Seal Fast cam and groove end are standard buna-n cam and groove gaskets.





Fuel Tanker Products

<p>Adapter X 3" Male NPSH with Poppet</p>  <p style="text-align: center;">833F</p> <p style="text-align: center;">Vapor Recovery</p> <table border="1" style="margin-left: auto; margin-right: auto; border-collapse: collapse;"> <thead> <tr> <th>Size</th> <th>Part Number</th> <th>List Price</th> </tr> </thead> <tbody> <tr> <td>3" X 3"</td> <td>833F</td> <td>\$65.85</td> </tr> </tbody> </table>	Size	Part Number	List Price	3" X 3"	833F	\$65.85	<p>CVR *Vapor Recovery Coupler With Probe Also Available W/ Auto Locking Handle</p>  <table border="1" style="margin-left: auto; margin-right: auto; border-collapse: collapse;"> <thead> <tr> <th>Size</th> <th>Aluminum Part Number</th> <th>List Price</th> </tr> </thead> <tbody> <tr> <td>3"</td> <td>CVR 300AL</td> <td>\$33.92</td> </tr> <tr> <td>4"</td> <td>CVR 400AL</td> <td>\$41.47</td> </tr> <tr> <td>4" X 3"</td> <td>CVR4030AL</td> <td>\$42.15</td> </tr> <tr> <td>3"</td> <td>CVR 300ALSK</td> <td>\$59.40</td> </tr> <tr> <td>4"</td> <td>CVR 400ALSK</td> <td>\$67.30</td> </tr> <tr> <td>4" X 3"</td> <td>CVR4030ALSK</td> <td>\$66.62</td> </tr> </tbody> </table>	Size	Aluminum Part Number	List Price	3"	CVR 300AL	\$33.92	4"	CVR 400AL	\$41.47	4" X 3"	CVR4030AL	\$42.15	3"	CVR 300ALSK	\$59.40	4"	CVR 400ALSK	\$67.30	4" X 3"	CVR4030ALSK	\$66.62
Size	Part Number	List Price																										
3" X 3"	833F	\$65.85																										
Size	Aluminum Part Number	List Price																										
3"	CVR 300AL	\$33.92																										
4"	CVR 400AL	\$41.47																										
4" X 3"	CVR4030AL	\$42.15																										
3"	CVR 300ALSK	\$59.40																										
4"	CVR 400ALSK	\$67.30																										
4" X 3"	CVR4030ALSK	\$66.62																										

Features of Adapter X 3" Male NPSH with Poppet:
Vapor adapter popped with 3" Cam & Groove adapter and 3" Male NPSH threads into vapor return when a poppet is required.
Used with CVR Coupler in hose.

Features of Vapor Recovery Coupler with Probe:
CVR can be used with 843A-1, 843A, 844A-1 and 844A

<p>Adapter with Poppet X 3" Female NPSH</p>  <p style="text-align: center;">843A</p> <p style="text-align: center;">Vapor Recovery</p> <p>Features of Adapter with Poppet X 3" Female NPSH: Vapor adapter popped with 4" Cam & Groove and 3" female NPSH Available in hardcoat aluminum</p> <p style="text-align: center;">(Use with Part CVR 400AL or CVR 4030AL)</p>	<p>Adapter with Poppet X 4" Female NPSH</p>  <p style="text-align: center;">844A-1</p> <p style="text-align: center;">Vapor Recovery</p> <p style="text-align: center;">(Use with Part CVR 400AL or CVR 4030AL)</p>																								
Adapter with Poppet X 3" Female NPSH	Adapter with Poppet X 4" Female NPSH																								
<table border="1" style="width: 100%; border-collapse: collapse;"> <thead> <tr> <th>Size</th> <th>Part Number</th> <th>Description</th> <th>List Price</th> </tr> </thead> <tbody> <tr> <td>4" X 3"</td> <td>843A-1</td> <td>Aluminum</td> <td>\$84.62</td> </tr> <tr> <td>4" X 3"</td> <td>843A</td> <td>Hardcoat Aluminum</td> <td>\$88.58</td> </tr> </tbody> </table>	Size	Part Number	Description	List Price	4" X 3"	843A-1	Aluminum	\$84.62	4" X 3"	843A	Hardcoat Aluminum	\$88.58	<table border="1" style="width: 100%; border-collapse: collapse;"> <thead> <tr> <th>Size</th> <th>Part Number</th> <th>Description</th> <th>List Price</th> </tr> </thead> <tbody> <tr> <td>4" X 4"</td> <td>844A-1</td> <td>Aluminum</td> <td>\$85.85</td> </tr> <tr> <td>4" X 4"</td> <td>844A</td> <td>Hardcoat Aluminum</td> <td>\$91.91</td> </tr> </tbody> </table>	Size	Part Number	Description	List Price	4" X 4"	844A-1	Aluminum	\$85.85	4" X 4"	844A	Hardcoat Aluminum	\$91.91
Size	Part Number	Description	List Price																						
4" X 3"	843A-1	Aluminum	\$84.62																						
4" X 3"	843A	Hardcoat Aluminum	\$88.58																						
Size	Part Number	Description	List Price																						
4" X 4"	844A-1	Aluminum	\$85.85																						
4" X 4"	844A	Hardcoat Aluminum	\$91.91																						



SEAL FAST TANKER PRODUCTS

B

818 Vapor Elbow - Dual Point

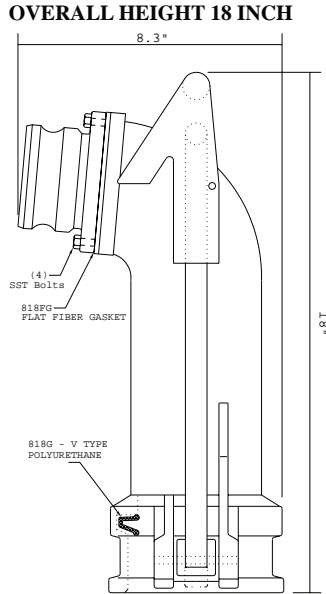

FEATURES:

Push to couple, push and squeeze to release. One piece aluminum alloy construction, easy to operate.

Five degree angled four bolt flange pattern with variety of different outlets to meet any requirement.

Polyurethane V type gasket

Overall height 18"

INLET/OUTLET: Options
SEE PAGE 34

Part Number	Description	List Price
818B	Body Only	\$279.62
818-300A	Outlet AF-300	\$325.34
818-400A	Outlet AF-400	\$333.08
818-300CP	Outlet AF-300CP	\$370.34
818-300BL	Outlet BF-300SL	\$331.98
818-400BL	Outlet BF-400SL	\$335.17
818-300B	Outlet BF-300	\$338.17
818-400B	Outlet BF-400	\$326.79
REPAIR PART		
818FG	Flat Fiber Gasket	\$2.75
818G	V Type Gasket Polyurethane	\$40.38

Swivel Vapor Recovery Adapter - Dual Point

Poppet Assembly Is Integrated With Swivel Top Section

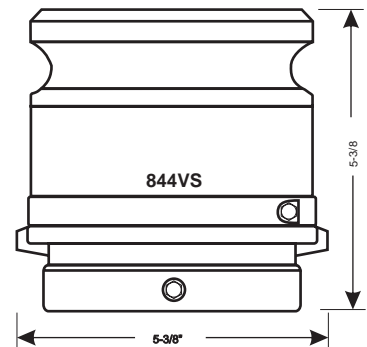
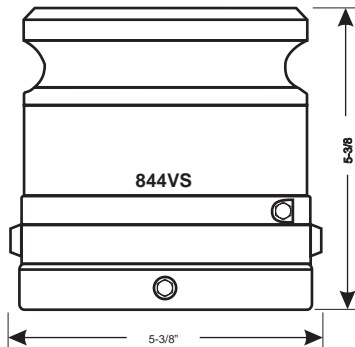

ALUMINUM			BRASS		
Size	Part Number	List Price	Size	Part Number	List Price
4" X 3"	843VSA	\$183.62	4" X 3"	843VSB	\$314.92
4" X 4"	844VSA	\$183.62	4" X 4"	844VSB	\$314.92

Features:

Lower profile design reduces the need to adjust the riser pipe and spill bucket. The swivel top section that rotates 360° with product or vapor elbow movement while the swivel bottom section remains securely sealed to riser pipe. Viton gasket and PTFE-silicone o-ring seals provide compatibility with all current fuels and fuel additives, including the proposed ethanol additive. No lubrication required, complete with stainless steel socket screws. Female thread available with 3" and 4" NPSH to meet all riser pipe requirements.



SEAL FAST TANKER PRODUCTS

B

Vapor Recovery Adapter Poppet Dual Point

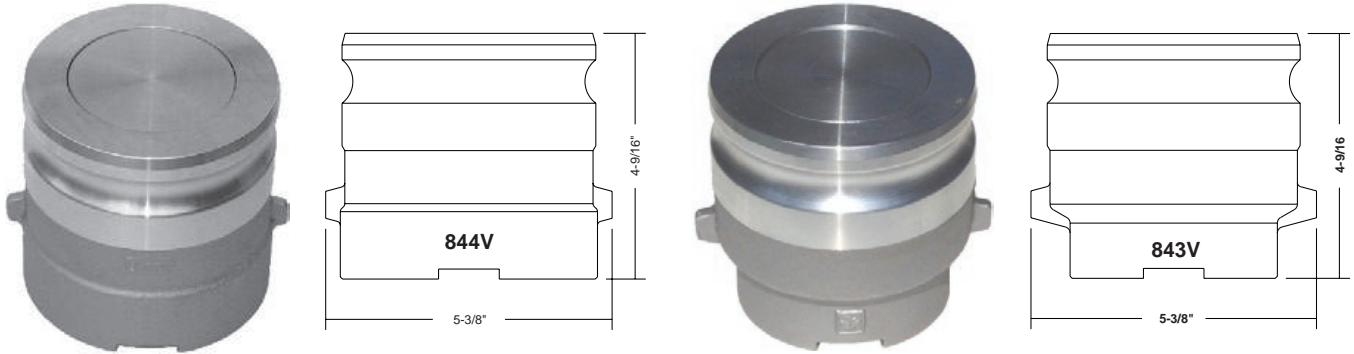

FEMALE THREAD AVAILABLE IN 3" AND 4"

ALUMINUM			BRASS		
Size	Part Number	List Price	Size	Part Number	List Price
4" X 3"	843VA	\$43.00	4" X 3"	843VB	\$68.58
4" X 4"	844VA	\$43.00	4" X 4"	844VB	\$68.58

FEATURES:

- Low profile design overall height 4-9/16".
- Models incorporate dual notches in the base to accept locking clamp.
- Poppeted adapter with stainless spring and stem for corrosion resistance.

Dust Cap's

ORANGE



GRAY

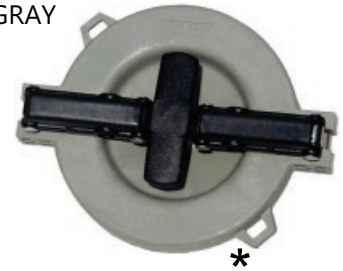

* Safety chain can be purchased separately.
NOT FOR PRESSURE APPLICATIONS

FEATURES

- Orange Color Coding
 - Ny-glass lockable pull out handle with stainless steel arms.
 - Can be locked from either side of handle.
 - Ability to add safety chains to cap from either side.
- One hand operation to open or close.

FEATURES

- Gray Color Coding
 - Ny-glass lockable pull-out handle with stainless steel arms.
 - Can be locked from either side of handle.
 - Ability to add safety chains to cap from either side.
- One hand operation to open or close.

Lockable 4" Dust Cap for Vapor Recovery		
Size	Part Number	List Price
4"	840 DC	\$29.91

Lockable 4" Dust Cap for Fill Adapter's		
Size	Part Number	List Price
4"	940 DC	\$29.91

Replacement Gasket for Dust Cap's		
Size	Part Number	List Price
4"	G-940DC	\$2.28

Wrench

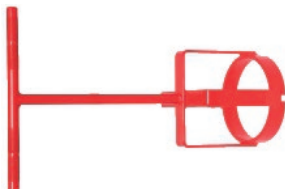

Wrench For Fill Adapters		
Size	Part Number	List Price
16-1/2" x 10 "	WT-890	\$69.55



SEAL FAST TANKER PRODUCTS

B

918 Product Elbow Dual Point "D" Handle

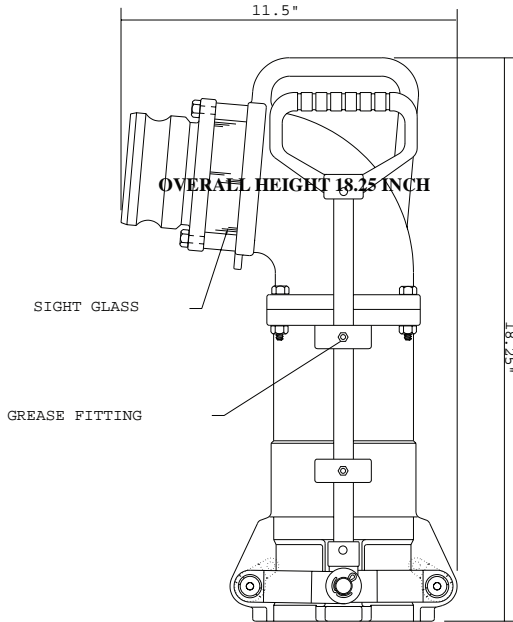

FEATURES:

- Heavy duty aluminum alloy construction, center of gravity at handle, easy to operate.
- Push to couple, pull to release. Unique locking action that insure positive connection and uniform seal compression.
- 360 degree round sight glass window on top.
- 5 degree angled four bolt flange pattern with variety of different inlets to meet any requirement.

OVERALL HEIGHT: 18.25"
WEIGHT: 14.5LB



Part Number	Description	List Price
918 B	Body Only	\$288.68
918-300AS	Inlet AF-300 W/ Sight Glass	\$370.19
918-400AS	Inlet AF-400 W/ Sight Glass	\$350.47
918-300BS	Inlet BF-300 W/ Sight Glass	\$354.15
918-400BS	Inlet BF-400 W/ Sight Glass	\$381.42
918-300BLS	Inlet BF-300sl W/ Sight Glass	\$359.53
918-400BLS	Inlet BF-400sl W/ Sight Glass	\$367.92
918-300MS	Inlet MTF-300 W/ Sight Glass	\$343.96
918-400MS	Inlet MTF-400 W/ Sight Glass	\$343.96
918-300FS	Inlet FTF-300 W/ Sight Glass	\$345.42
918-400FS	Inlet FTF-400 W/ Sight Glass	\$345.42
918-300A	Inlet AF-300 W/O Sight Glass	\$312.64
918-400A	Inlet AF-400 W/O Sight Glass	\$313.02
REPAIR PART		
901G	Gasket Connect Fill Adapter	\$3.40
919G-V	Gasket Connect Fill Adapter Viton*	\$26.85
918SGK	Sight Glass Kit	\$47.96
918NSK	No Sight Glass Kit	\$8.64

*Tetrafluorethylene Resin by DuPont viton & teflon are registered names.

Fill Adapter Top Seal Dual Point

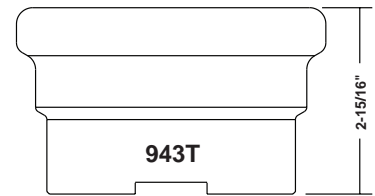
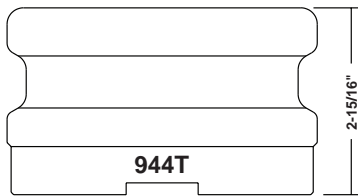

FEMALE THREAD AVAILABLE, 3" AND 4"

ALUMINUM			BRASS		
Size	Part Number	List Price	Size	Part Number	List Price
4" X 3"	943TA	\$41.85	4" X 3"	943TB	\$69.23
4" X 4"	944TA	\$41.85	4" X 4"	944TB	\$69.23

FEATURES:

- Integral internal wrenching lugs.
- Models incorporate dual notches in the base to accept locking clamp.
- Manufactured from durable materials as aluminum alloy and brass.

Standard overall height 2-15/16".



SEAL FAST TANKER PRODUCTS

B

REPAIR PARTS FOR 919 & 918 PRODUCT ELBOWS

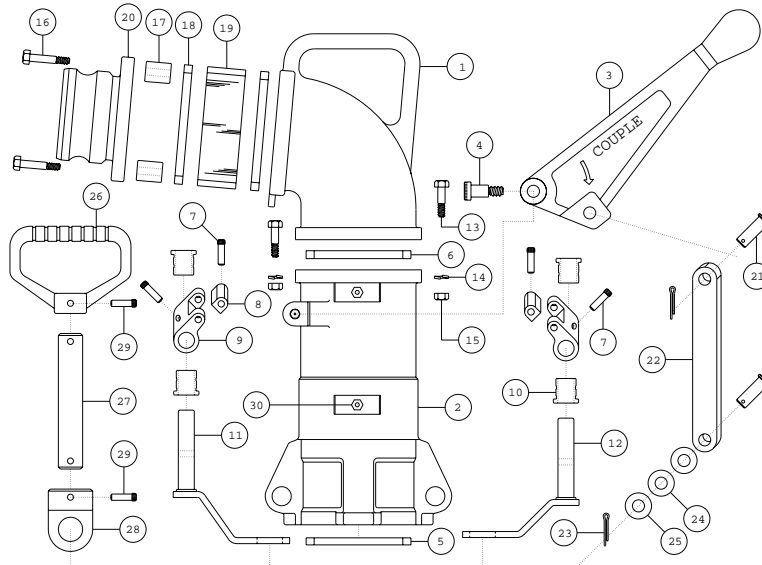

REF. NO.	DESCRIPTION	MATERIAL	PART NO.	QTY.
1	Upper Body	Aluminum	29090	1
2	Lower Body	Aluminum	29019	1
3	Handle	Aluminum	29193	1
4	Shoulder screw	Steel Black	11210	1
5	Gasket Fill Adapter	Buna-N	901G	1
	Gasket Fill Adapter	Viton	901G-V	option
6	Gasket Connect	Buna-N	902G	1
7	Pin	Stainless	76325	4
8	Cam	Stainless	79008	2
9	Cam Arm	Stainless	79009	2
10	Sleeve	Brass	31620	4
11	Left Linkage Arm	Stainless	92211	1
12	Right Linkage Arm	Stainless	92212	1
13	Bolt	Stainless	77938	4
14	Spring Washer	Stainless	77902	4
15	Hex Nut	Stainless	77906	4
16	Bolt	Stainless	77954	4
17	Space Holder	Aluminum	21925	4
18	Gasket	Buna-N	903G	2
19	Sight Glass	Acrylic	900SG	1
20	Inlet Adapter-3A	Aluminum	AF-300AL	1
	Inlet Adapter-4A	Aluminum	AF-400AL	option
	Inlet Coupler-3B	Aluminum	BF-300AL	option
	Inlet Coupler-4B	Aluminum	BF-400AL	option
	Inlet Male Thread-3" NPT	Aluminum	MTF300AL	option
	Inlet Male Thread-4" NPT	Aluminum	MTF400AL	option
21	Clevis Pin	Stainless	71232	2
22	Flat Linkage	Stainless	791911	1
23	Cotter Pin	Stainless	72520	2
24	Waved Washer	Stainless	71204	1
25	Flat Washer	Stainless	71203	2
26	"D" Handle	Aluminum	291802	1
27	Rod	Steele Nickle	191803	1
28	Connector	Stainless	791804	1
29	Pin	Stainless	76332	2
30	Grease Fitting	Brass Nickle	30505	2
31	Sight Glass Repair Kit	Includes 16,17,18,19	918SGK	1



B

919 Product Elbow - Dual Point

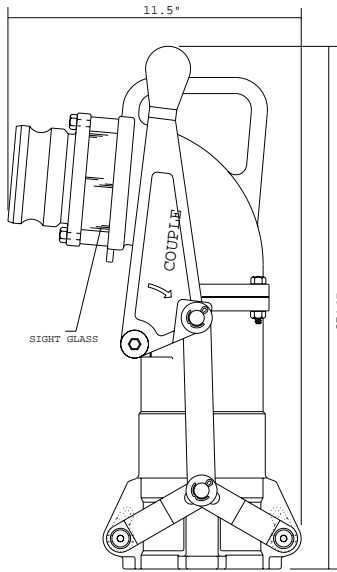

FEATURES:

-
-
-
-

OVERALL HEIGHT 19.25 INCH

Part Number	Description	List Price
919B	Body Only	\$288.68
919-300AS	Inlet AF-300 W/ Sight Glass	\$353.77
919-400AS	Inlet AF-400 W/ Sight Glass	\$335.85
919-300BS	Inlet BF-300 W/ Sight Glass	\$359.43
919-400BS	Inlet BF-400 W/ Sight Glass	\$381.42
919-300BLS	Inlet BF-300sl W/ Sight Glass	\$372.30
919-400BLS	Inlet BF-400sl W/ Sight Glass	\$378.79
919-300MS	Inlet MTF-300 W/ Sight Glass	\$350.58
919-400MS	Inlet MTF-400 W/ Sight Glass	\$355.08
919-300FS	Inlet FTF-300 W/ Sight Glass	\$352.58
919-400FS	Inlet FTF-400 W/ Sight Glass	\$351.77
919-300A	Inlet AF-300 W/O Sight Glass	\$322.17
919-400A	Inlet AF-400 W/O Sight Glass	\$323.08
REPAIR PART		
901G	Gasket to Connect Fill Adapter	\$3.40
919G-V	Gasket to Connect Fill Adapter Viton*	\$26.85
918SGK	Sight Glass Kit	\$47.96
918NSK	No Sight Glass Kit	\$8.64

*VITON is a registered trademark of DuPont Dow Elastomer

Extension Kit For 919 Elbow

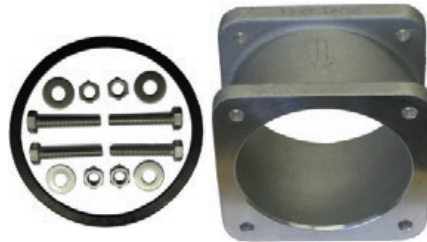

Extension Kit Aluminum		
Size	Part Number	List Price
5" X 5" X 3"	919EK	\$82.00



SEAL FAST TANKER PRODUCTS

B

Coaxial Elbow - Single Point

922 OVERALL HEIGHT 22.4 INCH
926 OVERALL HEIGHT 26 INCH

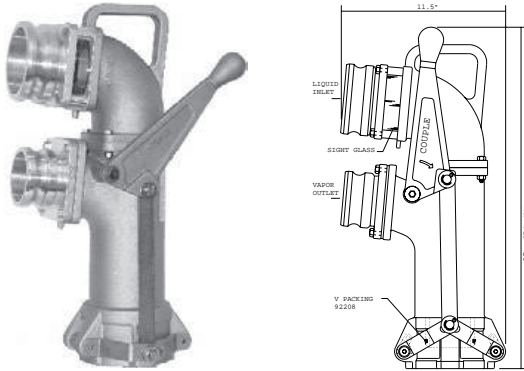

FEATURES:

- Heavy duty aluminum alloy construction.
- Center of gravity at handle for easy operation.
- Unique locking action that insure positive connection and uniform seal compression at fill adapter.
- Product port (liquid inlet) on top and vapor port on bottom to eliminate vapor interference when draining product.
- 360 degree round sight glass on top for easy monitoring.
- 5 degree angled four bolt flange pattern with variety of different inlets and outlets to meet any requirement.
- Coaxial elbows meet stage 1 & 2 vapor recovery standards.

Part Number	Description		List Price
	Inlet Liquid	Outlet Vapor	
922 B	Body		\$415.09
922-4AS-3A	AF-400 W/sight Glass	AF-300	\$536.98
922-4AS-3ACP	AF-400 W/sight Glass	AF-300CP	\$581.89
922-4A-3A	AF-400 W/O Sight Glass	AF-300	\$476.04
922-3AS-3A	AF-300 W/sight Glass	AF-300	\$533.77
922-3AS-3ACP	AF-300 W/sight Glass	AF-300CP	\$576.60
922-3A-3A	AF-300 W/O Sight Glass	AF-300	\$471.74
922-4BLS-3A	BF-400sl W/sight Glass	AF-300	\$530.79
922-4BLS-3ACP	BF-400sl W/sight Glass	AF-300CP	\$584.25
922-4BL-3A	BF-400sl W/O Sight Glass	AF-300	\$500.77
922-4BS-3A	BF-400 W/sight Glass	AF-300	\$519.17
922-4MTS-3A	MtF-400 W/sight Glass	AF-300	\$505.66
922-4MT-3MT	MtF-400 W/O Sight Glass	MTF-300	\$474.74
922-4FTS-3A	FtF-400 W/sight Glass	AF-300	\$507.92
922-4FT-3MT	FtF-400 W/O Sight Glass	MTF-300	\$478.06
Part Number	Description		List Price
	Inlet Liquid	Outlet Vapor	
926 B	Body		\$472.04
926-4AS-3A	AF-400 W/sight Glass	AF-300	\$598.06
926-4AS-3ACP	AF-400 W/sight Glass	AF-300CP	\$645.21
926-4A-3A	AF-400 W/O Sight Glass	AF-300	\$534.91
926-3AS-3A	AF-300 W/sight Glass	AF-300	\$596.04
926-3AS-3ACP	AF-300 W/sight Glass	AF-300CP	\$639.55
926-3A-3A	AF-300 W/O Sight Glass	AF-300	\$534.34
926-4BLS-3A	BF-400sl W/sight Glass	AF-300	\$594.43
926-4BLS-3ACP	BF-400sl W/sight Glass	AF-300CP	\$634.51
926-4BL-3A	BF-400sl W/O Sight Glass	AF-300	\$575.70
926-4BS-3A	BF-400 W/sight Glass	AF-300	\$581.28
926-4MTS-3A	MTF-400 W/sight Glass	AF-300	\$568.40
926-4MT-3MT	MTF-400 W/O Sight Glass	MTF-300	\$537.74
926-4FTS-3A	FTF-400 W/sight Glass	AF-300	\$575.47
926-4FT-3MT	FTF-400 W/O Sight Glass	MTF-300	\$543.66
Repair Parts			
	Description		
92208	V Packing Buna-n (Standard)		\$4.15
92208V	V Packing *Viton		\$38.68
901G	Gasket Connect Fill Adapter		\$3.40
818G	Flat Fiber Gasket For Vapor Only		\$44.62
918SGK	Sight Glass Kit (Bolt, Sight Glass, Gasket)		\$47.96
919NSK	Bolt & Gasket For Inlet W/Out Sight Glass		\$9.92

*VITON is a registered trademark of DuPont Dow Elastomer

Coaxial Adapter Single Point

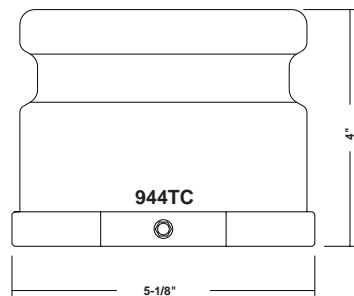

FEATURES:

- Standard overall height 4".
- 944TC coaxial vapor recovery adapter is designed to mate with a coaxial delivery elbow.
- Interchangeable with 633TC.
- Manufactured from durable materials as aluminum. Stainless steel set screw.

Material	Part Number	List Price
ALUMINUM	944TCA	\$43.13



SEAL FAST TANKER PRODUCTS

B

Adapters and Couplers for Products and Vapor Elbows



**CHECK POPPET
AF-300CP**



**ADAPTER STRAIGHT
AF-300**



**ADAPTER OFFSET
AF-301**



**ADAPTER STRAIGHT
AF-400**



**COUPLER
BF-300
(400)**



**COUPLER WITH
SELF LOCKING HANDLES
BF-300SK
(400)**



**MALE THREAD
MTF-300
(400)**



**FEMALE THREAD
FTF-300
(400)**

Part Number	Size	Description	List Price
AF-200	2"	Male Adapter Straight	\$27.40
AF-300CP	3"	Check Poppet Valve	\$75.70
AF-300	3"	Male Adapter Straight	\$28.57
AF-301	3"	Male Adapter Off-Set	\$28.96
AF-400	4"	Male Adapter Straight	\$33.94
BF-300	3"	Female Coupler	\$41.40
BF-400	4"	Female Coupler	\$48.55
BF-300SK	3"	Female Coupler W/ Self Locking SS Handle	\$54.38
BF-400SK	4"	Female Coupler W/ Self Locking SS Handle	\$62.17
MTF-300	3"	Male Threaded	\$28.09
MTF-400	4"	Male Threaded	\$33.34
FTF-300	3"	Female Threaded	\$30.77
FTF-400	4"	Female Threaded	\$36.13



DRY DISCONNECT COUPLINGS

B

Seal Fast Dry - Disconnect Coupling



Not to be used as a shut off valve.
Coupler with self-locking handles
Working pressure:
1-1/2" and 2" at 150 psi
3" at 125 psi

Size Considerations		
Line Size	Dry - Disconnect Adapter or Coupler	Cam & Groove Adapter or Coupler
1-1/2"	1-1/2"	2"
2"	2"	2-1/2"
3"	3"	4"

Adapter X Female NPT			VITON	
Size	Aluminum Viton*	List Price	Stainless Steel Viton*	List Price
1-1/2"	622A-150	\$99.72	672A-150	\$250.53
2"	622A-200	\$109.23	672A-200	\$320.28
3"	622A-300	\$214.81	672A-300	\$585.40

Adapter X Female NPT			PTFE	
Size	Aluminum PTFE	List Price	Stainless Steel PTFE	List Price
1-1/2"	623A-150	\$138.02	673A-150	\$283.96
2"	623A-200	\$158.23	673A-200	\$388.49
3"	623A-300	\$289.83	673A-300	\$621.42

Coupler X Female NPT			VITON	
Size	Aluminum Viton*	List Price	Stainless Steel Viton	List Price
1-1/2"	762D-150	\$269.72	772D-150	\$473.17
2"	762D-200	\$276.42	772D-200	\$488.58
3"	762D-300	\$564.23	772D-300	\$1047.15

Coupler X Female NPT			PTFE	
Size	Aluminum PTFE	List Price	Stainless Steel PTFE	List Price
1-1/2"	763D-150	\$323.58	773D-150	\$518.28
2"	763D-200	\$353.77	773D-200	\$548.42
3"	763D-300	\$774.15	773D-300	\$1273.89

Repair Kits **			VITON	
Size	Adaptor Viton*	List Price	Coupler Viton*	List Price
1-1/2"	RK 150AV	\$10.28	RK 150DV	\$14.34
2"	RK 200AV	\$10.28	RK 200DV	\$14.34
3"	RK 300AV	\$40.57	RK 300DV	\$55.86

Repair Kits **			PTFE	
Size	Adaptor PTFE	List Price	Coupler PTFE	List Price
1-1/2"	RK 150AT	\$31.98	RK 150DT	\$72.26
2"	RK 200AT	\$31.98	RK 200DT	\$72.26
3"	RK 300AT	\$84.43	RK 300DT	\$110.66

*Viton is a registered trademark of DuPont Dow Elastomers.

**S.F.I. Can not be held responsible for the integrity of field rebuilt products. It is strongly recommended that the procedures outlined in the instructions, supplied with the part, be followed and the part be leak tested before placing it back in service. Instructions also on request.

Safety Clip With Chain	Description	Part Number	List Price
	Steel 6" Security Chain w/Safety Clip	SC 600	\$3.49
	Stainless 6" Security Chain w/Safety Clip (Dry Disconnect)	SC 600SS	\$6.79



DRY DISCONNECT COUPLINGS

B

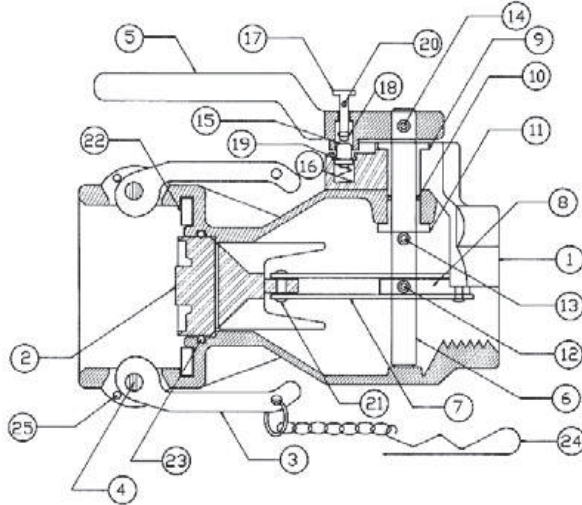

COUPLER PART NUMBERS

KEY	DESCRIPTION	MATERIAL	QTY.	1-1/2" COUPLER	2" COUPLER	3" COUPLER
1	BODY	ALUMINUM A356/T6	1	71501AL	72001AL	73001AL
		STAINLESS STEEL		71501SS	72001SS	73001SS
2	POPPET	ALUMINUM A356/T6	1	71502AL	72002AL	73002AL
		STAINLESS STEEL		71502SS	72002SS	73002SS
3	CAM ARM	STAINLESS STEEL	2	H200SK	H200SK	H300SK
4	CAM PIN	STAINLESS STEEL	2	P200SS	P200SS	P300SS
*5	HANDLE	STAINLESS STEEL		H1205SS	H1205SS	H3405SS
*6	SHAFT	STAINLESS STEEL	1	71206	71206	73006
*7	LINK	STAINLESS STEEL	2	71507	72007	73007
8	CAM	STAINLESS STEEL	1	71508	72008	73008
9	BUSHING	STAINLESS STEEL	1	71209	71209	73009
*10	O-RING	*VITON		R1210V	R1210V	R3010V
		PTFE ENCAP. SILICONE		R1210T	R1210T	R3010T
11	RETAINER	STAINLESS STEEL	1	71211	71211	73411
*12	ROLL PIN	STAINLESS STEEL	1	P4022	P4022	P6032
*13	ROLL PIN	STAINLESS STEEL	1	P4022	P4022	P6032
14	PIN	STAINLESS STEEL	1	P4627	P4627	P4636
**15	STUD	STAINLESS STEEL	1	71215	71215	73015
**16	SPRING	STAINLESS STEEL	1	71216	71216	73016
**17	BUTTON	STAINLESS STEEL	1	71217	71217	73017
**18	C-RING	STAINLESS STEEL	1	71218	71218	73018
**19	HEX NUT	STAINLESS STEEL	1	71219	71219	73019
20	BUTTON HOLE		1			
21	RIVET	STAINLESS STEEL	2	P4719	P4719	P6025
*22	GASKET	*VITON		200VI	250VI	400VI
		PTFE ENCAP. SILICONE		200TFCAP	250TFCAP	400TFCAP
*23	O-RING	*VITON		R1523V	R2023V	R3023V
		PTFE ENCAP. SILICONE		R1523T	R2023T	R3023T
24	SAFETY PIN & CHAIN	STEEL PLATED	1	C1224ST	C1224ST	C3024ST
		STAINLESS STEEL		C1224SS	C1224SS	C3024SS
25	SAFETY PIN	HOLE	2			

* REPAIR KIT: (All Coupler repair kits include a punch)
 **LOCK REPAIR KIT: Part# RK1000 - 1-1/2" & 2" and Part# RK1001 - 3" includes Stud, Spring, Button, C-Ring and Hex Nut

* Viton is a trademark of DuPont



DRY DISCONNECT COUPLINGS

B

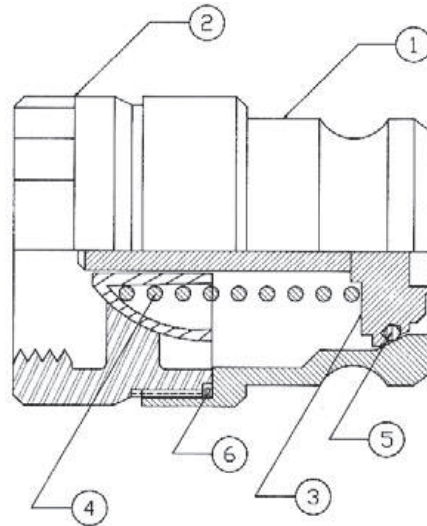

KEY	DESCRIPTION	QTY.	MATERIAL	1-1/2" ADAPTOR	2" ADAPTOR	3" ADAPTOR
1	ADAPTER	1	ALUMINUM A356/T6	61501AL	62001AL	63001AL
			STAINLESS STEEL	61501SS	62001SS	63001SS
2	PIPE END	1	ALUMINUM A356/T6	61502AL	62002AL	63002AL
			STAINLESS STEEL	61502SS	62002SS	63002SS
3	DISC ASSY.	1	ALUMINUM A356/T6	61503AL	62003AL	63003AL
			STAINLESS STEEL	61503SS	62003SS	63003SS
4	SPRING	1	SPRING STEEL	61504ST	62004ST	63004ST
			STAINLESS STEEL	61504SS	62004SS	63004SS
*5	O-RING	1	*VITON	R1505V	R2005V	R3005V
			PTFE ENCAP. SILICONE	R1505T	R2005T	R3005T
*6	O-RING	1	*VITON	R1506V	R2006V	R3006V
			PTFE ENCAP. SILICONE	R1506T	R2006T	R3006T

* RECOMMENDED REPAIR KIT

SEAL FAST DRY- DISCONNECT COUPLING - PRODUCT NO. (ASSEMBLY)

SIZE MATERIAL/SEAL	1-1/2" ADAPTER	1-1/2" COUPLER	2" ADAPTER	2" COUPLER	3" ADAPTER	3" COUPLER
ALUMINUM/*VITON	622A-150	762D-150	622A-200	762D-200	622A-300	762D-300
ALUMINUM/*TEFLON	623A-150	763D-150	623A-200	763D-200	623A-300	762D-300
STAINLESS/VITON	672A-150	772D-150	672A-200	772D-200	672A-300	772D-300
STAINLESS/TEFLON	673A-150	773D-150	673A-200	773D-200	673A-300	773D-300
*VITON	RK-150AV	RK-150DV	RK-200AV	RK-200DV	RK-300AV	RK-300DV
*TEFLON	RK-150AT	RK-150DT	RK-200AT	RK-200DT	RK-300AT	RK-300DT

* MARKS COMPONENTS OF REPAIR KIT

* Viton is a trademark of DuPont



SAFETY CLIPS AND CABLES

B

Security Chains with "S" Hooks

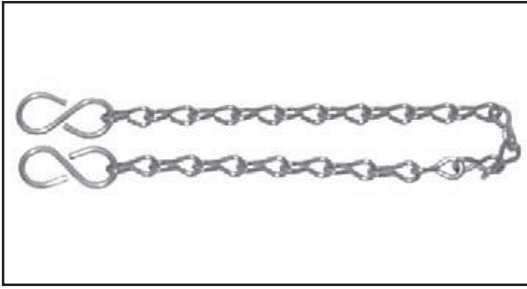

Security chains with two "S" hooks can be used for attaching Dust Plugs and Dust Caps to valves, faucets, or other equipment. Standard chain length is 6" for coupling sizes 3/4" through 2-1/2", 12" for sizes 3" and above.

Description	Part Number	List Price
6" Brass Chain with S-Hook	CH 600BR	\$4.40
12" Brass Chain with S-Hook	CH 1200BR	\$6.26
6" Stainless Chain with S-Hook	CH 600SS	\$1.72
8" Stainless Chain with S-Hook	CH 800SS	\$2.26
12" Stainless Chain with S-Hook	CH 1200SS	\$2.45

Universal Safety Accessories

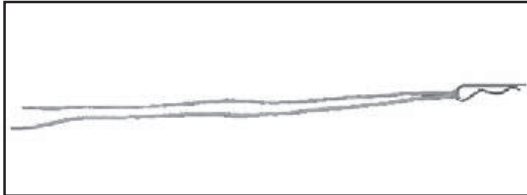

Suggested for use with all Universal Crowfeet and Sandblast Couplings.

Description	Part Number	Pkg. Qty.	List Price Per 100
Safety Clip	SPF 175	100	\$11.04
Safety Lanyard	SPF 176	100	\$11.04

Safety Cable Hose to Hose



Hose to Hose

Can be used in many applications such as Sandblast, Textile and Wire Air hose.

Part Number	Description	Hose Size	List Price
WC 1B	1/8" cable X 20" long	1/2" to 1-1/4"	\$1.98
WC 3B	3/16" cable X 28" long	1/2" to 2"	\$4.06
WC 2B	1/4" cable X 38" long	1-1/2" to 3"	\$5.75
WC 4B	3/8" cable X 44" long	4"	\$15.47
WC 1SS	1/8" cable X 20" long Stainless	1/2" to 1-1/4"	\$13.19
WC 2SS	1/4" cable X 38" long Stainless	1-1/2" to 3"	\$28.02

Safety Cable Hose to Tool

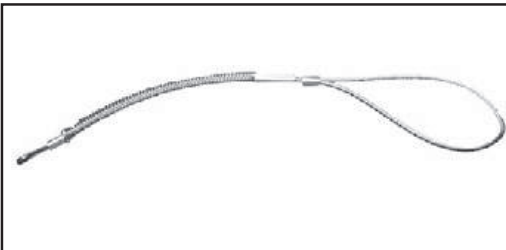

Hose to Tool

Part Number	Description	Hose Size	List Price
WCT 1B	1/8" cable X 20" long	1/2" to 1-1/4"	\$1.92
WCT 3B	3/16" cable X 28" long	1/2" to 2"	\$3.68
WCT 2B	1/4" cable X 38" long	1-1/2" to 3"	\$5.57
WCT 4B	3/8" cable X 44" long	4"	\$16.81

SAFETY CABLE

USE "SAFETY CABLE" TO HELP PREVENT ACCIDENTS OR INJURY RESULTING FROM HOSE OR COUPLING FAILURE.

A positive Safeguard for Air Hose Connections - Helps you Meet Today's Safety Standards. These strong steel cables prevent hose whip in case of accidental separation of coupling or clamp device. "SAFETY CABLE" reaches across the hose fittings to provide standby safety for hose. Spring-loaded loops in the cable ends open easily to pass over the couplings for a firm grip on the hose. "SAFETY CABLE" should be installed in the extended position (no slack). Maximum Working Pressure: 200 psi for Air.





WELD AND T.O.E. NIPPLES

B



Stainless Hex Male Weld Nipples - 316 SS

	Size	Part Number	List Price
	1/8"	FMR 0180B	\$1.53
	1/4"	FMR 0250B	\$1.98
	3/8"	FMR 0375B	\$2.68
	1/2"	FMR 0500B	\$3.30
	3/4"	FMR 0750B	\$3.68
	1"	FMR 1000B	\$6.02
	1-1/4"	FMR 1250B	\$7.17
	1-1/2"	FMR 1500B	\$8.30
	2"	FMR 2000B	\$16.94

Schedule 40 T.O.E. Nipple - Stainless Steel

  <p>Made from schedule 40 pipe.</p>	Size	304SS Part Number	List Price	316SS Part Number	List Price
	1/4" x 2"	T0252-04	\$1.36	T0252-16	\$1.64
	3/8" x 1-1/2"	T03815-04	\$1.34	T03815-16	\$1.62
	3/8" x 2"	T0382-04	\$1.38	T0382-16	\$1.92
	1/2" x 2"	T0502-04	\$1.92	T0502-16	\$2.30
	--	--	--	T075150-16	\$2.68
	3/4" x 2"	T0752-04	\$2.68	T0752-16	\$3.21
	3/4" x 3"	T0753-04	\$3.40	T0753-16	\$4.34
	1" x 2"	T1002-04	\$3.40	T1002-16	\$4.21
	1" x 3"	T1003-04	\$4.62	T1003-16	\$5.83
	1-1/4" x 2"	T1252-04	\$4.62	T1252-16	\$5.83
	1-1/2" x 2"	--	--	T1502-16	\$6.51
	1-1/2" x 2-1/2"	T15025-04	\$6.32	T15025-16	\$7.74
	1-1/2" x 3"	T1503-04	\$7.08	T1503-16	\$9.25
	2" x 2"	T2002-04	\$6.60	T2002-16	\$8.46
	2" x 2-1/2"	T20025-04	\$7.92	T20025-16	\$10.15
	2" x 3"	T2003-04	\$9.53	T2003-16	\$11.89
	2" x 4"	T2004-04	\$11.89	T2004-16	\$15.28
	2" x 6"	T2006-04	\$16.32	T2006-16	\$21.98
	2-1/2" x 3"	T2503-04	\$11.53	T2503-16	\$19.09
3" x 3"	T3003-04	\$19.34	T3003-16	\$26.08	
3" x 4"	T3004-04	\$25.08	T3004-16	\$33.34	
4" x 4"	T4004-04	\$35.47	T4004-16	\$47.36	

Hose Barb - Stainless Steel







1/2 to 1-1/4	1-1/2 to 4	 <p>316 Stainless</p> <p>Not for use with notched ferrule</p> 	Size	Stainless 316	List Price	Size	Stainless 316	List Price
			1/2"	HB 050SSI	\$3.06	2	HB 200SSI	\$23.58
			3/4"	HB 075SSI	\$4.21	2-1/2	HB 250SSI	\$34.83
			1"	HB 100SSI	\$6.89	3	HB 300SSI	\$47.13
			1-1/4"	HB 125SSI	\$8.83	4	HB 400SSI	\$76.75
			1-1/2"	HB 150SSI	\$17.45	6	HB 600SSI	\$181.74



SAND BLAST COUPLINGS

Sandblast Hose Couplings with screws

C

	Hose Ends with Crowfoot								Aluminum & Brass	
	Hose Size	Hose O. D.	Part Number	Aluminum Screws Supplied	List Price	Part Number	Brass Screws Supplied	List Price		
	3/4"	1-1/2"	Q 1AL	4	\$3.77	Q 1BR	4	\$13.87		
	1"	1-7/8"	Q 2AL	4	\$3.94	Q 2BR	4	\$14.77		
	1-1/4"	2-5/32"	Q 3AL	8	\$5.98	Q 3BR	8	\$24.91		
1-1/2"	2-3/8"	Q 4AL	8	\$7.45	Q 4BR	8	\$29.91			
	Hose End Nozzle Holder - NPSH Thread								Aluminum & Brass	
	Hose Size	Hose O. D.	Pipe Thd.	Part Number	Aluminum Screws Supplied	List Price	Part Number	Brass Screws Supplied	List Price	
	3/4"	1-1/2"	1-1/4"	HE 1AL	4	\$3.75	HE 1BR	4	\$12.55	
	1"	1-7/8"	1-1/4"	HE 2AL	4	\$3.77	HE 2BR	4	\$14.49	
	1-1/4"	2-5/32"	1-1/4"	HE 3AL	4	\$5.38	HE 3BR	6	\$21.89	
1-1/2"	2-3/8"	1-1/4"	HE 4AL	4	\$6.32	HE 4BR	8	\$26.98		
	Adapters - Crowfoot x Female NPT Pipe Thread								Aluminum, Brass & Cast Iron	
	Pipe Thd.	Aluminum Part Number	List Price	Brass Part Number	List Price	Cast Iron Part Number	List Price			
	1-1/4"	SB 1AL	\$3.91	SB 1BR	\$15.28	SB 1CI	\$4.91			
	1-1/2"	SB 2AL	\$3.91	SB 2BR	\$14.91	SB 2CI	\$4.91			
Gaskets - Fit All Sizes - 25 per Pkg.						QG	\$0.42			
	Hose Ends with Crowfoot								Nyglass & Cast Iron	
	Hose Size	Hose O. D.	Part Number	Nyglass Screws Supplied	List Price	Part Number	Cast Iron Screws Supplied	List Price		
	3/4"	1-1/2"	Q 1NG	4	\$7.17	Q 1CI	4	\$4.26		
	1"	1-7/8"	Q 2NG	4	\$7.17	Q 2CI	4	\$4.53		
	1-1/4"	2-5/32"	Q 3NG	8	\$10.19	Q 3CI	8	\$7.08		
1-1/2"	2-3/8"	Q 4NG	8	\$12.08	Q 4CI	8	\$9.06			
	Hose End Nozzle Holder - NPSH Thread								Nyglass & Cast Iron	
	Hose Size	Hose O. D.	Pipe Thd.	Part Number	Nyglass Screws Supplied	List Price	Part Number	Cast Iron Screws Supplied	List Price	
	3/4"	1-1/2"	1-1/4"	HE 1NG	4	\$5.85	HE 1CI	4	\$3.96	
	1"	1-7/8"	1-1/4"	HE 2NG	4	\$6.77	HE 2CI	4	\$5.19	
	1-1/4"	2-5/32"	1-1/4"	HE 3NG	8	\$8.49	HE 3CI	8	\$6.51	
1-1/2"	2-3/8"	1-1/4"	HE 4NG	8	\$9.34	HE 4CI	8	\$8.58		
	Gaskets and Screws for Sandblast Couplings									
							Part Number	List Price		
	SBR Gaskets - Fit All Sizes - 25 per Pkg.						QG	\$0.42		
Phillips Head Screws 100 per Package 10 X 5/8 Zinc plated						SCREWS	\$7.21			
 <p>UCG4 SBR UCG2 SBR UCG2EP Red EPDM</p>	Washer for Universal Crowfeet									
					Two Lug		Four Lug			
			Part Number	List Price			Part Number	List Price		
			UCG2	\$0.19			UCG4	\$0.53		
			UCG2EP	\$0.34			--	--		



UNIVERSAL COUPLINGS

Universal Crowfoot Couplings*

For air and water service only. Not to be used for steam service.

Hose End

150psi working pressure @ 70°F when used with Universal Clamps

Size	Zinc Plated Ductile Iron		Brass		Nyglass		Stainless Steel 316	
	Part Number	List Price	Part Number	List Price	Part Number	List Price	Part Number	List Price
1/4"	--	--	--	--	--	--	--	--
3/8"	SFH038	\$1.83	--	--	--	--	--	--
1/2"	SFH050	\$1.81	SFH050B	\$11.51	SFH050NY	\$3.00	SFH050SS	\$11.89
3/4"	SFH075	\$2.32	SFH075B	\$15.00	SFH075NY	\$3.00	SFH075SS	\$11.77
1"	SFH100	\$2.81	SFH100B	\$16.60	SFH100NY	\$3.00	SFH100SS	\$13.55

*Use Safety Clips on page 34 with all Universal Crowfoot Couplings

Female N.P.T. Ends

150psi working pressure @ 70°F when used with Universal Clamps

Size	Zinc Plated Ductile Iron		Brass		Nyglass		Stainless Steel 316	
	Part Number	List Price	Part Number	List Price	Part Number	List Price	Part Number	List Price
1/4"	SFF025	\$2.13	--	--	--	--	--	--
3/8"	SFF038	\$2.09	--	--	--	--	--	--
1/2"	SFF050	\$2.17	SFF050B	\$11.98	SFF050NY	\$3.00	SFF050SS	\$10.66
3/4"	SFF075	\$2.19	SFF075B	\$13.58	SFF075NY	\$3.00	SFF075SS	\$12.11
1"	SFF100	\$2.32	SFF100B	\$15.57	SFF100NY	\$3.00	SFF100SS	\$12.55

*Use Safety Clips on page 34 with all Universal Crowfoot Couplings

Male N.P.T. Ends

150psi working pressure @ 70°F when used with Universal Clamps

Size	Zinc Plated Ductile Iron		Brass		Nyglass		Stainless Steel 316	
	Part Number	List Price	Part Number	List Price	Part Number	List Price	Part Number	List Price
1/4"	SFM025	\$2.13	--	--	--	--	--	--
3/8"	SFM038	\$1.98	--	--	--	--	--	--
1/2"	SFM050	\$2.06	SFM050B	\$12.36	SFM050NY	\$3.00	SFM050SS	\$11.19
3/4"	SFM075	\$2.32	SFM075B	\$14.62	SFM075NY	\$3.00	SFM075SS	\$12.04
1"	SFM100	\$2.40	SFM100B	\$16.42	SFM100NY	\$3.00	SFM100SS	\$13.00

*Use Safety Clips on page 34 with all Universal Crowfoot Couplings

Triple Connection

	Triple Connection	
	Part Number	List Price
	SFTW00 Ductile Iron Zinc Plated	\$4.89
	SFTW00SS Stainless Steel	\$16.32

*Use Safety Clips on page 39 with all Universal Crowfoot Couplings

Blankend

	Blankend	
	Part Number	List Price
	SFBE00 Ductile Iron Zinc plated	\$2.43
	SFBE00SS Stainless Steel	\$9.81





GROUND JOINT COUPLINGS

Four Lug Universal Hose Coupling

For air and water service only. Not to be used for steam service.

Rated for 150 psi at 70°F when used with Universal Clamps





C

 <p>Cast Zinc Plated</p>	Hose Ends			 <p>Cast Zinc Plated</p>	Female N.P.T. Ends		
	Size	Part Number	List Price		Size	Part Number	List Price
	1-1/4"	SFH125	\$7.17		1-1/4"	SFF125	\$6.58
	1-1/2"	SFH150	\$7.92		1-1/2"	SFF150	\$6.58
	2"	SFH200	\$9.98	2"	SFF200	\$7.98	



*Use Safety Clips on page 34 with all Universal Crowfeet Couplings

Ground Joint Swivel Nut Coupling (Zinc Plated)

For use in steam service up to 450°F

 <p>Provided with: Copper or PTFE Seal</p>							 <p>Provided with: Copper or PTFE Seal</p>			
Hose Stem w/Wing-Nut & Female Spud			Hose Stem Only		Swivel Nut		Female Spud Only - (N.P.T.)		Male Pipe Stem Only - (N.P.T.)	
Size	Part Number	List Price	Part Number	List Price	Part Number	List Price	Part Number	List Price	Part Number	List Price
1/4"	SFGJ025	\$12.26	SFGH025H	\$3.11	SFGJ025N	\$3.87	SFGJ025S	\$6.60	SFGJ025MS	\$4.25
3/8"	SFGJ038	\$12.30	SFGJ038H	\$3.06	SFGJ038N	\$3.96	SFGJ038S	\$6.51	SFGJ038MS	\$3.74
1/2"	SFGJ050	\$11.45	SFGJ050H	\$2.92	SFGJ050N	\$4.21	SFGJ050S	\$5.66	SFGJ050MS	\$3.49
1/2" X 3/4"	SFGJ050075	\$12.83	SFGJ050075H	\$3.40	SFGJ050075N	\$4.34	SFGJ050075S	\$7.49	SFGJ050075MS	\$5.09
3/4"	SFGJ075	\$12.74	SFGJ075H	\$3.02	SFGJ075N	\$3.68	SFGJ075S	\$4.91	SFGJ075MS	\$4.98
1"	SFGJ100	\$13.11	SFGJ100H	\$3.58	SFGJ100N	\$3.68	SFGJ100S	\$4.91	SFGJ100MS	\$5.77
1-1/4"	SFGJ125	\$25.00	SFGJ125H	\$6.23	SFGJ125N	\$9.51	SFGJ125S	\$10.57	SFGJ125MS	\$6.23
1-1/2"	SFGJ150	\$25.66	SFGJ150H	\$7.40	SFGJ150N	\$9.43	SFGJ150S	\$10.11	SFGJ150MS	\$8.45
2"	SFGJ200	\$33.02	SFGJ200H	\$8.49	SFGJ200N	\$11.58	SFGJ200S	\$11.23	SFGJ200MS	\$11.98
2-1/2"	SFGJ250	\$72.83	SFGJ250H	\$20.64	SFGJ250N	\$25.75	SFGJ250S	\$32.47	SFGJ250MS	\$20.74
3"	SFGJ300	\$85.94	SFGJ300H	\$28.42	SFGJ300N	\$26.43	SFGJ300S	\$35.81	SFGJ300MS	\$27.08
4"	SFGJ400	\$150.91	SFGJ400H	\$45.66	SFGJ400N	\$53.30	SFGJ400S	\$55.94	SFGJ400MS	\$50.74

Male Spud (Zinc Plated)

 <p>Provided with: Copper or PTFE Seal</p>	Male Spud			 <p>Provided with: Copper or PTFE Seal</p>	Double Male Spud		
	Size	Part Number	List Price		Size	Part Number	List Price
	1/2"	SFGJ050M	\$5.08		1/2"	SFGJ050MM	\$5.45
	3/4"	SFGJ075M	\$7.45		3/4"	SFGJ075MM	\$10.72
	1"	SFGJ100M	\$7.83		1"	SFGJ100MM	\$10.72
	1-1/4"	SFGJ125M	\$12.45		1-1/4"	SFGJ125MM	\$15.38
	1-1/2"	SFGJ150M	\$14.15		1-1/2"	SFGJ150MM	\$15.38
	2"	SFGJ200M	\$17.64		2"	SFGJ200MM	\$20.30
	2-1/2"	SFGJ250M	\$37.72		2-1/2"	SFGJ250MM	\$41.51
	3"	SFGJ300M	\$41.51		3"	SFGJ300MM	\$60.38
4"	SFGJ400M	\$47.17					



HOSE BARB COUPLINGS

Combination Nipples for Straight End Hose

General Uses: Low pressure fluid transfer, suction and discharge.

Working pressures may vary with hose type and clamping system used to install couplings.

Combination Nipples are recommended for low pressure discharge and suction service for compatible liquids.

Not for compressible products such as Air, Nitrogen and Steam.

*All blank end & grooved combination nipples are made using Schedule 40 pipe



								
	Male N.P.T. Unplated		Male N.P.T. Zinc Plated		Male N.P.T. Brass		Male NPT Poly	
Size	Part Number	List Price	Part Number	List Price	Part Number	List Price	Part Number	List Price
1/2"	SF050S	\$1.64	SF050SP	\$1.70	SF050B	\$4.81	SF050PP	\$0.64
3/4"	SF075S	\$1.57	SF075SP	\$1.62	SF075B	\$5.47	SF075PP	\$0.71
1"	SF100S	\$1.85	SF100SP	\$1.87	SF100B	\$6.89	SF100PP	\$1.74
1-1/4"	SF125S	\$2.25	SF125SP	\$2.38	SF125B	\$12.26	SF125PP	\$2.38
1-1/2"	SF150S	\$2.62	SF150SP	\$2.64	SF150B	\$12.55	SF150PP	\$1.60
2"	SF200S	\$3.34	SF200SP	\$3.43	SF200B	\$16.96	SF200PP	\$4.25
2-1/2"	SF250S	\$5.38	SF250SP	\$5.94	SF250B	\$26.79	SF250PP	\$3.00
3"	SF300S	\$6.57	SF300SP	\$7.23	SF300B	\$31.25	SF300PP	\$8.96
4"	SF400S	\$9.53	SF400SP	\$10.91	SF400B	\$73.51	SF400PP	\$8.49
5"	SF500S	\$18.11	SF500SP	\$20.57	--	--	--	--
6"	SF600S	\$29.98	SF600SP	\$33.87	--	--	--	--
8"	SF800S	\$53.77	SF800SP	\$55.81	--	--	--	--
10"	SF1000S	\$86.60	SF1000SP	\$101.25	--	--	--	--
12"	SF1200S	\$124.34	SF1200SP	\$141.13	--	--	--	--

Combination Nipples for Straight End Hose

								
	Male N.P.T. Aluminum		Male N.P.T. 316 Stainless		Male N.P.T. 304 Stainless		Blank End Aluminum	
Size	Part Number	List Price	Part Number	List Price	Part Number	List Price	Part Number	List Price
1/2"	SF050A	\$2.64	SF050SS6	\$4.34	SF050SS	\$3.17	--	--
3/4"	SF075A	\$2.92	SF075SS6	\$4.72	SF075SS	\$3.62	--	--
1"	SF100A	\$2.75	SF100SS6	\$6.98	SF100SS	\$5.09	SF100BA	\$4.25
1-1/4"	SF125A	\$3.57	SF125SS6	\$10.53	SF125SS	\$7.26	SF125BA	\$5.00
1-1/2"	SF150A	\$4.15	SF150SS6	\$12.26	SF150SS	\$8.58	SF150BA	\$5.85
2"	SF200A	\$5.43	SF200SS6	\$17.26	SF200SS	\$11.79	SF200BA	\$8.40
2-1/2"	SF250A	\$7.83	SF250SS6	\$29.25	SF250SS	\$19.81	SF250BA	\$9.81
3"	SF300A	\$10.28	SF300SS6	\$41.23	SF300SS	\$28.21	SF300BA	\$17.51
4"	SF400A	\$17.74	SF400SS6	\$62.09	SF400SS	\$42.83	SF400BA	\$28.17
5"	SF500A	\$25.81	SF500SS6	\$119.25	SF500SS	\$93.58	SF500BA	\$48.30
6"	SF600A	\$39.60	SF600SS6	\$206.79	SF600SS	\$161.62	SF600BA	\$54.04



HOSE BARB COUPLINGS

Combination Nipples for Straight End Hose

General Uses: Low pressure fluid transfer, suction and discharge.
Working pressures may vary with hose type and clamping system used to install couplings.

C

	Blank End Steel		Blank End 316SS 		Grooved Steel Unplated		Grooved 316SS 	
Size	Part Number	List Price	Part Number	List Price	Part Number	List Price	Part Number	List Price
1/2"	SF050SB	\$1.28	--	--	SF050SG	\$1.55	--	--
3/4"	SF075SB	\$1.32	SF075BSS6	\$5.28	SF075SG	\$1.57	--	--
1"	SF100SB	\$1.66	SF100BSS6	\$8.68	SF100SG	\$1.87	SF100SSG6	\$8.49
1-1/4"	SF125SB	\$2.36	SF125BSS6	\$12.94	SF125SG	\$2.57	SF125SSG6	\$12.92
1-1/2"	SF150SB	\$2.74	SF150BSS6	\$16.70	SF150SG	\$2.92	SF150SSG6	\$16.62
2"	SF200SB	\$3.79	SF200BSS6	\$23.87	SF200SG	\$3.96	SF200SSG6	\$24.00
2-1/2"	SF250SB	\$6.23	SF250BSS6	\$38.45	SF250SG	\$6.23	SF250SSG6	\$38.58
3"	SF300SB	\$9.06	SF300BSS6	\$54.91	SF300SG	\$9.53	SF300SSG6	\$55.38
4"	SF400SB	\$15.57	SF400BSS6	\$84.92	SF400SG	\$15.85	SF400SSG6	\$84.19
5"	SF500SB	\$25.15	SF500BSS6	\$166.92	SF500SG	\$25.94	--	--
6"	SF600SB	\$37.66	SF600BSS6	\$188.09	SF600SG	\$38.40	--	--
8"	SF800SB	\$63.96	--	--	SF800SG	\$65.85	--	--
10"	SF1000SB	\$97.68	--	--	SF1000SG	\$147.47	--	--

Combination Nipples

Long Steel Shank Plated Nipples

	 SF125LSP  SF200LSP			
Size	Plated Steel Long Shank	List Price	316SS Long Shank	List Price
1/2"	--	--	--	--
3/4"	--	--	--	--
1"	--	--	--	--
1-1/4"	SF125LSP	\$4.32	SF125LSS6	\$16.75
1-1/2"	SF150LSP	\$4.79	SF150LSS6	\$18.64
2"	SF200LSP	\$6.79	SF200LSS6	\$29.17
2-1/2"	SF250LSP	\$9.83	SF250LSS6	\$42.94
3"	SF300LSP	\$12.51	SF300LSS6	\$57.83
4"	SF400LSP	\$17.09	SF400LSS6	\$72.51
5	--	--	--	--
6	--	--	--	--
8	--	--	--	--



Hex Combo Nipples

				
	Hex Combo Nipples Plain		Hex Combo Nipples Plated	
Size	Part Number	List Price	Part Number	List Price
1/2"	SF050HXS	\$1.57	SF050HXSP	\$1.58
3/4"	SF075HXS	\$1.94	SF075HXSP	\$1.98
1"	SF100HXS	\$2.40	SF100HXSP	\$2.42
1-1/4"	SF125HXS	\$3.15	SF125HXSP	\$3.21



Combination Nipples Reducing and Increasing End Nipples



General Uses: Low pressure fluid transfer, suction and discharge.
Working pressures may vary with hose type and clamping system used to install couplings.

	 Shank X Male thread Jump Sizes Steel		 Shank X Male thread Jump Sizes Steel Plated		 Shank X Male thread Jump Sizes 304 Stainless Steel	
Size	Part Number	List Price	Part Number	List Price	Part Number	List Price
3/4" x 1/2"	SF075050S	\$1.42	SF075050SP	\$1.60	SF075050SS	\$15.94
3/4" x 1"	SF075100S	\$1.53	SF075100SP	\$1.70	SF075100SS	\$17.85
1" x 3/4"	SF100075S	\$1.87	SF100075SP	\$2.08	SF100075SS	\$17.85
1" x 1-1/4"	SF100125S	\$2.11	SF100125SP	\$2.26	SF100125SS	\$27.36
1-1/4" x 1"	SF125100S	\$2.38	SF125100SP	\$2.64	SF125100SS	\$27.36
1-1/4" x 1-1/2"	SF125150S	\$3.09	SF125150SP	\$3.40	SF125150SS	\$31.23
1-1/2" x 1"	SF150100S	\$3.19	SF150100SP	\$3.40	SF150100SS	\$26.85
1-1/2" x 1-1/4"	SF150125S	\$3.11	SF150125SP	\$3.40	SF150125SS	\$30.66
1-1/2" x 2"	SF150200S	\$4.15	SF150200SP	\$4.62	SF150200SS	\$44.64
2" x 1-1/2"	SF200150S	\$4.11	SF200150SP	\$4.62	SF200150SS	\$44.70
2" x 2-1/2"	SF200250S	\$7.23	SF200250SP	\$7.83	SF200250SS	\$59.02
2" x 3"	SF200300S	\$7.26	SF200300SP	\$7.83	SF200300SS	\$70.19
2-1/2" x 2"	SF250200S	\$8.21	SF250200SP	\$9.55	SF250200SS	\$97.49
3" x 2"	SF300200S	\$8.23	SF300200SP	\$9.55	SF300200SS	\$67.60





C

Crimp Style Combination Nipples

General Uses: Low pressure fluid transfer, suction and discharge.
 Working pressures may vary with hose type and clamping system used to install couplings.
 *All Crimp Style Combination Nipples are made using Schedule 40 pipe

				
Crimp Style KC Plated Steel			Crimp Style KC 316 Stainless Steel	
Size	Part Number	List Price	Part Number	List Price
1"	SF100SPC	\$3.40	SF100SS6C	\$12.92
1-1/2"	SF150SPC	\$5.21	SF150SS6C	\$22.55
2"	SF200SPC	\$7.45	SF200SS6C	\$34.40
3"	SF300SPC	\$18.77	SF300SS6C	\$92.36
4"	SF400SPC	\$25.75	SF400SS6C	\$129.89
6"	SF600SPC	\$69.58	SF600SS6C	\$355.28

Crimp Style Combination Nipples



								
	Crimp Style KC Grooved End Steel		Crimp Style KC Grooved 316 Stainless Steel		Crimp Style KC Blank End Steel		Crimp Style KC Blank End 316 Stainless Steel	
Size	Part Number	List Price	Part Number	List Price	Part Number	List Price	Part Number	List Price
1"	SF100SGC	\$2.92	SF100SSG6C	\$13.34	SF100SBC	\$2.74	SF100SSB6C	\$12.45
1-1/2"	SF150SGC	\$4.57	SF150SSG6C	\$25.00	SF150SBC	\$3.83	SF150SSB6C	\$21.60
2"	SF200SGC	\$6.70	SF200SSG6C	\$36.64	SF200SBC	\$5.75	SF200SSB6C	\$33.83
3"	SF300SGC	\$16.15	SF300SSG6C	\$91.51	SF300SBC	\$14.11	SF300SSB6C	\$91.08
4"	SF400SGC	\$22.26	SF400SSG6C	\$131.81	SF400SBC	\$20.00	SF400SSB6C	\$128.79
6"	SF600SGC	\$58.77	SF600SSG6C	\$359.87	SF600SBC	\$54.42	SF600SSB6C	\$357.53

Seal Fast Crimp Combination Nipples are to be used with the Seal Fast Ferrules and Crimps Sleeves on pages 54-57 of this catalog. They are designed with an Interlock System which allows the Ferrule to be permanently attached to the coupling



HOSE BARB COUPLINGS

Hose Barb - 316 SS

 316 Stainless 	1/2 to 1 1/4	1 1/2 to 4	Size	Stainless 316 Investment Cast	List Price	Size	Stainless 316 Investment Cast	List Price
			1/2"	HB 050SSI	\$3.06	2"	HB 200SSI	\$23.58
			3/4"	HB 075SSI	\$4.21	2-1/2"	HB 250SSI	\$34.83
			1"	HB 100SSI	\$6.89	3"	HB 300SSI	\$47.13
			1-1/4"	HB 125SSI	\$8.83	4"	HB 400SSI	\$76.75
			1-1/2"	HB 150SSI	\$17.45	6"	HB 600SSI	\$181.74

*Not for use with Notched Ferrule



Notched Ferrules 304SS

Hose Barb (With Notched Collar)

 316 Stainless	Size	Stainless 316 Investment cast	List Price		Part Number	Hose OD From/To	List Price
	1-1/2"	SFHN150SS	\$17.32		NF1501SS	1.937" - 2.187"	\$9.17
	2"	SFHN200SS	\$24.17		NF1502SS	2.062" - 2.344"	\$9.17
	2-1/2"	SFHN250SS	\$34.08		NF2001SS	2.469" - 2.687"	\$8.02
	3"	SFHN300SS	\$47.42		NF2002SS	2.656" - 2.844"	\$8.21
	4"	SFHN400SS	\$83.83		NF2501SS	3.062" - 3.250"	\$12.64
				NF3001SS	3.469" - 3.719"	\$16.40	
				NF3002SS	3.734" - 3.844"	\$16.94	
				NF4001SS	4.625" - 4.734"	\$28.21	

*For use with Notched Ferrule

Heavy Duty Industrial Hose Stems

 Welded Steel	Hose I.D.	Working Press. psi	Stem ID	Stem Mean OD	Wt Lbs	Cut-off Factor	Male Pipe Part #	List Price	Weld Bevel Part #	List Price	Groove Stem Part #	List Price
	1-1/2"	800	1-1/4"	1-1/2"	1	2-5/8"	HD150NPT	\$6.13	-	--	-	--
	2"	800	1-3/4"	2"	1.5	3"	HD200NPT	\$7.92	HD200WB	\$7.36	HD200G	\$7.74
	2-1/2"	800	2-3/16"	2-1/2"	3.0	3-3/8"	HD250NPT	\$12.45	HD250WB	\$11.28	HD250G	\$11.42
	3"	800	2-9/16"	3"	3.6	4"	HD300NPT	\$17.40	HD300WB	\$15.40	HD300G	\$16.23
	4"	500	3-5/8"	4"	6.5	4-1/2"	HD400NPT	\$27.85	HD400WB	\$25.09	HD400G	\$26.79
	5"	500	4-5/8"	5"	11.5	5-1/2"	HD500NPT	\$45.58	HD500WB	\$41.34	HD500G	\$43.64
	6"	500	5-1/2"	6"	17.0	5-5/8"	HD600NPT	\$68.68	HD600WB	\$60.85	HD600G	\$66.81
	8"	300	7-1/2"	8"	26.0	6"	HD800NPT	\$110.94	HD800WB	\$97.92	HD800G	\$106.87

Heavy Duty Industrial Hose Stems 304 SS

 Male Thread x Hose Shank. 304 Stainless Steel	Hose I.D.	Working PSI	Stem I.D.	Stem O.D.	WT Lbs	Cut Off Factor	Part #	List Price	
	1-1/2"	800	1-1/4"	1-1/2"	1	2-5/8"	HD150NPT SS	\$19.57	
	2"	800	1-3/4"	1-3/4"	1.5	3"	HD200NPT SS	\$27.26	
	2-1/2"	800	2-3/16"	2-3/16"	3	3-3/8"	HD250NPT SS	\$46.23	
	3"	800	2-9/16"	2-9/16"	3.6	4"	HD300NPT SS	\$68.28	
	4"	500	3-5/8"	3-5/8"	6.5	4-1/2"	HD400NPT SS	\$103.89	
	Weld Bevel								
	2"	800	1-3/4"	1-3/4"	1.5	3"	HD200WB SS	\$26.21	
	3"	800	2-9/16"	2-9/16"	3.6	4"	HD300WB SS	\$68.23	
4"	500	3-5/8"	3-5/8"	6.5	4-1/2"	HD400WB SS	\$101.79		



NIPPLES AND MENDERS

Steel Thread Reducing Nipple

*Not for use as drilling swage

C



Size	Part Number	List Price
3/4" X 1/2"	SFRN075050S	\$1.98
1" X 3/4"	SFRN100075S	\$2.40
1-1/4" X 1"	SFRN125100S	\$2.70
1-1/2" X 1-1/4"	SFRN150125S	\$3.11
2" X 1-1/2"	SFRN200150S	\$4.15
2-1/2" X 2"	SFRN250200S	\$6.60
3" X 2"	SFRN300200S	\$8.68
3" X 2-1/2"	SFRN300250S	\$9.34
4" X 3"	SFRN400300S	\$14.08

Plated Thread Reducing Nipple

*Not for use as drilling swage



Size	Part Number	List Price
3/4" X 1/2"	SFRN075050SP	\$2.17
1" X 3/4"	SFRN100075SP	\$2.55
1-1/4" X 1"	SFRN125100SP	\$3.02
1-1/2" X 1-1/4"	SFRN150125SP	\$3.32
2" X 1-1/2"	SFRN200150SP	\$4.32
2-1/2" X 2"	SFRN250200SP	\$6.91
3" X 2"	SFRN300200SP	\$8.96
3" X 2-1/2"	SFRN300250SP	\$9.53
4" X 3"	SFRN400300SP	\$14.26

Hose Mender



Plated Carbon Steel



Stainless Steel 304SS

Size	Part Number	List Price	Part Number	List Price
1/4"	SF025M	\$0.66	--	--
3/8"	SF038M	\$1.09	--	--
1/2"	SF050M	\$1.06	SF050MSS	\$2.64
5/8"	SF058M	\$1.08	--	--
3/4"	SF075M	\$1.13	SF075MSS	\$4.25
1"	SF100M	\$1.47	SF100MSS	\$5.94
1-1/4"	SF125M	\$1.98	SF125MSS	\$7.36
1-1/2"	SF150M	\$2.17	SF150MSS	\$8.96
2"	SF200M	\$3.38	SF200MSS	\$15.38
2-1/2"	SF250M	\$5.64	SF250MSS	\$27.17
3"	SF300M	\$7.36	SF300MSS	\$34.43
4"	SF400M	\$11.00	SF400MSS	\$51.62
5"	SF500M	\$18.58	--	--
6"	SF600M	\$30.57	SF600MSS	\$141.92
8"	SF800M	\$54.09	--	--
10"	SF1000M	\$95.85	--	--
12"	SF1200M	\$207.55	--	--



NIPPLES AND MENDERS



Male Hose Nipples (Zinc Plated) Steel



Male Hose Nipples 316 Stainless Steel

Size	Part Number	List Price	Part Number	List Price
1/8" x 1/4"	HN018025	\$0.75	HNSS018025	\$2.83
1/4" x 1/4"	HN025025	\$0.75	HNSS025025	\$2.83
1/4" x 3/8"	HN025038	\$1.00	HNSS025038	\$7.98
1/4" x 1/2"	HN025050	\$1.55	HNSS025050	\$3.47
3/8" x 1/4"	HN038025	\$1.36	HNSS038025	\$4.06
3/8" x 3/8"	HN038038	\$1.25	HNSS038038	\$4.15
3/8" x 1/2"	HN038050	\$1.79	HNSS038050	\$8.26
1/2" x 3/8"	HN050038	\$1.72	HNSS050038	\$8.30
1/2" x 1/2"	HN050050	\$1.81	HNSS050050	\$14.62
1/2" x 3/4"	HN050075	\$3.11	HNSS050075	\$15.06
3/4" x 1/2"	HN075050	\$2.79	HNSS075050	\$15.11
3/4" x 3/4"	HN075075	\$4.13	HNSS075075	\$23.38
3/4" x 1"	HN075100	\$4.96	HNSS075100	\$25.66
1" x 3/4"	HN100075	\$5.00	HNSS100075	\$30.75
1" x 1"	HN100100	\$5.70	HNSS100100	\$30.75

Long Shank Hose Coupling Steel With Hex Swivel Nuts (Zinc Plated) (NPSH Threads)

Hose I.D. & Description	Part Number	List Price
1/2" Steel Long Shank	SLS050	\$9.91
3/4" Steel Long Shank	SLS075	\$12.55
1" Steel Long Shank	SLS100	\$14.43
1-1/4" Cast Iron Long Shank	SLS125C	\$15.09
1-1/2" Cast Iron Long Shank	SLS150C	\$29.72
2" Cast Iron Long Shank	SLS200C	\$40.57

Brass Hose Mender

Part Number	Hose I. D.	List Price
HM-2	1/8"	\$0.53
HM-3	3/16"	\$0.64
HM-4	1/4"	\$0.70
HM-5	5/16"	\$0.96
HM-6	3/8"	\$1.25
HM-8	1/2"	\$1.38
HM-10	5/8"	\$1.96
HM-12	3/4"	\$2.38

Polypropylene Hose Mender

Size	Part Number	List Price
1/2"	HM050	\$1.52
3/4"	HM075	\$1.67
1"	HM100	\$2.04
1-1/4"	HM125	\$2.30
1-1/2"	HM150	\$4.08
2"	HM200	\$5.13
3"	HM300	\$16.01



ANSI B16.5 Carbon and Stainless Flanges forged 150#

C

Lap Joint Carbon Steel

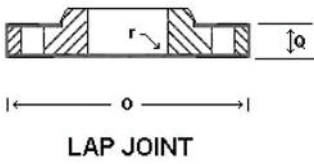
	Part Number	Nominal Pipe Size	Overall Diameter O	Thickness Q	Raised Face Diameter R	Number and Dia. Bolt Holes	Bolt Hole Circle	List Price
	LPJ100	1"	4.25"	0.56"	0.00	4-0.62"	3.12"	\$6.13
LPJ125	1-1/4"	4.62"	0.62"	0.00	4-0.62"	3.50"	\$7.36	
LPJ150	1-1/2"	5.00"	0.68"	0.00	4-0.62"	3.88"	\$9.34	
LPJ200	2"	6.00"	0.75"	0.00	4-0.75"	4.75"	\$13.02	
LPJ250	2-1/2"	7.00"	0.88"	0.00	4-0.75"	5.50"	\$18.96	
LPJ300	3"	7.50"	0.94"	0.00	4-0.75"	6.00"	\$21.38	
LPJ400	4"	9.00"	0.94"	0.00	8-0.75"	7.50"	\$31.60	
LPJ500	5"	10.00"	0.94"	0.00	8-0.88"	8.50"	\$33.85	
LPJ600	6"	1.00"	1.00"	0.00	8-0.88"	9.50"	\$40.00	
LPJ800	8"	13.50"	1.12"	0.00	8-0.88"	1.75"	\$70.83	
LPJ1000	10"	16.00"	1.19"	0.00	12-1.00"	14.25"	\$92.49	
LPJ1200	12"	19.00"	1.25"	0.00	12-1.00"	17.00"	\$163.92	

Lap Joint 316SS

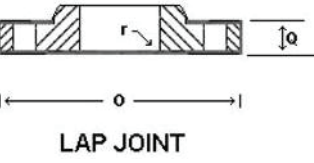
	Part Number	Nominal Pipe Size	Overall Diameter O	Thickness Q	Raised Face Diameter R	Number and Dia. Bolt Holes	Bolt Hole Circle	List Price
	LPJ150SS6	1-1/2"	5.00"	0.68"	0.00	4-0.62"	3.88"	\$39.58
LPJ200SS6	2"	6.00"	0.75"	0.00	4-0.75"	4.75"	\$47.77	
LPJ300SS6	3"	7.50"	0.94"	0.00	4-0.75"	6.00"	\$106.85	
LPJ400SS6	4"	9.00"	0.94"	0.00	4-0.75"	7.50"	\$149.13	
LPJ600SS6	6"	11.00"	1.00"	0.00	8-0.88"	9.50"	\$206.34	

Slip - On Carbon Steel

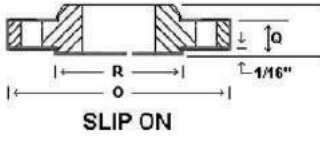
	Part Number	Nominal Pipe Size	Overall Diameter O	Thickness 1/16" Q	Raised Face Diameter R	Number and Dia. Bolt Holes	Bolt Hole Circle	List Price
	SOF100	1"	4.25"	0.56"	2.00"	4-0.62"	3.12"	\$5.98
SOF125	1-1/4"	4.62"	0.62"	2.50"	4-0.62"	3.50"	\$7.08	
SOF150	1-1/2"	5.00"	0.68"	2.88"	4-0.62"	3.88"	\$8.77	
SOF200	2"	6.00"	0.75"	3.62"	4-0.75"	4.75"	\$13.19	
SOF250	2-1/2"	7.00"	0.88"	3.56"	4-0.75"	5.50"	\$18.11	
SOF300	3"	7.50"	0.94"	4.25"	4-0.75"	6.00"	\$19.96	
SOF400	4"	9.00"	0.94"	5.31"	8-0.75"	7.50"	\$25.58	
SOF500	5"	10.00"	0.94"	6.44"	8-0.88"	8.50"	\$32.83	
SOF600	6"	1.00"	1.00"	7.56"	8-0.88"	9.50"	\$38.98	
SOF800	8"	13.50"	1.12"	10.62"	8-0.88"	1.75"	\$70.75	
SOF1000	10"	16.00"	1.19"	12.75"	12-1.00"	14.25"	\$96.04	
SOF1200	12"	19.00"	1.25"	15.00"	12-1.00"	17.00"	\$158.98	

Slip - On 316SS

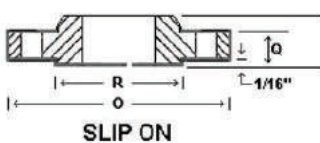
	Part Number	Nominal Pipe Size	Overall Diameter O	Thickness 1/16" Q	Raised Face Diameter R	Number and Dia. Bolt Holes	Bolt Hole Circle	List Price
	SOF150SS6	1-1/2"	5.00"	0.68"	2.88"	4-0.62"	3.88"	\$39.48
SOF200SS6	2"	6.00"	0.75"	2.62"	4-0.75"	4.75"	\$58.87	
SOF300SS6	3"	7.50"	0.94"	4.25"	4-0.75"	6.00"	\$95.19	
SOF400SS6	4"	9.00"	0.94"	5.31"	4-0.75"	7.50"	\$136.28	
SOF600SS6	6"	1.00"	1.00"	7.56"	8-0.88"	9.50"	\$198.19	

ANSI B16.5 Carbon and Stainless Flanges forged 150#

NPT Threaded Carbon Steel

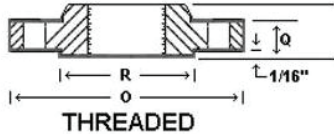
	Part Number	Nominal Pipe Size	Overall Diameter O	Thickness 1/16" Q	Raised Face Diameter R	Number and Dia. Bolt Holes	Bolt Hole Circle	List Price
	NPT100	1"	4.25"	0.56"	2.00"	4-0.62"	3.12"	\$5.64
NPT125	1-1/4"	4.62"	0.62"	2.50"	4-0.62"	3.50"	\$7.51	
NPT150	1-1/2"	5.00"	0.68"	2.88"	4-0.62"	3.88"	\$8.58	
NPT200	2"	6.00"	0.75"	3.62"	4-0.75"	4.75"	\$14.72	
NPT250	2-1/2"	7.00"	0.88"	3.56"	4-0.75"	5.50"	\$19.43	
NPT300	3"	7.50"	0.94"	4.25"	4-0.75"	6.00"	\$23.19	
NPT400	4"	9.00"	0.94"	5.31"	8-0.75"	7.50"	\$27.08	
NPT500	5"	10.00"	0.94"	6.44"	8-0.88"	8.50"	\$35.02	
NPT600	6"	11.00"	1.00"	7.56"	8-0.88"	9.50"	\$45.75	
NPT800	8"	13.50"	1.12"	10.62"	8-0.88"	11.75"	\$72.81	
NPT1000	10"	16.00"	1.19"	12.75"	12-1.00"	14.25"	\$101.28	
NPT1200	12"	19.00"	1.25"	15.00"	12-1.00"	17.00"	\$167.19	

NPT Threaded 316SS

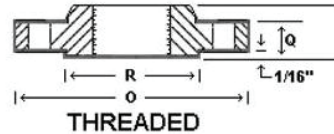
	Part Number	Nominal Pipe Size	Overall Diameter O	Thickness 1/16" Q	Raised Face Diameter R	Number and Dia. Bolt Holes	Bolt Hole Circle	List Price
	NPT150SS6	1-1/2"	5.00"	0.68"	2.88"	4-0.62"	3.88"	\$42.23
NPT200SS6	2"	6.00"	0.75"	2.62"	4-0.75"	4.75"	\$62.87	
NPT300SS6	3"	7.50"	0.94"	4.25"	4-0.75"	6.00"	\$111.62	
NPT400SS6	4"	9.00"	0.94"	5.31"	4-0.75"	7.50"	\$154.53	
NPT600SS6	6"	11.00"	1.00"	7.56"	8-0.88"	9.50"	\$217.45	

Weld Neck Raised Face Carbon Steel

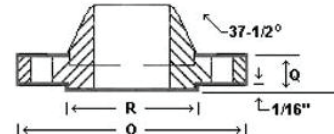
	Part Number	Nominal Pipe Size	Overall Diameter O	Thickness 1/16" Q	Raised Face Diameter R	Number and Dia. Bolt Holes	Bolt Hole Circle	List Price
	WNR100	1"	4.25"	0.56"	2.00"	4-0.62"	3.12"	\$7.83
WNR125	1-1/4"	4.62"	0.62"	2.50"	4-0.62"	3.50"	\$9.55	
WNR150	1-1/2"	5.00"	0.68"	2.88"	4-0.62"	3.88"	\$12.25	
WNR200	2"	6.00"	0.75"	3.62"	4-0.75"	4.75"	\$15.70	
WNR300	3"	7.50"	0.94"	4.25"	4-0.75"	6.00"	\$25.70	
WNR400	4"	9.00"	0.94"	5.31"	8-0.75"	7.50"	\$30.09	
WNR500	5"	10.00"	0.94"	6.44"	8-0.88"	8.50"	\$43.45	
WNR600	6"	11.00"	1.00"	7.56"	8-0.88"	9.50"	\$63.28	
WNR800	8"	13.50"	1.12"	10.62"	8-0.88"	11.75"	\$102.36	
WNR1000	10"	16.00"	1.19"	12.75"	12-1.00"	14.25"	\$146.83	



NIPPLES

Black Steel Nipples



1/2"

3/4"

Part Number	Description	Box Quantity	List Price	Part Number	Description	Box Quantity	List Price Each Steel
NB04001	1/2" X CLOSE	25	\$0.66	NB05001	3/4" X CLOSE	25	\$0.75
NB04015	1/2" X 1-1/2"	25	\$0.66	NB05015	3/4" X 1-1/2"	25	\$0.75
NB04020	1/2" X 2"	25	\$0.72	NB05020	3/4" X 2"	25	\$0.85
NB04025	1/2" X 2-1/2"	25	\$0.79	NB05025	3/4" X 2-1/2"	25	\$0.91
NB04030	1/2" X 3"	25	\$0.85	NB05030	3/4" X 3"	25	\$1.00
NB04035	1/2" X 3-1/2"	25	\$0.91	NB05035	3/4" X 3-1/2"	25	\$1.06
NB04040	1/2" X 4"	25	\$0.94	NB05040	3/4" X 4"	25	\$1.13
NB04045	1/2" X 4-1/2"	25	\$1.00	NB05045	3/4" X 4-1/2"	25	\$1.19
NB04050	1/2" X 5"	25	\$1.09	NB05050	3/4" X 5"	25	\$1.28
NB04055	1/2" X 5-1/2"	25	\$1.15	NB05055	3/4" X 5-1/2"	25	\$1.34
NB04060	1/2" X 6"	25	\$1.19	NB05060	3/4" X 6"	25	\$1.43

1"

1-1/4"

Part Number	Description	Box Quantity	List Price	Part Number	Description	Box Quantity	List Price Each Steel
NB06001	1" X CLOSE	25	\$0.94	NB07001	1-1/4" X CLOSE	25	\$1.09
NB06020	1" X 2"	25	\$1.04	NB07020	1-1/4" X 2"	25	\$1.19
NB06025	1" X 2-1/2"	25	\$1.13	NB07025	1-1/4" X 2-1/2"	25	\$1.32
NB06030	1" X 3"	25	\$1.28	NB07030	1-1/4" X 3"	25	\$1.47
NB06035	1" X 3-1/2"	25	\$1.38	NB07035	1-1/4" X 3-1/2"	25	\$1.62
NB06040	1" X 4"	25	\$1.51	NB07040	1-1/4" X 4"	25	\$1.75
NB06045	1" X 4-1/2"	25	\$1.60	NB07045	1-1/4" X 4-1/2"	25	\$1.94
NB06050	1" X 5"	25	\$1.75	NB07050	1-1/4" X 5"	25	\$2.09
NB06055	1" X 5-1/2"	25	\$1.85	NB07055	1-1/4" X 5-1/2"	--	\$2.23
NB06060	1" X 6"	25	\$1.94	NB07060	1-1/4" X 6"	--	\$2.38

1-1/2"

2"

Part Number	Description	Box Quantity	List Price Each Steel	Part Number	Description	Box Quantity	List Price Each Steel
NB08001	1-1/2" X CLOSE	25	\$1.38	NB09001	2" X CLOSE	25	\$1.75
NB08020	1-1/2" X 2"	25	\$1.42	NB09025	2" X 2-1/2"	25	\$1.84
NB08025	1-1/2" X 2-1/2"	25	\$1.60	NB09030	2" X 3"	25	\$2.08
NB08030	1-1/2" X 3"	25	\$1.75	NB09035	2" X 3-1/2"	--	\$2.26
NB08035	1-1/2" X 3-1/2"	25	\$1.96	NB09040	2" X 4"	--	\$2.50
NB08040	1-1/2" X 4"	25	\$2.13	NB09045	2" X 4-1/2"	--	\$2.69
NB08045	1-1/2" X 4-1/2"	25	\$2.26	NB09050	2" X 5"	--	\$2.92
NB08050	1-1/2" X 5"	25	\$2.45	NB09055	2" X 5-1/2"	--	\$3.16
NB08055	1-1/2" X 5-1/2"	25	\$2.64	NB09060	2" X 6"	--	\$3.40
NB08060	1-1/2" X 6"	25	\$2.78				



NIPPLES



Black Steel Nipples



3"

4"



Part Number	Description	Box Quantity	List Price Each Steel	Part Number	Description	Box Quantity	List Price Each Steel
NB11001	3" X Close	10	\$4.19	NB12001	4" X CLOSE	10	\$4.25
NB11040	3" X 4"	10	\$4.48	NB12040	4" X 4"	10	\$7.45
NB11060	3" X 6"	10	\$5.00	NB12060	4" X 6"	10	\$8.02

Galvanized Steel Nipples

1/2"

3/4"

Part Number	Description	Box Quantity	List Price Each Steel	Part Number	Description	Box Quantity	List Price Each Steel
NG04001	1/2" X CLOSE	25	\$0.66	NG05001	3/4" X CLOSE	25	\$0.81
NG04015	1/2" X 1-1/2"	25	\$0.71	NG05015	3/4" X 1-1/2"	25	\$0.81
NG04025	1/2" X 2-1/2"	25	\$0.85	NG05020	3/4" X 2"	25	\$0.90
NG04030	1/2" X 3"	25	\$0.90	NG05025	3/4" X 2-1/2"	25	\$0.99
NG04045	1/2" X 4-1/2"	25	\$1.13	NG05030	3/4" X 3"	25	\$1.08
				NG05035	3/4" X 3-1/2"	25	\$1.13
				NG05040	3/4" X 4"	25	\$1.23
				NG05050	3/4" X 5"	25	\$1.46
				NG05055	3/4" X 5-1/2"	25	\$1.51

1"

1-1/4"

Part Number	Description	Box Quantity	List Price Each Steel	Part Number	Description	Box Quantity	List Price Each Steel
NG06020	1" X 2"	25	\$1.13	NG07001	1-1/4" X CLOSE	25	\$1.19
NG06030	1" X 3"	25	\$1.37				
NG06040	1" X 4"	25	\$1.65				
NG06055	1" X 5-1/2"	25	\$2.12				

1-1/2"

2"

Part Number	Description	Box Quantity	List Price Each Steel	Part Number	Description	Box Quantity	List Price Each Steel
NG08001	1-1/2" X CLOSE	25	\$1.51	NG09001	2" X CLOSE	25	\$1.93
NG08025	1-1/2" X 2-1/2"	25	\$1.85	NG09025	2" X 2-1/2"	25	\$2.31
NG08050	1-1/2" X 5"	25	\$2.98	NG09030	2" X 3"	25	\$2.55
				NG09045	2" X 4-1/2"	--	\$3.38

3"

4"

Part Number	Description	Box Quantity	List Price Each Steel	Part Number	Description	Box Quantity	List Price Each Steel
NG11001	3" X Close	10	\$4.81	NG12001	4" X CLOSE	10	\$6.51
NG11040	3" X 4"	10	\$5.19	NG12040	4" X 4"	10	\$8.58
NG11060	3" X 6"	10	\$7.23	NG12060	4" X 6"	10	\$9.34



Crimping Systems

C

Plated Steel Ferrules



Part Number	Hose Size	WALL THICKNESS	FERRULE LENGTH	FERRULE I.D.	List Price
F100-1PS	1"	0.049"	2-5/16"	1-36/64	\$1.23
F100-2PS	1"	0.049"	2-5/16"	1-40/64	\$1.34
F100-3PS	1"	0.049"	2-5/16"	1-44/64	\$1.40
F100-4PS	1"	0.049"	2-5/16"	1-48/64	\$1.40
F125-1PS	1-1/4"	0.065"	2-5/16"	1-52/64	\$1.83
F125-2PS	1-1/4"	0.065"	2-5/16"	1-56/64	\$1.92
F125-3PS	1-1/4"	0.065"	2-5/16"	1-60/64	\$1.98
F150-1PS	1-1/2"	0.065"	2-3/8"	2-4/64	\$1.98
F150-2PS	1-1/2"	0.065"	2-3/8"	2-8/64	\$2.08
F150-3PS	1-1/2"	0.065"	2-3/8"	2-12/64	\$2.36
F150-4PS	1-1/2"	0.065"	2-3/8"	2-16/64	\$2.43
F150-5PS	1-1/2"	0.065"	2-3/8"	2-20/64	\$2.43
F150-6PS	1-1/2"	0.065"	2-3/8"	2-24/64	\$2.45
F200-1PS	2"	0.065"	2-3/4"	2-32/64	\$2.55
F200-2PS	2"	0.065"	2-3/4"	2-36/64	\$2.66
F200-3PS	2"	0.065"	2-3/4"	2-40/64	\$2.74
F200-4PS	2"	0.065"	2-3/4"	2-44/64	\$2.83
F200-5PS	2"	0.065"	2-3/4"	2-48/64	\$3.02
F200-6PS	2"	0.065"	2-3/4"	2-52/64	\$3.11
F200-7PS	2"	0.065"	2-3/4"	2-56/64	\$3.17
F250-1PS	2-1/2"	0.085"	2-3/8"	3-12/64	\$4.53
F250-2PS	2-1/2"	0.085"	2-3/8"	3-16/64	\$4.53
F250-3PS	2-1/2"	0.085"	2-3/8"	3-20/64	\$4.62
F300-1PS	3"	0.085"	3-15/16"	3-36/64	\$5.28
F300-2PS	3"	0.085"	3-15/16"	3-40/64	\$5.38
F300-3PS	3"	0.085"	3-15/16"	3-44/64	\$5.38
F300-4PS	3"	0.085"	3-15/16"	3-48/64	\$5.62
F300-5PS	3"	0.085"	3-15/16"	3-52/64	\$5.75
F300-6PS	3"	0.085"	3-15/16"	3-56/64	\$5.85
F300-7PS	3"	0.085"	3-15/16"	3-60/64	\$6.42
F400-1PS	4"	0.120"	4-3/16"	4-40/64	\$9.34
F400-2PS	4"	0.120"	4-3/16"	4-44/64	\$9.53
F400-3PS	4"	0.120"	4-3/16"	4-48/64	\$9.72
F400-4PS	4"	0.120"	4-3/16"	4-52/64	\$9.87
F400-5PS	4"	0.120"	4-3/16"	4-56/64	\$10.00
F400-6PS	4"	0.120"	4-3/16"	5	\$10.19



Crimping Systems

Stainless Steel 304 Ferrules



	Part Number	Hose Size	WALL THICKNESS	FERRULE LENGTH	FERRULE I.D.	List Price
	F050-1SS	1/2"	0.049"	1-11/16"	1-4/64	\$1.72
	F050-2SS	1/2"	0.049"	1-11/16"	1-8/64	\$1.77
	F075-1SS	3/4"	0.049"	2-1/8"	1-20/64	\$2.30
	F075-2SS	3/4"	0.049"	2-1/8"	1-24/64	\$2.43
	F075-3SS	3/4"	0.049"	2-1/8"	1-28/64	\$2.53
	F100-1SS	1"	0.049"	2-5/16"	1-36/64	\$2.74
	F100-2SS	1"	0.049"	2-5/16"	1-40/64	\$2.92
	F100-3SS	1"	0.049"	2-5/16"	1-44/64	\$3.02
	F100-4SS	1"	0.049"	2-5/16"	1-48/64	\$3.17
	F125-1SS	1-1/4"	0.065"	2-5/16"	1-52/64	\$4.55
	F125-2SS	1-1/4"	0.065"	2-5/16"	1-56/64	\$4.87
	F125-3SS	1-1/4"	0.065"	2-5/16"	1-60/64	\$5.19
	F150-1SS	1-1/2"	0.065"	2-3/8"	2-4/64	\$5.26
	F150-2SS	1-1/2"	0.065"	2-3/8"	2-8/64	\$5.42
	F150-3SS	1-1/2"	0.065"	2-3/8"	2-12/64	\$5.75
	F150-4SS	1-1/2"	0.065"	2-3/8"	2-16/64	\$5.94
	F150-5SS	1-1/2"	0.065"	2-3/8"	2-20/64	\$6.19
	F150-6SS	1-1/2"	0.065"	2-3/8"	2-24/64	\$6.32
	F200-1SS	2"	0.065"	2-3/4"	2-32/64	\$6.70
	F200-2SS	2"	0.065"	2-3/4"	2-36/64	\$6.89
	F200-3SS	2"	0.065"	2-3/4"	2-40/64	\$7.08
	F200-4SS	2"	0.065"	2-3/4"	2-44/64	\$7.26
	F200-5SS	2"	0.065"	2-3/4"	2-48/64	\$7.74
	F200-6SS	2"	0.065"	2-3/4"	2-52/64	\$7.92
	F200-7SS	2"	0.065"	2-3/4"	2-56/64	\$8.21
	F250-1SS	2-1/2"	0.085"	2-3/8"	3-12/64	\$12.74
	F250-2SS	2-1/2"	0.085"	2-3/8"	3-16/64	\$13.11
	F250-3SS	2-1/2"	0.085"	2-3/8"	3-20/64	\$13.43
	F300-1SS	3"	0.085"	3-15/16"	3-36/64	\$15.85
	F300-2SS	3"	0.085"	3-15/16"	3-40/64	\$16.15
	F300-3SS	3"	0.085"	3-15/16"	3-44/64	\$16.60
	F300-4SS	3"	0.085"	3-15/16"	3-48/64	\$17.08
F300-5SS	3"	0.085"	3-15/16"	3-52/64	\$17.45	
F300-6SS	3"	0.085"	3-15/16"	3-56/64	\$17.55	
F300-7SS	3"	0.085"	3-15/16"	3-60/64	\$18.28	
F400-1SS	4"	0.120"	4-3/16"	4-40/64	\$29.21	
F400-2SS	4"	0.120"	4-3/16"	4-44/64	\$29.36	
F400-3SS	4"	0.120"	4-3/16"	4-48/64	\$30.09	
F400-4SS	4"	0.120"	4-3/16"	4-52/64	\$30.94	
F400-5SS	4"	0.120"	4-3/16"	4-56/64	\$31.64	
F400-6SS	4"	0.120"	4-3/16"	5	\$32.06	



Crimping Systems

C

Heavy Duty Industrial Hose Ferrules



Part Number	Hose ID	Hose OD Size Range	Working Press. psi	FERRULE SIZE			FWT	List Price
				OD	ID	LG		
HD200FA	2"	2-1/2" to 2-5/8"	800	3"	2-3/4"	3-1/2"	1/8"	\$5.47
HD200FB	2"	2-5/8" to 2-7/8"	800	3-1/4"	3"	3-1/2"	1/8"	\$6.43
HD200FC	2"	2-7/8" to 3-1/8"	800	3-1/2"	3-1/4"	3-1/2"	1/8"	\$6.79
HD250FA	2-1/2"	3" to 3-1/8"	800	3-1/2"	3-1/4"	4-1/4"	1/8"	\$7.26
HD250FB	2-1/2"	3-1/8" to 3-5/8"	800	4"	3-3/4"	4-1/4"	1/8"	\$8.87
HD300FA	3"	3-1/2" to 3-5/8"	800	4"	3-3/4"	5"	1/8"	\$9.34
HD300FB	3"	3-5/8" to 3-7/8"	800	4-1/2"	4"	5"	1/4"	\$16.94
HD300FC	3"	3-7/8" to 4"	800	4-1/2"	4-1/8"	5"	3/16"	\$14.81
HD300FD	3"	4" to 4-1/8"	800	4-1/2"	4-1/4"	5"	1/8"	\$11.23
HD300FE	3"	4-1/8" to 4-1/4"	800	5"	4-1/2"	5"	1/4"	\$20.55
HD400FA	4"	4-1/2" to 4-3/4"	500	5-1/4"	4-7/8"	5-1/2"	3/16"	\$16.70
HD400FB	4"	4-3/4" to 4-15/16"	500	5-9/16"	5-1/16"	5-1/2"	1/4"	\$23.89
HD400FC	4"	4-15/16" to 5-1/16"	500	5-9/16"	5-3/16"	5-1/2"	3/16"	\$19.40
HD400FD	4"	5-1/16" to 5-3/16"	500	5-9/16"	5-5/16"	5-1/2"	1/8"	\$15.47
HD400FE	4"	5-1/4" to 5-3/8"	500	6"	5-1/2"	5-1/2"	1/4"	\$27.51
HD400FF	4"	5-1/4" to 5-1/2"	500	6"	5-5/8"	5-1/2"	3/16"	\$21.49
HD500FA	5"	5-3/4" to 6"	500	6-5/8"	6-1/8"	6-7/8"	1/4"	\$34.66
HD500FB	5"	6" to 6-3/8"	500	7"	6-1/2"	6-5/8"	1/4"	\$38.77
HD600FA	6"	6-3/4" to 7-1/8"	500	7-5/8"	7-1/4"	7-1/2"	3/16"	\$34.66
HD600FB	6"	7-1/8" to 7-3/8"	500	8"	7-1/2"	7-1/2"	1/4"	\$45.89
HD600FC	6"	7-3/8" to 7-9/16"	500	8-3/16"	7-11/16"	7-1/2"	1/4"	\$49.85
HD600FD	6"	7-5/8" to 8"	500	8-5/8"	8-1/8"	7-1/2"	1/4"	\$49.68
HD800FA	8"	9" to 9-3/8"	300	10"	9-1/2"	8-3/4"	1/4"	\$64.92
HD800FB	8"	9-7/16" to 10-1/8"	300	10-3/4"	10-1/4"	8-1/2"	1/4"	\$69.79

Light Duty Industrial Hose Ferrules



Part Number	Hose ID	Hose OD Size Range	Working Press. psi	FERRULE SIZE			List Price
				OD	ID	LG	
LD150-1	1-1/2"	1-15/16" X 2"	350	2.40"	2.14"	2.8"	\$3.21
LD150-2	1-1/2"	2-1/64" X 2-1/8"	350	2.50"	2.26"	2.8"	\$3.21
LD150-3	1-1/2"	2-9/64" X 2-1/4"	350	2.60"	2.38"	2.8"	\$3.21
LD200-1	2"	2-9/16" to 2-5/8"	350	3.04"	2.75"	3.4"	\$5.28
LD200-2	2"	2-41/64" X 2-3/4"	350	3.14"	2.88"	3.4"	\$5.28
LD200-3	2"	2-49/64" X 2-7/8"	350	3.26"	3.01"	3.4"	\$5.28
LD250-1	2-1/2"	3-1/16" X 3-1/8"	250	3.55"	3.25"	3.7"	\$7.08
LD250-2	2-1/2"	3-9/64" X 3-1/4"	250	3.64"	3.35"	3.9"	\$7.08
LD300-1	3"	3-9/16" X 3-5/8"	250	4.00"	3.72"	4.6"	\$8.58
LD300-2	3"	3-41/64" X 3-3/4"	250	4.16"	3.87"	4.6"	\$9.15
LD300-3	3"	3-49/64" X 3-7/8"	250	4.26"	3.92"	4.6"	\$10.38
LD400-1	4"	4-5/8" X 4-11/16"	250	5.25"	4.95"	5.2"	\$13.58
LD400-2	4"	4-45/64" X 4-13/16"	250	5.38"	5.07"	5.4"	\$14.81
LD400-3	4"	4-53/64" X 4-15/16"	250	5.50"	5.13"	5.4"	\$17.51



CRIMP COUPLINGS

Crimping Systems

Crimp Sleeve, Plated Steel, Stainless Steel and Aluminum

Please make sure Crimp Sleeve is fitted for each side of hose to prevent cracking.

Length & Thickness

Size	Length	Wall Thickness	Size	Length	Wall Thickness
3/4"	1.575"	0.0472"	2	3.110"	0.0630"
1"	2.126"	0.0472"	2-1/2"	3.228"	0.0827"
1-1/4"	2.126"	0.0472"	3"	3.503"	0.0827"
1-1/2"	2.244"	0.0630"	4"	4.488"	0.1181"



Plated Steel Crimp Sleeves				Stainless Steel Crimp Sleeves			Aluminum Crimp Sleeves		
Size	Part Number Plated Steel	Fits Hose O.D. From-To	List Price	Part Number Stainless Steel	Fits Hose O.D. From-To	List Price	Part Number Aluminum	Fits Hose O.D. From-To	List Price
3/4"	075-1PS	1-3/64" to 1-8/64"	\$0.62	075-1SS	1-3/64" to 1-8/64"	\$1.42	075-1A	1-3/64" to 1-8/64"	\$1.58
3/4"	075-2PS	1-7/64" to 1-12/64"	\$0.66	075-2SS	1-7/64" to 1-12/64"	\$1.51	075-2A	1-7/64" to 1-12/64"	\$1.62
3/4"	075-3PS	1-11/64" to 1-16/64"	\$0.66	075-3SS	1-11/64" to 1-16/64"	\$1.57	075-3A	1-11/64" to 1-16/64"	\$1.75
1"	100-1PS	1-27/64" to 1-32/64"	\$0.81	100-1SS	1-27/64" to 1-32/64"	\$2.26	100-1A	1-27/64" to 1-32/64"	\$1.81
1"	100-2PS	1-31/64" to 1-36/64"	\$0.85	100-2SS	1-31/64" to 1-36/64"	\$2.26	100-2A	1-31/64" to 1-36/64"	\$1.89
1"	100-3PS	1-35/64" to 1-40/64"	\$0.85	100-3SS	1-35/64" to 1-40/64"	\$2.32	100-3A	1-35/64" to 1-40/64"	\$2.38
1-1/4"	125-1PS	1-47/64" to 1-52/64"	\$1.00	125-1SS	1-47/64" to 1-52/64"	\$2.64	125-1A	1-47/64" to 1-52/64"	\$2.47
1-1/4"	125-2PS	1-51/64" to 1-56/64"	\$1.00	125-2SS	1-51/64" to 1-56/64"	\$2.74	125-2A	1-51/64" to 1-56/64"	\$2.55
1-1/4"	125-3PS	1-55/64" to 1-61/64"	\$1.23	125-3SS	1-55/64" to 1-61/64"	\$3.43	125-3A	1-55/64" to 1-61/64"	\$2.72
1-1/2"	150-1PS	1-51/64" to 1-56/64"	\$1.34	150-1SS	1-51/64" to 1-56/64"	\$3.77	150-1A	1-51/64" to 1-56/64"	\$2.83
1-1/2"	150-2PS	1-59/64" to 2"	\$1.34	150-2SS	1-59/64" to 2"	\$3.77	150-2A	1-59/64" to 2"	\$2.83
1-1/2"	150-3PS	1-63/64" to 2-4/64"	\$1.38	150-3SS	1-63/64" to 2-4/64"	\$3.98	150-3A	1-63/64" to 2-4/64"	\$3.15
1-1/2"	150-4PS	2-3/64" to 2-8/64"	\$1.43	150-4SS	2-3/64" to 2-8/64"	\$4.21	150-4A	2-3/64" to 2-8/64"	\$3.36
1-1/2"	150-5PS	2-11/64" to 2-16/64"	\$1.43	150-5SS	2-11/64" to 2-16/64"	\$4.19	150-5A	2-11/64" to 2-16/64"	\$3.53
2"	200-1PS	2-19/64" to 2-24/64"	\$2.02	200-1SS	2-19/64" to 2-24/64"	\$5.94	200-1A	2-19/64" to 2-24/64"	\$4.49
2"	200-2PS	2-31/64" to 2-36/64"	\$2.15	200-2SS	2-31/64" to 2-36/64"	\$6.51	200-2A	2-31/64" to 2-36/64"	\$4.62
2"	200-3PS	2-35/64" to 2-40/64"	\$2.21	200-3SS	2-35/64" to 2-40/64"	\$6.60	200-3A	2-35/64" to 2-40/64"	\$4.70
2"	200-4PS	2-39/64" to 2-44/64"	\$2.34	200-4SS	2-39/64" to 2-44/64"	\$7.13	200-4A	2-39/64" to 2-44/64"	\$4.77
2"	200-5PS	2-43/64" to 2-48/64"	\$2.34	200-5SS	2-43/64" to 2-48/64"	\$7.17	200-5A	2-43/64" to 2-48/64"	\$5.02
2"	200-6PS	2-47/64" to 2-52/64"	\$2.34	200-6SS	2-47/64" to 2-52/64"	\$7.64	200-6A	2-47/64" to 2-52/64"	\$5.19
2"	200-7PS	2-55/64" to 2-60/64"	\$2.49	200-7SS	2-55/64" to 2-60/64"	\$7.64	200-7A	2-55/64" to 2-60/64"	\$5.30
2"	200-8PS	2-59/64" to 3"	\$2.49	200-8SS	2-59/64" to 3"	\$7.64	200-8A	2-59/64" to 3"	\$5.51
2-1/2"	250-1PS	2-63/64" to 3-4/64"	\$3.45	250-1SS	2-63/64" to 3-4/64"	\$10.57	250-1A	2-63/64" to 3-4/64"	\$6.49
2-1/2"	250-2PS	3-7/64" to 3-12/64"	\$3.45	250-2SS	3-7/64" to 3-12/64"	\$10.57	250-2A	3-7/64" to 3-12/64"	\$6.89
2-1/2"	250-3PS	3-11/64" to 3-16/64"	\$3.45	250-3SS	3-11/64" to 3-16/64"	\$10.57	250-3A	3-11/64" to 3-16/64"	\$6.96
3"	300-1PS	3-23/64" to 3-28/64"	\$3.77	300-1SS	3-23/64" to 3-28/64"	\$11.98	300-1A	3-23/64" to 3-28/64"	\$7.94
3"	300-2PS	3-31/64" to 3-36/64"	\$3.96	300-2SS	3-31/64" to 3-36/64"	\$11.98	300-2A	3-31/64" to 3-36/64"	\$8.02
3"	300-3PS	3-35/64" to 3-40/64"	\$3.96	300-3SS	3-35/64" to 3-40/64"	\$11.98	300-3A	3-35/64" to 3-40/64"	\$8.02
3"	300-4PS	3-39/64" to 3-44/64"	\$4.38	300-4SS	3-39/64" to 3-44/64"	\$12.83	300-4A	3-39/64" to 3-44/64"	\$8.11
3"	300-5PS	3-43/64" to 3-48/64"	\$4.28	300-5SS	3-43/64" to 3-48/64"	\$11.98	300-5A	3-43/64" to 3-48/64"	\$8.30
3"	300-6PS	3-47/64" to 3-52/64"	\$4.40	300-6SS	3-47/64" to 3-52/64"	\$11.98	300-6A	3-47/64" to 3-52/64"	\$8.40
3"	300-7PS	3-51/64" to 3-56/64"	\$4.43	300-7SS	3-51/64" to 3-56/64"	\$11.98	300-7A	3-51/64" to 3-56/64"	\$8.51
3"	300-8PS	3-55/64" to 3-60/64"	\$4.43	300-8SS	3-55/64" to 3-60/64"	\$11.98	300-8A	3-55/64" to 3-60/64"	\$8.68
3"	300-9PS	3-63/64" to 4-4/64"	\$4.62	300-9SS	3-63/64" to 4-4/64"	\$12.74	300-9A	3-63/64" to 4-4/64"	\$8.83
4"	400-1PS	4-23/64" to 4-28/64"	\$6.66	400-1SS	4-23/64" to 4-28/64"	\$19.64	400-1A	4-23/64" to 4-28/64"	\$13.02
4"	400-2PS	4-31/64" to 4-36/64"	\$6.66	400-2SS	4-31/64" to 4-36/64"	\$19.64	400-2A	4-31/64" to 4-36/64"	\$13.17
4"	400-3PS	4-39/64" to 4-44/64"	\$8.96	400-3SS	4-39/64" to 4-44/64"	\$24.34	400-3A	4-39/64" to 4-44/64"	\$13.34
4"	400-4PS	4-43/64" to 4-48/64"	\$8.96	400-4SS	4-43/64" to 4-48/64"	\$24.34	400-4A	4-43/64" to 4-48/64"	\$13.64
4"	400-5PS	4-47/64" to 4-52/64"	\$8.96	400-5SS	4-47/64" to 4-52/64"	\$24.51	400-5A	4-47/64" to 4-52/64"	\$13.87
4"	400-6PS	4-55/64" to 4-60/64"	\$9.23	400-6SS	4-55/64" to 4-60/64"	\$25.47	400-6A	4-55/64" to 4-60/64"	\$14.19
4"	400-7PS	4-63/64" to 5-4/64"	\$9.34	400-7SS	4-63/64" to 5-4/64"	\$29.45	400-7A	4-63/64" to 5-4/64"	\$14.43

Working pressures are determined by the type of couplings and hose used. See NAHAD Hose Assembly Guidelines.



FOOT VALVES AND STRAINERS

Foot Valves and Replacement Parts

C

										
Foot Valves			Strainer		Neoprene Flapper Gasket & Weight		Neoprene Flapper Gaskets		Steel Plate	
Size	Part Number	List Price	Part Number	List Price	Part Number	List Price	Part Number	List Price	Part Number	List Price
1-1/2"	FV 20B	\$11.87	FVS 20B	\$7.45	FVF 20B	\$3.30	FVG 20B	\$1.21	FVP 20B	\$2.17
2"	FV 25B	\$16.89	FVS 25B	\$6.89	FVF 25B	\$4.91	FVG 25B	\$1.81	FVP 25B	\$2.92
2-1/2"	FV 30B	\$21.89	--	--	--	--	--	--	--	--
3"	FV 35B	\$28.68	FVS 35B	\$7.92	FVF 35B	\$4.96	FVG 35B	\$5.94	FVP 35B	\$3.87
4"	FV 40B	\$50.47	FVS 40B	\$17.47	FVF 40B	\$5.66	FVG 40B	\$6.89	FVP 40B	\$9.91
6"	FV 60B	\$118.77	FVS 60B	\$24.06	FVF 60B	\$12.74	FVG 60B	\$10.19	FVP 60B	\$32.98
8"	FV 80B	\$269.92	FVS 80B	\$28.28	FVF 80B	\$24.68	FVG 80B	\$18.21	FVP 80B	\$56.58

Strainers Cold-Rolled Steel-Plated



RH

Round Hole



RS

Round Hole Long



SKBH

Skimmer
Round Hole Bottom



SH

Square Hole



RD

Round Hole
Hose End



SKTH

Skimmer
Round Hole Top

Size	Part Number	List Price	Part Number	List Price	Part Number	List Price	Part Number	List Price	Part Number	List Price	Part Number	List Price
1 - 1/2"	RH 20B	\$6.32	SH 20B	\$6.13	RS 20B	\$4.72	RD 20T	\$4.91	SK 20BH	\$14.72	SK 20TH	\$14.34
2"	RH 25B	\$7.92	SH 25B	\$7.26	RS 25B	\$5.38	RD 25T	\$6.23	SK 25BH	\$14.72	SK 25TH	\$14.34
2 - 1/2"	RH 30B	\$8.87	SH 30B	\$8.13	RS 30B	\$6.23	--	--	--	--	--	--
3"	RH 35B	\$10.98	SH 35B	\$10.09	RS 35B	\$8.58	RD 35T	\$8.96	SK 35BH	\$18.77	SK 35TH	\$18.83
4"	RH 40B	\$12.08	SH 40B	\$11.08	RS 40B	\$10.74	RD 40T	\$8.96	--	--	--	--
6"	RH 60B	\$23.58	SH 60B	\$20.28	RS 60B	\$19.72	--	--	--	--	--	--
8"	RH 80B	\$43.13	SH 80B	\$43.13	RS 80B	\$31.04	--	--	--	--	--	--



FOOT VALVES AND STRAINERS

Poly Strainer



Size	Part Number	List Price
1-1/2"	RH 20PP	\$4.45
2"	RH 25PP	\$4.45
3"	RH 35PP	\$11.98

SS Strainer 304 Stainless Steel Round Hole Strainers



RH

Round Hole

Size	Part Number	List Price
1-1/2"	RHSS 20B	\$20.28
2"	RHSS 25B	\$28.68
3"	RHSS 35B	\$40.30
4"	RHSS 40B	\$45.58
6"	RHSS 60B	\$94.08

Funnel Strainer



304 Stainless Steel With Built-In Buna Gasket

- To be used with female cam and groove Part 'D'
- Pre-attached Buna gasket

Size	Part Number	List Price
3"	FS 35	\$19.23
4"	FS 40	\$27.70

Threaded Sight Glass



Sight Glass is made from polycarbonate material and has a temperature range from -50 to +185 °F.

DO NOT USE A WRENCH ON SIGHT GLASS

Size	Part Number	List Price
3"	TSG 300	\$48.96
4"	TSG 400	\$107.55

Pump Filter



Screws Into Female NPT Thread Coupler



Aluminum

304 Stainless Steel

Size	1/4" Hole Part Number	List Price	1/2" Hole Part Number	List Price	1/4" Hole Part Number	List Price	1/2" Hole Part Number	List Price
2"	PF200AL025	\$8.66	PF200AL050	\$7.26	PF200SS025	\$16.58	PF200SS050	\$15.38
3"	PF300AL025	\$10.85	PF300AL050	\$12.08	PF300SS025	\$21.64	PF300SS050	\$20.74
4"	PF400AL025	\$16.89	PF400AL050	\$20.00	PF400SS025	\$26.94	PF400SS050	\$26.40



BAUER TYPE COUPLINGS

Not Recommended for Chemicals or Hazardous Type Materials.

C





		Size	Part Number	List Price
	<p>Complete Sets</p> <ul style="list-style-type: none"> —Female Hose End —Male Hose End —Locking Lever —O-ring <p>Zinc Plated Steel</p> <p>*10" and 12" is type A w/lever permanently attached to female end</p>	2"	BTC200	\$29.72
		3"	BTC300	\$48.96
		4"	BTC400	\$82.92
		6"	BTC600	\$129.98
		8"	BTC800	\$218.77
		10"	BTC1000	\$726.42
		12"	BTC1200	\$1283.02
			<p>Male With Hose Shank</p> <p>Male Coupling With Hose Barb</p> <p>Zinc Plated Steel</p>	2"
3"	BTC300M			\$15.53
4"	BTC400M			\$28.26
6"	BTC600M			\$42.26
8"	BTC800M			\$82.74
10"	BTC1000M			\$386.79
12"	BTC1200M			\$603.77
	<p>Female With Hose Shank</p> <p>Female Coupling With Hose Barb</p> <p>Zinc Plated Steel</p> <p>*10" and 12" is type A w/lever permanently attached to female end</p>	2"	BTC200F	\$9.79
		3"	BTC300F	\$14.36
		4"	BTC400F	\$25.85
		6"	BTC600F	\$44.34
		8"	BTC800F	\$76.70
		10"	BTC1000F	\$386.79
		12"	BTC1200F	\$764.15
	<p>Lever Ring</p> <p>Ring with locking clamps used to connect the male and female couplings together.</p> <p>Plain Steel</p>	2"	BTC200LR	\$12.55
		3"	BTC300LR	\$19.81
		4"	BTC400LR	\$29.25
		6"	BTC600LR	\$53.94
		8"	BTC800LR	\$70.19
		--	--	--
		--	--	--
	<p>Rubber O-Ring</p> <p>Buna-N rubber O-Ring used between female and male coupling.</p>	2"	BTC200G	\$0.72
		3"	BTC300G	\$1.36
		4"	BTC400G	\$2.68
		6"	BTC600G	\$5.75
		8"	BTC800G	\$7.53
		10"	BTC1000G	\$16.42
		12"	BTC1200G	\$28.00



BAUER TYPE COUPLINGS

Not Recommended for Chemicals or Hazardous Type Materials.



	<p>Complete Flanged Sets</p> <ul style="list-style-type: none"> —Female with Flange —Male with Flange —Locking Lever —O-ring <p>Zinc Plated Steel</p>	Size	Part Number	List Price
		2"	BTC200FL	\$97.55
		3"	BTC300FL	\$131.43
		4"	BTC400FL	\$210.47
		6"	BTC600FL	\$363.91
		8"	BTC800FL	\$530.64
	<p>Male with Flange</p> <p>Male Coupling with Flange</p> <p>Zinc Plated Steel</p>	Size	Part Number	List Price
		2"	BTC200FLM	\$55.98
		3"	BTC300FLM	\$76.94
		4"	BTC400FLM	\$123.64
		6"	BTC600FLM	\$206.87
		8"	BTC800FLM	\$291.09
	<p>Female with Flange</p> <p>Female Coupling with Flange</p> <p>Zinc Plated Steel</p>	Size	Part Number	List Price
		2"	BTC200FLF	\$40.17
		3"	BTC300FLF	\$51.13
		4"	BTC400FLF	\$81.51
		6"	BTC600FLF	\$144.34
		8"	BTC800FLF	\$225.13
	<p>Safety Clips</p>	Size	Part Number	List Price
		2" & 3"	SP2030	\$0.60
		4"	SP400	\$0.58
		6" & 8"	SP6080	\$2.08

Safety Note: Using safety clips is highly recommended.

Warning: Working pressure may vary depending on how the couplings are attached to the hose assembly. Before operation, always check the hose assembly for proper attachment and that couplings are in working order.



BAUER TYPE COUPLINGS

Not Recommended for Chemicals or Hazardous Type Materials.

C



Complete Sets with Male Threads

- Female with male thread
- Male with male thread
- Locking lever
- O-ring

Zinc Plated Steel

Size	Part Number	List Price
2"	BTC200MT	\$36.74
3"	BTC300MT	\$54.28
4"	BTC400MT	\$103.42
6"	BTC600MT	\$181.32
8"	BTC800MT	\$265.30



Male with Male Threads

Zinc Plated Steel

Size	Part Number	List Price
2"	BTC200MTM	\$9.26
3"	BTC300MTM	\$15.33
4"	BTC400MTM	\$29.94
6"	BTC600MTM	\$59.96
8"	BTC800MTM	\$77.91



Female with Male Threads

Zinc Plated Steel

Size	Part Number	List Price
2"	BTC200MTF	\$12.40
3"	BTC300MTF	\$17.09
4"	BTC400MTF	\$36.15
6"	BTC600MTF	\$69.68
8"	BTC800MTF	\$117.85

Safety Note: Using safety clips is highly recommended.

Warning: Working pressure may vary depending on how the couplings are attached to the hose assembly. Before operation, always check the hose assembly for proper attachment and that couplings are in working order.



SHANK COUPLINGS

Brass Shank Couplings

Poly Shank Couplings

			 1/2" to 1-1/4" 1-1/2" to 3"				
Complete Set			Long Shank		Short Shank		
Size	Part Number	List Price	Part Number	List Price	Size	Part Number	List Price
Complete Set							
1/2" x 3/4" IPT	BLS050075	\$9.81	BSS050075	\$7.51	1"	PP100S	\$2.72
1/2" x 3/4" GHT	BLS050075GHT	\$9.34	BSS050075GHT	\$7.51	1-1/4"	PP125S	\$4.28
5/8" x 3/4" IPT	BLS058075	\$10.66	BSS058075	\$7.74	1-1/2"	PP150S	\$5.58
5/8" x 3/4" GHT	BLS058075GHT	\$11.23	BSS058075GHT	\$7.74	2"	PP200S	\$7.34
3/4" x 3/4" IPT	BLS075	\$13.17	BSS075	\$8.26	3"	PP300S	\$15.53
3/4" x 3/4" GHT	BLS075GHT	\$11.68	BSS075GHT	\$8.26	Female		
1" x 1" IPT	BLS100	\$14.89	BSS100	\$12.60	1"	PP100F	\$1.62
1-1/4" x 1-1/4" IPT	BLS125	\$25.45	BSS125	\$14.74	1-1/4"	PP125F	\$2.83
1-1/2" x 1-1/2" IPT	BLS150	\$35.19	BSS150	\$17.66	1-1/2"	PP150F	\$3.77
1-1/2" x 1-1/2" NST	BLS150NH	\$44.66	BSS150NH	\$17.66	2"	PP200F	\$4.74
2" x 2" IPT	BLS200	\$46.79	BSS200	\$25.47	3"	PP300F	\$9.89
2-1/2" x 2-1/2" IPT	--	--	BSS250	\$52.17	Male		
2-1/2" x 2-1/2" NST	--	--	BSS250NH	\$59.89	1"	PP100M	\$1.02
3" x 3" IPT	--	--	BSS300	\$61.89	1-1/4"	PP125M	\$1.42
Price of Male: 1/2 of Complete Set Price of Female: 2/3 of Complete Set				1-1/2"	PP150M	\$1.75	
				2"	PP200M	\$2.62	
				3"	PP300M	\$5.51	



Aluminum Shank with Brass Nut (NPSH Threads)

Washers

							Replacement Washers for Shank Couplings (S.B.R.)		
Complete Set			Female Shank w/ Pin Lug Swivel Nut		Male Shank		Coupling Size	Part Number	List Price
Size	Part Number	List Price	Part Number	List Price	Part Number	List Price	3/4"	RW075	\$0.21
1-1/2"	AL150S	\$7.74	AL150F	\$5.85	AL150M	\$1.98	1"	RW100	\$0.21
2"	AL200S	\$10.58	AL200F	\$7.64	AL200M	\$3.28	1-1/4"	RW125	\$0.21
2-1/2"	AL250S	\$13.96	AL250F	\$16.51	AL250M	\$5.19	1-1/2"	RW150	\$0.19
3"	AL300S	\$19.96	AL300F	\$14.49	AL300M	\$6.75	2"	RW200	\$0.26
4"	AL400S	\$35.09	AL400F	\$24.62	AL400M	\$12.17	2-1/2"	RW250	\$0.34
6"	AL600S	\$73.30	AL600F	\$52.74	AL600M	\$23.49	3"	RW300	\$0.45
1-1/2"	AL150S-NST	\$10.47	AL150F-NST	\$9.43	AL150M-NST	\$4.19	4"	RW400	\$0.62
2-1/2"	AL250S-NST	\$21.68	AL250F-NST	\$18.55	AL250M-NST	\$10.09	5"	--	--
							6"	RW600	\$1.19

Note: Working pressures are directly related to the hose and coupling installation.



Seal Fast Clamps



Double Bolt Clamps

USA Sized

(Zinc Plated)

C

Double Bolt Clamps (Zinc Plated)

Please check Hose O.D. before ordering.

Part Number	Hose O.D New	List Price
DB0400SF	3-16/32" X 3-26/32"	\$6.04
DB0463SF	4-1/32" X 4-9/32"	\$7.98
DB0525SF	4-8/32" X 4-30/32"	\$9.15
DB0550SF	4-16/32" X 5-8/32"	\$9.43
DB0600SF	5-4/32" X 5-22/32"	\$9.79
DB0675SF	5-3/32" X 6-16/32"	\$11.89
DB0769SF	6-16/32" X 7-18/32"	\$16.06
DB0818SF	7-22/32" X 8-6/32"	\$21.83
DB0875SF	8-8/32" X 8-28/32"	\$20.57
DB0988SF	8-30/32" X 9-28/32"	\$31.98
DB1125SF	9-30/32" X 11-12/32"	\$39.62
DB1275SF	1-6/32" X 13"	\$63.11
DB1450SF	13-6/32" X 15"	\$75.77

Part Number *	Hose O.D New	List Price	Part Number	Hose O.D New	List Price
0022 DB	21/32" To 7/8"	\$1.19	0550 DBU	4-1/8" To 4-5/8"	\$9.34
0029 DB	7/8" To 1-9/64"	\$1.70	0600 DBU	4-7/8" To 5-1/4"	\$10.36
0034 DB	1-5/16" to 1-11/32"	\$1.74	0675 DBU	5-5/8" To 6-5/8"	\$11.11
0040 DB	1-15/32" To 1-25/32"	\$2.57	0769 DBU	6-1/2" To 6-3/4"	\$14.51
0049 DB	1-3/4" To 1-15/16"	\$3.09	0818 DBU	6-1/2" To 7-3/4"	\$21.98
0060 DB	1-7/8" To 2-3/8"	\$3.68	0875 DBU	7-5/8" To 8-1/4"	\$23.49
0076 DB	2-3/8" To 2-7/8"	\$4.25	0988 DBU	8-3/8" To 9-1/8"	\$25.94
0094 DB	3-1/2" To 3-11/16"	\$6.51	--	--	--
0400 DBU	2-3/4" To 3-1/2"	\$6.06	--	--	--
0463 DBU	3-1/2" To 4-1/8"	\$6.23	--	--	--
0525 DBU	4-1/4" To 4-5/8"	\$9.34	--	--	--

* U - Undersized

Spiral Hose Clamps (Zinc Plated)

Spiral Bolt Clamps

Size	Part Number Left Hand	Part Number Right Hand	List Price
2"	200 SCL	200 SCR	\$1.85
2-1/2"	250 SCL	250 SCR	\$2.38
3"	300 SCL	300 SCR	\$2.74
4"	400 SCL	400 SCR	\$5.09
5"	500 SCL	500 SCR	\$5.70
6"	600 SCL	600 SCR	\$6.89
8"	800 SCL	800 SCR	\$9.62
10"	1000 SCL	1000 SCR	\$13.00
12"	1200 SCL	1200 SCR	\$16.02



Left Hand
Spiral



Right Hand
Spiral

Recommended for PVC suction or discharge.

Clamps for Universal Hose Couplings and Ground Joints

Please check Hose O.D. before ordering.		Cast Iron Zinc Plated							
Hose I.D.	For Hose O.D.		Part Number	List Price	Hose I.D.	For Hose O.D.		Part Number	List Price
	From	To				From	To		
3/8"	11/16"	7/8"	SF1	\$2.34	1-1/4"	1-25/32"	2-3/32"	SF19U	\$13.68
1/2"	13/16"	15/16"	SF2	\$2.74	1-1/2"	2-3/16"	2-3/8"	SF24U	\$12.74
1/2"	15/16"	1-1/16"	SF4	\$2.62	1-1/2"	2-1/4"	2-9/16"	SF24	\$15.94
1/2"	1-1/16"	1-3/16"	SF5	\$2.74	1-1/2"	2-9/16"	2-3/4"	SF25	\$15.89
3/4"	1-1/8"	1-5/16"	SF9A	\$2.89	2"	2-1/2"	2-25/32"	SF29U	\$17.64
3/4"	1-3/16"	1-5/16"	SF9U	\$3.64	2"	2-3/4"	3-1/16"	SF29	\$17.92
3/4"	1-5/16"	1-1/2"	SF9B	\$4.26	2"	3-3/32"	3-7/16"	SF30	\$20.28
3/4"	1-1/2"	1-11/16"	SF10	\$5.58	4"	4-1/16"	4-7/16"	SF39	\$45.94
1"	1-17/32"	1-23/32"	SF14U	\$7.57	4"	4-7/8"	5-5/16"	SF49U	\$108.77
1"	1-11/16"	1-15/16"	SF14	\$8.68	4"	5-1/8"	6-3/16"	SF49	\$113.96



3/8" to 3/4" ID



1" to 2" ID

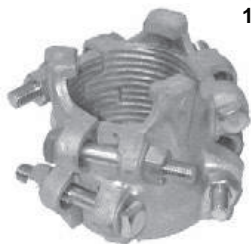

4" ID

S'MOOTH™ Thread Sealant with PTFE



Part Number	Description	List Price
15005	1/4 Pt. Plastic-Brush Top	\$15.19
15008	1/2 Pt. Plastic-Brush Top	\$23.58
15018	1 Pt. Plastic-Brush Top	\$39.02

S'MOOTH™ is a general-purpose metal pipe thread sealant for industrial and residential use. This white paste has a smooth consistency and no grit.

Applications: Pipe thread sealant for 1/2" to 2" NPT metal piping. For 1-1/2" to 2" NPT, we recommend putting a thin coating on both the female and male threads. For systems carrying potable water, steam, compressed air, natural gas, sprinkler systems, gasoline, diesel fuel, kerosene, heating oil, propane, anti-freeze solutions, refrigeration gases, dilute acids, caustics and many other common chemicals. Use for repair and maintenance in many industries including marine, automotive, plumbing, pool and spa, food service, agricultural, institutional, municipal and utilities.

Features and Benefits:

- Fast drying
- Non-toxic, non-corrosive
- Food Grade compliant, suitable for incidental food contact under FDA Regulation CFR 175.300
- Suitable for uses in potable water
- Long service life and good chemical resistance
- Excellent lubrication, eases assembly, resists

PTFE Joint Sealant



PTFE Joint Sealant is a 100% expanded PTFE gasket material. It comes in a soft, pliable ribbon with a self-adhesive tape applied to one side. It is a tough, flexible and economical universal gasket that replaces cut gaskets in a variety of regular and service applications. PTFE joint sealant will not deteriorate with age. It is unaffected by common chemicals, will withstand pressures up to 3,000 psi and temperatures -450° F to +600° F (-268° C to +316° C). This unique material is highly compressible and will fill severe irregularities in sealing surfaces.

Applications Include:

Flanges, pump and compressor housings, heat exchanger, manhole covers, on rough or irregular surfaces, FRP vessels, steam vessel flanges, concrete lids, glass joints, food service and processes. PTFE joint sealant is spooled in a range of sizes from 1 to 25 mm in diameter (3/64" to 1"). Cut material with scissors and apply to sealing surface. Self-adhesive strip will hold firmly in place. **Available in:** spools of 1/4", 3/8", 1/2", and 3/4" diameters.



Features and Benefits:

- Self-adhesive-easy to work
- Flanges part easily
- No re-torquing required
- Will not deteriorate with age
- Resists cold flow and creep
- Reduces inventory of cut gaskets
- Meets FDA requirements

Part Number	Description	List Price
28007	1/4" X 50' PTFE Joint Sealant	\$79.25
28010	3/8" X 25' PTFE Joint Sealant	\$64.15
28014	1/2" X 15' PTFE Joint Sealant	\$66.04
28020	3/4" X 15' PTFE Joint Sealant	\$141.51

PTFE Tape

D

<p>Packed 100 rolls per carton Assorted sizes.</p> 	<p>* Premium PTFE Tapes 1/2" Width</p> 	Part Number	Size X Length	List Price Per Roll
		26130	1/2" x 260"	\$1.00
		26135	1/2" x 520"	\$1.17
		26140	1/2" x 1296"	\$5.17
		26145	3/4" x 260"	\$1.23
		26150	3/4" x 520"	\$1.87
		26160	1" x 520"	\$2.26
		* 46231	1/2" x 260"	\$8.79
		* 46330	1/2" x 260"	\$5.19
		* 26031M	1/2" x 260"	\$5.49

46231 GRAY STAINLESS STEEL PTFE THREAD SEAL TAPE

This tape has nickel pigment color added for use on all stainless steel fittings. Prevents galling, seizing or corrosion. A high density rating, this is the tape for coarse stainless steel threads. Also carries a temperature range of -450F to +550F. Exceeds Mil. Spec. T-27730A. UL Listed

46330 YELLOW GAS LINE PTFE THREAD SEAL TAPE

Designed for gas lines of all types... Natural gas, propane and butane lines. Meets gas company standards world wide. Full density (1.6) makes this the heaviest tape available. Seals threads easily and quickly with confidence. Has a temperature range of -450F to +550F. Exceeds Mil. Spec. T-27730A, UL Listed

26031M GREEN OXYGEN PTFE THREAD SEAL TAPE

Color coded green for oxygen applications. Grease free, density of 1.2. This is the tape for all your oxygen lines. Will not support combustion. Temperature range of -450F to +550F. Exceeds Mil. Spec. T-27730A. UL Listed

TFE™ Pipe Thread Sealant w/PTFE

Part Number	Description	List Price
14005	1/4 Pt. Plastic-Brush Top	\$12.79
14012	1/2 Pt. Plastic-Brush Top	\$19.23
14018	1 Pt. Plastic-Plain Top	\$29.81
14025	1Qt. Plastic-Plain Top	\$50.00

TFE is a superior grade, non-hardening, easy to apply, heavy duty pipe thread sealant. It is formulated to a thick paste consistency, fortified with an extra amount of PTFE and PTFE materials to insure a positive seal with less effort. TFE is designed for all pipe fitters, fabricators, plumbers and mechanical contractors. Because of its unique solids content, TFE fills thread imperfections and provides leak-proof joints that seal for the life of the connection.

FEATURES and BENEFITS:

- Heavy-Duty Sealant
- Non-Staining
- Non-Hardening
- Non-Toxic
- Non-Dripping - can be applied to newly cut hot threads

- Prevents corrosion, seizing and galling
- Contains no solvents
- Non-Corrosive
- Self-Lubricating
- Non-Hazardous

TFE is recommended for pipe threads carrying water, steam, LP and natural gas, refrigerants, solvents, caustics, dilute acids, oils and diesel fuel. Withstands temperatures to 500°F (260°C) and pressures to 10,000 **psi** (Liquid), 2000 **psi** (gas).

Applications: All pipe and threaded connections-Cast Iron, Malleable, Brass, Copper, Stainless Steel, PVC, CPVC, ABS and Polypropylene.

WARNING

"DO NOT USE ON OXYGEN SYSTEMS"



Cop-Graf™ Copper and Graphite Based Anti-Seize Compound



Cop-Graf is a top quality anti-seize compound composed of pure copper particles and graphite in a high heat resistant carrier. It is designed to lubricate and protect threaded connections and flanges at temperatures to 1800° F (980° C) and extreme load pressure conditions. Cop-Graf has water resistant and anti-oxidant properties that prevent seizing and galling, while protecting against rust and corrosion. Cop-Graf does not separate. It is non-dripping, non-hardening, permits quick, easy disassembly and removal of connection even after lengthy service or severe conditions. Stress, strain and time to disassemble are greatly diminished. Exceeds MIL-A-907 specifications.

Part Number	Description	List Price
11010	Anti-Seize Compound Brush Top 8 oz.	\$22.55
11018	Anti-Seize Compound Brush Top 1 lb.	\$37.36

Anti-Seize Special™

Aluminum, Copper and Graphite Based Anti-Seize Compound

Anti-Seize Special is a superior grade assembly compound and high pressure lubricant. This high quality aluminum, copper and graphite based anti-seize formula has unique particle shapes suspended in special carriers. It will protect metal parts under extreme heat, pressure and contaminating conditions to 2000° F (1095° C). Anti-seize Special is designed with ultra fine metallic and graphite particles enhancing a longer lasting protective film, resisting washout, burn-off and corrosion. Exceeds MIL-A-907 specifications.

Cop-Graf and Anti-Seize Special

Features and Benefits:

- Protects against rust and corrosion
- Reduces friction--Provides constant torque/tension
- Speeds assembly of disassembly
- Prevents seizing, galling and cold welding
- Retards galvanic action between dissimilar metals
- Resists salt water corrosion
- Compatible with all types of metals/most



Part Number	Description	List Price
18014	Anti-Seize Special 12.5 oz. Aerosol	\$28.81

Nickel-Graf™ Nickel and Graphite Based Anti-Seize Compound

Nickel-Graf is a premium quality anti-seize lubricant designed especially for maximum resistance to the most corrosive and extreme temperature environments. Performs to temperatures of 2600° F (1426° C). Nickel-Graf is composed of pure colloidal nickel and graphite flakes dispensed in a superior high performance petroleum carrier. It does not contain any copper, lead or molybdisulfide. Nickel-Graf will not poison catalyst beds, reaction chambers or special alloy fittings. It is safe to use with anhydrous ammonia, acetylene and other vinyl monomers. Exceeds MIL-A-907 specifications.

Features and Benefits:

- Offers maximum protection from acids, caustics, chemicals, and extreme heat
- Eliminates galling and cold welding
- Protects against corrosion and oxidation
- Reduces friction and lowers torque
- Provides a nickel plating as a barrier between metal surfaces

Part Number	Description	List Price
13008	Anti-Seize Compound Brush Top 8 oz.	\$43.49
13018	Anti-Seize Compound Brush Top 1 lb.	\$80.94



Anaerobic Sealing Compounds Pipe Sealants with PTFE

D

Anaerobic Sealing Compounds will withstand temperatures from -65° F to +375° F. Seals to 1,000 psi immediately after application and up to burst rating of typical pipe after curing. Due to its small particle size, will not clog small orifices, valve openings and screens typically found in most hydraulic systems.

Applications Include: Most metal threads, particularly steel and brass. Ideal for fittings, pipes, valves, gauges and connections in hydraulic, pneumatic, lubrication, steam and refrigerant systems. Inert to most industrial hazards, hydrocarbons (gasoline, diesel fuel, etc.), acids, chemicals, solvents and gases.

Available In: 50 ml., 250 ml. tubes.



Anaerobic Sealing Compound (standard grade) is an excellent general purpose pipe sealant that provides an instant permanent seal, that will cure in the absence of air, locking threads securely.

Part Number	Description	List Price
22050	Anaerobic Sealing Compound 50 ml. Tube	\$24.53
22250	Anaerobic Sealing Compound 250 ml. Tube	\$58.02

Features and Benefits:

- Superior to other anaerobic sealants
- Prevents vibration loosening
- Does not plug up filters, valves, or gauges
- Seals pipes-including 3" and larger
- Lubricates, prevents corrosion, seizing and galling
- Low locking strength provides for disassembly
- Not volatile or flammable UL approved
- Allows easy adjustment up to 16 hours after assembly



Anaerobic-HD Sealing Compound (stainless steel grade) is specifically made for stainless steel alloy fittings. Heavy-Duty and faster curing than standard grade anaerobic.

Part Number	Description	List Price
22151	Anaerobic Sealing Compound Heavy-Duty 50 ml. Tube	\$24.53
22152	Anaerobic Sealing Compound Heavy-Duty 250 ml. Tube	\$92.26



PTFE Spray Light-Coat (Dry Lubricant and Release Agent)

Features and Benefits:

- Dry film lubricant and release agent
- Not affected by most chemicals and solvents
- Low coefficient of friction (.02)
- Will not react or combine with process materials
- Fast drying and non-staining
- Will not freeze and withstands 500°F (260°C)

PTFE Spray Light-Coat is a multi-purpose PTFE powder lubricant that is non-staining and non-oily and will not collect dirt or dust. It is chemically inert, and is an excellent mold release agent. This fast drying dry film lubricant has a very low coefficient of friction which can solve many friction problems.

Applications: Light duty gears, bearings, rollers, sliding surfaces, as a mold release, textile and paper machinery where cleanliness is critical.

Available In: 10 oz. Aerosol CFC Free (P/N 17075)



Part Number	Description	List Price
17075	PTFE Spray Light-Coat	\$18.40

RTV Silicone Adhesive / Sealant / Instant Gasket

Features and Benefits:

- Superior caulking, bonding and sealing qualities
- Easier to use than other gasketing methods
- Fills in small surface defects
- Resists chemicals, temperature extremes, weather, vibration, moisture, and ozone
- Will not sag, run off or shrink
- Functions in hundreds of applications as a specialty sealant and flexible adhesive
- Excellent non-conducting characteristics



100% RTV Silicone is a multi-purpose, single component adhesive sealant which quickly adheres to most surfaces. It cures in 24 hours to provide a tough, resilient silicone rubber to handle hundreds of applications. **100% RTV Silicone** can be used for gasketing, sealing, bonding, insulating, caulking, encapsulating and coating. This flexible material resists shrinking, cracking, weather, ozone, chemicals, moisture, vibration and extreme temperatures ranging from -85° F to +450° F (-65° C) to +232° C) (Hi-Temp Red to 500° F (260° C) continuous and 600° F intermittent exposure).

Applications Include: RTV Silicone is great for making replacements of custom gaskets and seals for all types of motors, transmissions, gear housing, pumps, power tools, machinery, etc. It's better than conventional gaskets because it fills in surface irregularities. **As a Sealer and Caulk-**Use it to seal heating and ventilating ducts. RTV silicone seals cracks or gaps around windows, vents, doors, machinery, truck cabs and trailers, fixtures, lights, walls, bathtubs, sinks, etc. It can be used to waterproof electrical connections and boxes. It will seal out water from compartments in machinery, as well as seal holes where wire tubing or refrigeration lines run through walls. **As a Flexible Adhesive,** versatile RTV Silicone will easily bond dissimilar materials. Provides excellent adhesion to clean metal, glass, most types of wood, ceramic, porcelain, painted and many plastic surfaces. Attach name plates and signs to equipment, walls, doors, windows, (interior or exterior). It will bond gaskets in heating and refrigeration units. **As a Specialty Sealant,** RTV Silicone can be used to seal or coat components exposed to moisture, vibration, shock, certain fuels, oils, solvents, chemicals and corrosives for a long period of time. This product can be used as a formed-in-place gasket where irregular shapes and harsh conditions reject ordinary seals. It is also effective for repairing electrical insulation, sealing insulators and entrance ports to transformers. **RTV Silicone** is USDA, UL and NSF approved. Meets FDA reg. No. 21 CFR 177-2600 and MIL-A-46106 Specs. The equivalent of Dow Corning 732 & 736, GM, Ford and Chrysler Specs.

Available In: A variety of colors and cure types in **patented 8 oz. pressurized containers**, standard 10.3 oz. Cartridges and 3 oz. Tubes.

Part Num.	Description	List Price	Part Num.	Description	List Price
27084	White Silicone Adhesive/Sealant 8 oz.	\$30.19	27086	Clear Silicone Adhesive/Sealant 8 oz.	\$26.19
27104	White Silicone Adhesive/Sealant 10.3 oz.	\$15.00	27106	Clear Silicone Adhesive/Sealant 10.3 oz.	\$15.00
27034	White Silicone Adhesive/Sealant 3 oz.	\$12.19	27036	Clear Silicone Adhesive/Sealant 3 oz.	\$12.19
27085	Red Hi Temp Silicone Adhesive/Sealant 8 oz.	\$26.19	27087	Blue Silicone Adhesive/Sealant 8 oz.	\$26.19
27105	Red Hi Temp Silicone Adhesive/Sealant 10.3 oz.	\$15.00	27107	Blue Silicone Adhesive/Sealant 10.3 oz.	\$15.00
27035	Red Hi Temp Silicone Adhesive/Sealant 3 oz.	\$12.19			

CA-020™ Instant Adhesive

CA-020 Instant Adhesive is a cyanoacrylate adhesive. Ca-020 is a medium viscosity, fast curing product with good elasticity for bonding plastics, metal, rubber, glass and dissimilar materials. It is a versatile adhesive with good thermal, climatic and impact resistance.

Applications include: Electronic equipment including pc boards, connectors and transformers. Plastic cases, rubber fabrication and gaskets, appliances and office equipment.

Available in: 20 gram bottle (p/n 23020).

Features and Benefits:

- Most versatile instant adhesive available
- Fast overall cure speed
- Convenient dispenser bottle with screw cap
- Temperatures -40° F to +176° F (intermittent +250° F)



Part Number	Description	List Price
23020	CA-020™ Instant Adhesive 20 gram Bottle	\$22.21

Ready-Stick™ Epoxy Putty

Ready-stick Epoxy Putty is a hand-mixable adhesive/sealant that hardens like steel in 20 minutes. It will patch holes and cracks, and mend most anything that is broken. Excellent for rebuilding and fabricating parts. An all purpose adhesive for metals, wood, glass, masonry, ceramics and many plastics.

Applications include: Plumbing repair, electrical repair, construction equipment, auto/truck repair, home/shop repair, concrete pools, oil and water tanks, tools, sink and pipe joints, gas tanks & radiators.

Available in: 4 oz. Tube/stick (p/n 34114).

Features and Benefits:

- Ready-stick epoxy allows you the option of breaking off any portion and keeping the unused stick for future use
- Withstands temperatures of -40° F to +250° F
- Sets steel-hard in 20 minutes
- Adhesive bonding to metal, wood, glass and most materials
- Can be tapped, drilled, filed, sanded and painted



Part Number	Description	List Price
34114	Epoxy Putty 4 oz. Tube/Stick	\$25.62

Adhesive Spray

Adhesive Spray is a multi-purpose, pressure-sensitive adhesive designed to form either permanent or temporary bonds between two porous or non-porous materials. Adhesive spray is specially designed for many industrial applications as well as contractor, office, home and hobby use. Adhesive solids are non-toxic, non-irritating and meet requirements for indirect food additives as outlined in Fed. Reg. Paragraphs 121.2507 to 121.2577.

Applications include: Permanent or temporary bonds on paper, cardboard, all types of gaskets, cloth, foil, mylar or acetate sheet, glass, many plastics, urethane foam, leather and foam rubber. Temporary bond eliminates need for tacks or pins, making any surface a bulletin board.

Adhesive spray is used in: Printing plants, advertising agencies, trucking companies and shipping departments, or any industry for sealing packages and applying labels.

Available in: 16 oz. Aerosol (p/n 17066).

*CFC free

Features and Benefits:

- Colorless
- Non-clogging
- Non-toxic solids
- Temperatures to +110 F
- Low soak-in
- Waterproof
- Fast aggressive tack action



Part Number	Description	List Price
17066	Adhesive Spray 16 oz.	\$19.62



All-Purpose 4-Way™ Lubricant & Penetrating Oil

All-Purpose 4-Way is specially formulated to lubricate and penetrate, leaving parts with a protective anti-rust film. This quality lubricant protects metal parts which helps eliminate pounding and breakage during disassembly. All-Purpose 4-Way has no CFC's, chlorinated solvents or silicones.

Applications Include: Frozen nuts & bolts, auto and truck parts/engines, hand tools, farm equipment, marine engines, locks, hinges, fire arms, etc..

Available in : 12 oz. Aerosol

Features and Benefits:

- Penetrates hard to reach places on contact
- Frees and lubricates frozen and rusted parts
- Inhibits rust and corrosion and protects metal surfaces
- Displaces moisture
- Cleans and degreases tools and equipment
- Unique aerosol can be sprayed in any position



Part Number	Description	List Price
17061	All-Purpose 4-Way Penetrant / Lubricant 12 oz. Aerosol	\$13.68

A.S.T. Penetrant II™

A.S.T. Penetrant II is a heavy-duty, industrial strength penetrant. It quickly penetrates deep through rust, scale and corrosion on frozen nuts and bolts, threaded connections, machinery and tools. Frees metal parts faster than all ordinary penetrant / lubricants. A.s.t. Penetrant II has no cfc's chlorinated solvents or silicones.

Applications include: Heavily rusted and corroded nuts and bolts, heavy equipment, farm and marine equipment, pumps, valves and couplings. Also excellent for rusted hand tools, machinery linkages, pipe joints and screwed connections.

Available in: 12 oz. Aerosol *CFC free

Features and Benefits:

- Deep penetrating action.
- Quickly attacks heavy rust, corrosion and mineral deposits.
- Frees metal parts faster than other penetrants.
- Reduces costs in time and labor.
- Eliminates excessive parts breakage.
- Jet stream delivery allows precision spraying.



Part Number	Description	List Price
17063	A.S.T. Penetrant II 12 oz.	\$14.81

Chain and Cable Lube

Chain and Cable Lube is a heavy duty lubricant for reducing friction and wear. It is a mixture of penetrants, anti-oxidants, oils and grease; plus molybdenum disulfide which creeps into chain components and cable strands to provide excellent lubrication and rust protection. This lubricant forms a non-gumming thin film providing maximum lubrication and protection under severe conditions.

Applications include: Roller chains and drives, hoists and conveyors, wire rope and cable, chain saws, sprockets, land and roller assemblies, hinges and many outdoor/indoor applications.

Available in: 16 oz. Aerosol *CFC free

Features and Benefits:

- Multi-purpose, heavy-duty lubricant
- Contains molybdenum disulfide for added wear resistance
- Thick foam penetrates and clings to all surfaces
- Provides a non-gumming protective film
- Can be applied while machinery is running
- Displaces water, eliminating moisture & preventing corrosion



Part Number	Description	List Price
17040	Chain & Cable Lubricant 16 oz.	\$24.81

Silicone Lubricant (Industrial Grade)

Silicone Lubricant Industrial Grade is a dry non-staining lubricant and release agent that makes everything slide easier with no greasy mess. This non-toxic, odorless and colorless lubricant allows unlimited uses. A universal dry lubricant that waterproofs, protects and rustproof almost any surface. High viscous silicone. Resists breakdown under heavy loads or mechanical shear.

Applications include: Refrigeration equipment, plastic and rubber molds, doors, windows, locks, guides, rails, electronic equipment, conveyors, hinges, squeaky springs, lawn mower blades, molding, casting and stamping dies, aircraft, autos and boats, business machines and construction equipment.

Available in: 10 oz. Aerosol *CFC free

Features and Benefits:

- 100% pure silicone
- Not affected by temperature extreme: -40° F to +400° F (40° C to +204° C)
- Provides a non-tacky film of lubrication
- Provides excellent release properties for metallic and non-metallic surfaces



Part Number	Description	List Price
17067	Silicone Lubricant Industrial Grade 10 oz.	\$15.09



Belt Dressing

Belt dressing is designed for all types of belt drives and will improve performance under the most severe conditions. It will waterproof and preserve all types of belts and will not glaze or cause buildup.

Belt dressing does not contain rosin, silicones, sticky oils, varnishes or other harmful substances.

Applications include: Practically all flat, round or v-style belts. Works great on all industrial belt drives including compressors, pumps, generators, auto and marine engine belts, canvas and other fabric belts.

Available in: 12-3/4 oz. Aerosol *CFC free

Features and benefits:

- Can be applied while belt is moving and motor is running
- For both indoor and outdoor use
- Eliminates slippage on incline conveyor belts
- Prolongs life of all belts
- Prevents rotting and deterioration even under severe outdoor conditions
- Anti-slip agent increases power without gumming



Part Number	Description	List Price
17030	Belt Dressing 11-1/4 oz. Aerosol	\$13.02

Zinc Cold Galvanizing Spray

Zinc Cold Galvanizing Spray is a convenient smooth-flowing compound that stops rust, rust creepage and corrosion on any ferrous or non-ferrous metal by providing a zinc-rich coating, which electrochemically bonds with metal resulting in a protective, self-forming oxide. Zinc cold galvanizing spray meets or exceeds the following military specifications: MIL-p-46105 weld thru primer. U.s. Navy galvanizing repair specification MIL-p-21034. U.s. Air force MIL-t-26433 for towers (temperate and arctic zones). Also MIL-p-26915a.

Applications include: Heating and air conditioning systems, weldments, road and farm equipment, bridges, boat and marine equipment, fencing, storage tanks, metal signs, gutters and more.

Available in: 15 oz. Aerosol *CFC free

Features and Benefits:

- Contains 95% pure zinc for a rich, protective coating
- Prevents rust and corrosion for up to 3 years
- Exceptional heat resistance - continuous dry heat up to 750° F(400° C), short period heat up to 1000° F (538° C), and water temperature above boiling
- Dries quickly to an attractive gray color and be painted over if desired



Part Number	Description	List Price
17045	Zinc Cold Galvanizing Compound 15 oz. Aerosol	\$25.06

Anaerobic Thread Lockers



50 or 250mL

Part Number	Description	List Price
*22542	An excellent sealant for straight metal threads up to 1" diameter created to withstand hydraulic system pressures. Resistance to high temp, water, and non-polar solvents.	\$41.23
*22543	Same as 22542 but five times more (250mL)	\$126.51
39092	General purpose, low viscosity, retaining compound, green color for press-fit assemblies MIL-R-46082B, Type I 1.69 oz.	\$42.64
39422	Medium strength, thread locking, removable, adhesive/sealant, blue color for bolts and screws up to 3/4". MIL-S-46163A, Type II 1.69 oz.	\$41.23
39902	Penetrating/wicking, medium/high strength, adhesive/sealant, green color for pre-assembled fasteners. MIL-S-46163A, Type III. Grade R 1.69 oz..	\$41.23
39712	High strength, adhesive sealant, green color for bolt/stud locking MIL-S-46163A, Type I. Grade K 1.69 oz.	\$41.23

* For Hydraulic Use

Anti-Seize Marine Industry Kit

Marine Industry Kit Includes

- MARINE GRADE NON METALLIC ANTI-SEIZE COMPOUND
- METAL-FREE 2000™ - LUBRICATING COMPOUND
- TFE™ - PIPE THREAD SEALANT w/PTFE
- MOLY AP™ - METAL ASSEMBLY PASTE
- SG-ONE™ - LIGHT CONSISTENCY SILICONE GREASE
- AST-GASKET MAKER™ - FLEXIBLE ANAEROBIC GASKET
- READY-STICK™ w/STEEL - STEEL REINFORCED EPOXY PUTTY
- AST-SEAL™ HD - ANAEROBIC SS PIPE SEALANT w/PTFE
- AST-LOCK™ 71HS - BOLT/STUD LOCKING ADHESIVE/SEALANT
- POLY-TEMP™ SSG - SS GRADE THREAD SEAL TAPE
- PTFE JOINT SEALANT - 100% PTFE/UHF GASKET

Part Number	Description	List Price
MIK1200	Marine Industry Kit	\$199.94



Anti-Seize Industrial Maintenance Kit

Industrial Maintenance Kit Includes

- ANTI-SEIZE SPECIAL - LUBRICATING COMPOUND
- METAL-FREE 2000™ - LUBRICATING COMPOUND
- ALUMINUM PLATE™ - ANTI-SEIZE COMPOUND
- COP-GRAF™ - ANTI-SEIZE COMPOUND
- TFE™ - PIPE THREAD SEALANT w/PTFE
- S'MOOTH™ - THREAD SEALANT w/PTFE
- SG-ONE™ - LIGHT CONSISTENCY SILICONE GREASE
- PURE WHITE™ - FOOD GRADE ANTI-SEIZE w/PTFE
- AST-SEAL™ STD - ANAEROBIC PIPE SEALANT w/PTFE
- POLY-TEMP™ - PTFE TAPE MEDIUM DENSITY
- LOW DENSITY PTFE - THREAD SEAL TAPE

Part Number	Description	List Price
IMK1200	Industrial Maintenance Kit	\$199.94



AST Gasket Maker

AST Gasket Maker is an anaerobic gasket product designed to replace pre-cut gaskets, or can be used with pre cut gaskets to enhance their sealing ability. **AST Gasket Maker** cures and polymerizes in the absence of air and presence of metal to form a strong leak proof seal. It can fill imperfections in surfaces up to 0.01" and provides an instant low pressure seal.

Available in: 50mL (1.69 FLoz)

Part Number	Description	List Price
50152	Gasket Maker 50mL	\$34.91

Cleaning and Application: For best results make sure the bond surface areas are clean of all foreign materials and free of grease or other lubricants or cleaning solvents. Apply **AST Gasket Maker** onto one surface of the flange or joint. Tighten the flanges using the recommended torque and torque pattern as soon as possible after assembly.



AST Rubber Coat

AST Rubber Coat is a rubberized undercoating and spray sealer in an easy to use aerosol can. When dry, it forms a long lasting barrier that seeps into small cracks to create a waterproof seal that is durable even in extreme temperatures.

AST Rubber Coat forms a protective barrier that seals out moisture, deadens noise, and forms a protective barrier to prevent further corrosion.

Applications include: Automotive undercoating, truck chassis, roof flashings, duct sealer, foundation sealer, marine applications, drainpipes, and many others.

Available in: 16oz aerosol (453g)

Part Number	Description	List Price
17048	Rubber Coat Aerosol 16oz	\$22.45

Cleaning: For best results remove any excessive rust from your project using wire brush, media blasting, or pressure washing. Shake the **AST Rubber Coat** can for up to 1 minute. It's best to apply several light coats rather than 1 thick coat.





SLICKON Flow-Lube

SLICKON Flow-Lube is an advanced blend of high performance, low viscosity petroleum oils that provide long lasting lubrication for moving or sliding parts. It contains special wetting agents that help to penetrate grime so the lubricant maintains contact with the surface.

Applications: Conveyors, forklifts, hand truck and cartwheels, door hinges, loading dock doors, truck doors, machinery, tools, office equipment, shredders, deskdrawers, locks, cables, gears, landscaping equipment, snow removal, recreation gear, and much more.

Available in: 15oz Aerosol (425g)

Features and Benefits:

- Long lasting lubrication
- Frees sticky mechanisms
- Contains P.T.F.E for advanced lubrication
- Extends equipment life
- Protects against rust and corrosion
- Does not contain silicones or wax
- Ideal for humid environments
- Extension tube for pinpoint lubrications



Part Number	Description	List Price
17064	SlickOn Flow Lube 15oz Aerosol	\$17.36

Graphite-Spray

Graphite-Spray contains a high purity graphite along with an organic binder that will adhere the coating to most surfaces. This leaves a dry, tack-free film of highly lubricous graphite which will lubricate and reduce friction in parts so they slide or rotate easily.

Applications: Mold release, foundry molds, hinges and hinge pins, drawer slides, chains, rollers, gears, slides, sprockets, nuts and bolts, automotive and industrial gaskets, plant machinery, and much more.

Available in: 12oz aerosol (340g)

Features and Benefits:

- Dry film of highly lubricous graphite
- Parts slide easily, reduces friction
- Fast drying
- Dry film lubricant does not attract dirt
- Will effectively lubricate up to 18,000 psi
- Hardens to a tough long lasting tack free film



Part Number	Description	List Price
17041	Graphite Aerosol Spray 12oz	\$16.42

Rust Treatment

Rust Treatment is a rust converter designed to be directly applied to rusty surfaces to convert residual rust on steel surfaces to a harmless and adherant chemical compound.

Application: ¹Can be applied to all rusting steel and iron. ²Can be applied using a brush or roller.

Available in: 11oz aerosol (312g)

Features & Benefits

- Stops rusting
- Protects surfaces to resist the effects of weather
- Does not require primer coat before painting
- Eliminate lengthy surface preparations
- Does not leave a powdery surface
- Will not peel or crack
- Long term protection on steel and iron



Part Number	Description	List Price
15005	Rust Treatment Aerosol Spray 11oz	\$15.19

Metal Parts Protector Light Coat

Metal Parts Protector Light Coat is a rust and corrosion preventative coating in an aerosol can. It will protect your parts during storage or transportation. It protects parts from weather, humidity, chemical vapors, and salt exposure.

Application: Bare metal, battery terminals and cables, cables and chains, forklifts, tractors, metal stampings, molds, tools, guns and rifles in storage. Marine use to protect parts against salt spray and humidity damage.

Available in: 11oz aerosol (312g)

Features & Benefits

- Protects for up to 2 years
- Penetrates to displace moisture
- Prevents rust and corrosion
- Guards against salt damage
- Coating is flexible and resilient
- Silicone free
- No chlorinated solvents



Part Number	Description	List Price
17043	Metal Parts Protector Aerosol Spray 11oz	\$14.15



Hand and Tool Wipes

Hand and Tool Wipes are designed for use in industrial and manufacturing settings. Each towel is pre-moistened with a powerful cleaning formula capable of cleaning hard working hands as well as non-porous surfaces. Each towel is made from an abrasive, yet non-scratching fabric that helps lift away heavy deposits of grime and dirt of hands and surfaces.

Directions: ¹Scrub greasy surfaces with abrasive side of towel until the grease is loosened, then use the smooth side to wipe the surface clean. ²Discard used towel.

Available in: 70 count

Part Number	Description	List Price
49370	Hand and Tool Wipes 70 count	\$40.00

Features and Benefits:

- High powered multipurpose cleaner
- Uses include: industrial, plumbing, printing, manufacturing, construction, painting, transportation, maintenance, marine, and much more



AST-PVR Heavy Duty Paint and Varnish Remover

AST PVR is a methylene chloride, thick jellied stripper that quickly dissolves paint, resin cements, carbon deposits, dried oils and greases, and much more. It saves time and money by eliminating damage caused by excessive scraping, grinding and chiseling, and media blasting. The jellied consistency slows the evaporation rate, allowing deep penetration.

Directions: ¹Protect any painted surfaces where you do not want the paint removed. ²Spray on the surface you want to remove and wait for it to blister. ³Using a soft edge scraper, removed the blistered material.

Available in: 18oz (510g) Aerosol

Part Number	Description	List Price
17052	Varnish Remover Aerosol Spray 18oz	\$18.68

Features & Benefits

- Jellied consistency stays where it's sprayed
- Helps to reduce surface damage
- Non corrosive
- Dissolves asphalt, carbon, and other residues
- Easily tackles those hard to remove deposits
- Removes burned on grease.



Sof-Set Premium General Purpose Pipe Thread Sealant

Sof-Set is a soft setting, pliable, slow drying, thread sealing compound. This slow drying feature allows the user to keep the can open during application without fear of solvent loss.

Applications: Threaded connections for water, steam, LP and natural gas, refrigerants, fuel oils, hydraulic oil, diluted acids and caustics. Use on all metal and PVC threaded pipe connections found in industrial, commercial, and residential systems.

Features & Benefits

- Dries to a soft set
- Corrosion inhibiting
- Non-seizing to allow disassembly
- Non-metallic solids, no heavy metals
- Non-dripping
- Can be applied to newly cut hot threads
- Withstands temps to 400°F and pressures to 10,000 psi (liquid) & 2,600 psi (gas)

Part Number	Description	List Price
29010	1/2 PT Brush Top	\$19.81
29018	1 PT Brush Top	\$31.51
29026	1 G Brush Top	\$53.58



Tuf-Set High Performance Pipe Thread Sealant

Tuf-Set is a high performance pipe thread sealant specifically designed for threaded connections commonly used in heating, ventilation and refrigeration, HVAC, commercial and residential plumbing, and industrial applications. It is fast drying, firm setting, and will stay flexible to resist vibration loosening

Applications: Refrigerant lines, all plumbing pipe connections, fuel and kerosene lines, hydraulic systems, potable water lines, natural gas, steam, and propane lines, and much more.

Features & Benefits

- Smooth consistency
- Fast drying, firm setting
- Non-toxic, no heavy metal fillers
- Excellent corrosion protection
- Broad chemical resistance
- Will not run or drip after application
- Allows for easy disassembly
- Withstands temps to 400°F and pressures to 10,000 psi (liquid).

Part Number	Description	List Price
56004	1/4 PT Brush Top	\$14.91
56008	1/2 PT Brush Top	\$26.04
56018	1 PT Brush Top	\$44.72
56026	1 G Brush Top	\$73.58



Thermometers

Standard Pocket Thermometer

Our standard pocket thermometer have a 1" dial, 304SS hermetically sealed case, 304SS 0.04 mm diameter, 5" long stem, and plastic lens. The accuracy is + 1.5% of scale range. Each unit comes with a protective case and SS clip, that allows it to be safely carried in your pocket and be used to hold the thermometer in the media to be tested.



Part Number	Description and Range	List Price
PT1220	1" dial, 5" stem, 0/220 F°	\$5.19
PT1550	1" dial, 5" stem, 50/550 F°	\$5.19



3" Bi-Metal Thermometer Stainless Case

Part Number	Temperature x Stem (in.)	List Price
3250250	0-250°F X 2 1/2"	\$15.57
3500250	50-500°F X 2 1/2"	\$18.77
3250400	0- 250°F X 4"	\$15.57
3500400	50-500°F X 4"	\$18.77
3250600	0-250°F X 6"	\$15.57
3500600	50-500°F X 6"	\$18.77
3250900	0-250°F X 9"	\$17.26
3500900	50-500°F X 9"	\$18.77

Process connection: 1/2" NPT

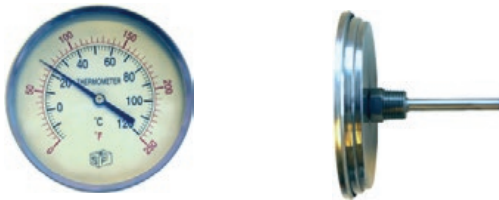

5" Bi-Metal Thermometer Stainless case

Part Number	Temperature x Stem (in.)	List Price
5250250	0-250°F X 2 1/2"	\$25.00
5500250	50-500°F X 2 1/2"	\$28.21
5250400	0- 250°F X 4"	\$25.00
5500400	50-500°F X 4"	\$28.21
5250600	0-250°F X 6"	\$25.00
5500600	50-500°F X 6"	\$28.21
5250900	0-250°F X 9"	\$25.00
5500900	50-500°F X 9"	\$28.21

Process connection: 1/2" NPT



5" Adjustable Stainless Case

Part Number	Temperature x Stem (IN.)	List Price
5250250ADJ	0-250°F X 2 1/2"	\$43.87
5500250ADJ	50-500°F X 2 1/2"	\$43.87
5250400ADJ	0- 250°F X 4"	\$43.87
5500400ADJ	50-500°F X 4"	\$47.55
5250600ADJ	0-250°F X 6"	\$43.87
5500600ADJ	50-500°F X 6"	\$47.55
5250900ADJ	0-250°F X 9"	\$43.87
5500900ADJ	50-500°F X 9"	\$47.55

Process connection: 1/2" NPT

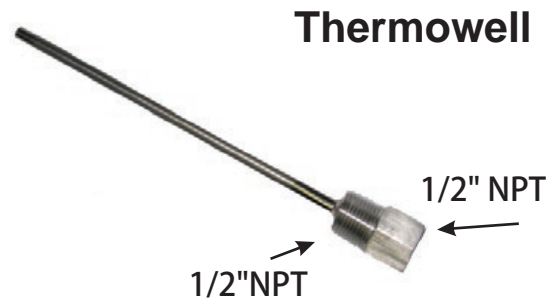

Thermowell

Thermowell				
Size	304 Stainless Steel	List Price	316 Stainless Steel	List Price
2-1/2"	T304250	\$8.21	T316250	\$11.51
4"	T304400	\$11.13	T316400	\$14.62
6"	T304600	\$12.26	T316600	\$17.64
9"	T304900	\$15.47	T316900	\$22.08



41 Series - Polished Brass

Note: Parts may not look exactly like pictures.

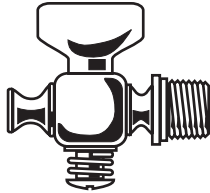

**Tee Handle
Round Shoulder**

Part Number	Size	List Price
4106001	1/8"	\$5.58
4107001	1/4"	\$6.04

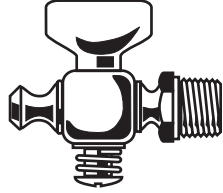

**Tee Handle
Hexagon Shoulder**

Part Number	Size	List Price
4108001	3/8"	\$8.28
4109001	1/2"	\$10.64

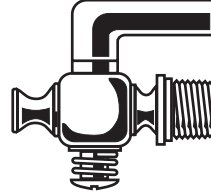

**Lever Handle
Round Shoulder**

Part Number	Size	List Price
4112001	1/8"	\$5.94
4113001	1/4"	\$6.42

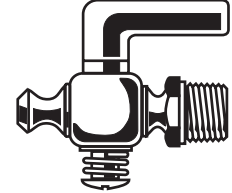

**Lever Handle
Hexagon Shoulder**

Part Number	Size	List Price
4114001	3/8"	\$9.32
4115001	1/2"	\$11.70

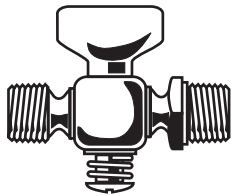

**Tee Handle
Double Male**

Part Number	Size	List Price
4118001	1/8"	\$5.58
4119001	1/4"	\$6.04
4120301	3/8"	\$8.57
4121001	1/2"	\$10.94

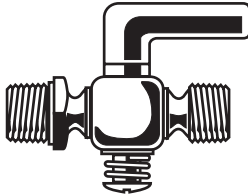

**Lever Handle
Double Male**

Part Number	Size	List Price
4122001	1/8"	\$5.94
4123001	1/4"	\$6.42
4124001	3/8"	\$9.32
4125101	1/2"	\$11.70

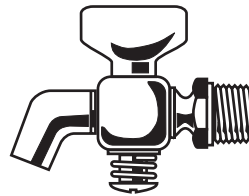

**Tee Handle
Bibb Nose**

Part Number	Size	List Price
4126001	1/8"	\$5.58
4127001	1/4"	\$6.04
4128001	3/8"	\$8.57
4133001	1/2"	\$10.94

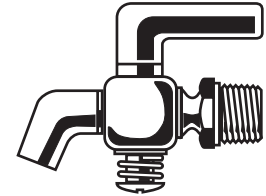

**Lever Handle
Bibb Nose**

Part Number	Size	List Price
4129001	1/8"	\$5.94
4130001	1/4"	\$6.42
4131001	3/8"	\$9.32
4132001	1/2"	\$9.38

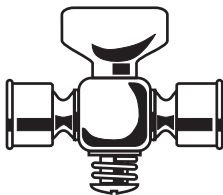

**Tee Handle
Double Female**

Part Number	Size	List Price
4137001	1/8"	\$5.58
4138001	1/4"	\$6.04
4139001	3/8"	\$8.57
4139101	1/2"	\$10.94

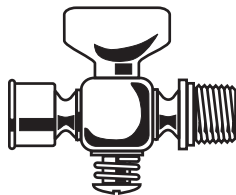

**Tee Handle
Female X Male**

Part Number	Size	List Price
4140001	1/8"	\$5.94
4141001	1/4"	\$6.42
4142001	3/8"	\$9.32
4142101	1/2"	\$11.70

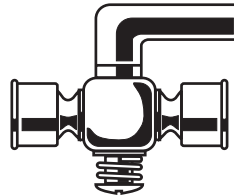

**Lever Handle
Double Female**

Part Number	Size	List Price
4143001	1/8"	\$5.58
4144001	1/4"	\$6.04
4145001	3/8"	\$8.57
4145101	1/2"	\$10.94

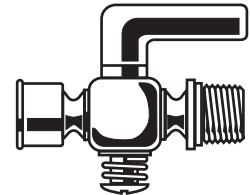

**Lever Handle
Female X Male**

Part Number	Size	List Price
4146001	1/8"	\$5.94
4147001	1/4"	\$6.42
4148001	3/8"	\$9.32
4148101	1/2"	\$11.70





41 Series - Polished Brass

Note: Parts may not look exactly like pictures.

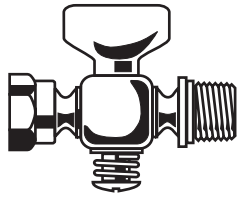

Hexagon Shoulder Tee Handle - Female X Male

Part Number	Size	List Price
4149001	1/8"	\$5.58
4150001	1/4"	\$6.04
4151001	3/8"	\$8.57
4151101	1/2"	\$10.94

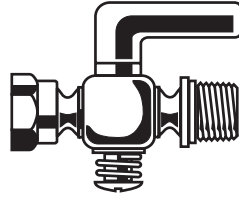

Hexagon Shoulder Lever Handle - Female X Male

Part Number	Size	List Price
4152001	1/8"	\$5.94
4153001	1/4"	\$6.42
4154001	3/8"	\$9.32
4154101	1/2"	\$11.70

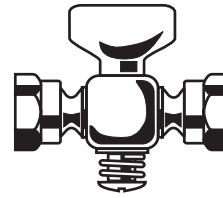

Hexagon Shoulder Tee Handle - Double Female

Part Number	Size	List Price
4155001	1/8"	\$5.58
4156001	1/4"	\$6.04
4157001	3/8"	\$8.57
4157101	1/2"	\$10.94

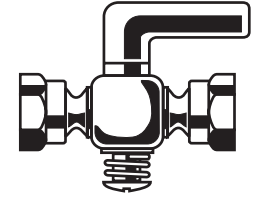

Hexagon Shoulder Lever Handle - Double Female

Part Number	Size	List Price
41-580-01	1/8"	\$5.94
41-590-01	1/4"	\$6.42
41-600-01	3/8"	\$9.32
41-601-01	1/2"	\$11.70

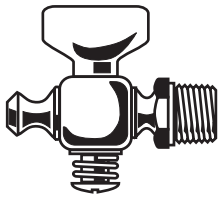

Hexagon Shoulder Tee Handle - Straight Nose

Part Number	Size	List Price
4163001	1/8"	\$5.58
4164001	1/4"	\$6.04

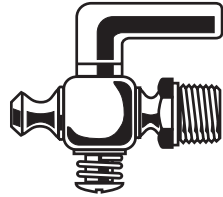

Hexagon Shoulder Lever Handle - Straight Nose

Part Number	Size	List Price
4165001	1/8"	\$5.94
4166001	1/4"	\$6.42

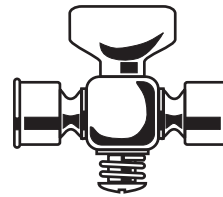

Double Female - Heavy Pattern - Tee Handle

Part Number	Size	List Price
4110201	1/4"	\$23.04

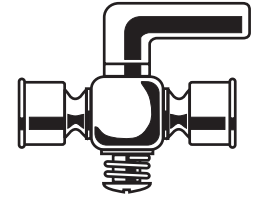

Double Female - Heavy Pattern - Lever Handle

Part Number	Size	List Price
41-103-01	1/4"	\$21.98

Gas Service Cocks

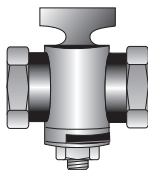

Tee Head Gas Service Cock
Nut & Washer Bottom with Check

Part Number	Size	List Price
52-101-01	1/4"	\$32.45
52-102-01	3/8"	\$32.45
52-103-01	1/2"	\$32.13
52-104-01	3/4"	\$36.53
52-105-01	1"	\$45.28

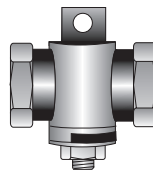

Flat Head Gas Service Cock
Nut & Washer Bottom with Check

Part Number	Size	List Price
52-201-01	1/4"	\$33.19
52-202-01	3/8"	\$33.19
52-203-01	1/2"	\$32.45
52-204-01	3/4"	\$36.53
52-205-01	1"	\$46.79

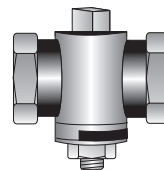

Square Head Gas Service Cock
Nut & Washer Bottom with Check

Part Number	Size	List Price
52-301-01	1/4"	\$33.64
52-302-01	3/8"	\$33.64
52-303-01	1/2"	\$32.45
52-304-01	3/4"	\$45.58
52-305-01	1"	\$45.58

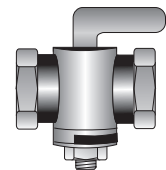

Lever Head Gas Service Cock
Nut & Washer Bottom with Check

Part Number	Size	List Price
52-401-01	1/4"	\$32.45
52-402-01	3/8"	\$32.45
52-403-01	1/2"	\$32.45
52-404-01	3/4"	\$35.98
52-405-01	1"	\$43.53



SEAL FAST GAUGES



Heavy Duty Gauges Liquid Filled



Applications: Used in hydraulic and pneumatic systems, compressors, regulator and industry machine, and suitable for fluid medium or gaseous which does not clog connection port or corrode stainless steel. Can use for severe service conditions where pulsation or vibration exist. Premium quality and long life.



Accuracy: $\pm 1.6\%$ of full scale

2-1/2" Face x 1/4" LM		
Part Number	Range psi / kpa	List Price
118AL25N4P30	30 psi / 200 kpa	\$27.92
118AL25N4P60	60 psi / 400 kpa	\$27.92
118AL25N4P100	100 psi / 700 kpa	\$27.92
118AL25N4P160	160 psi / 1,100 kpa	\$27.92
118AL25N4P200	200 psi / 1,400 kpa	\$27.92
118AL25N4P300	300 psi / 2,100 kpa	\$27.92
118AL25N4P400	400 psi / 2,200 kpa	\$27.92
118AL25N4P600	600 psi / 4,000 kpa	\$27.92
118AL25N4P1000	1,000 psi / 7,000 kpa	\$27.92
118AL25N4P1500	1,500 psi / 10,000 kpa	\$27.92
118AL25N4P2000	2,000 psi / 14,000 kpa	\$27.92
118AL25N4P3000	3,000 psi / 21,000 kpa	\$27.92
118AL25N4P5000	5,000 psi / 35,000 kpa	\$27.92
118AL25N4P10000	10,000 psi / 70,000 kpa	\$27.92

All Gauges This Page

Case: Stainless Steel
Glass: Safety Glass
Ring: Stainless Bonnet Ring
Internal: Stainless Steel
Bourdon Tube: 30 to 600 psi c-type
1000 to 10,000 psi coil type

Abbreviations

LM=Lower mount
Liquid filling: Glycerine
Temperature Range: -4°F to 140°F

Accuracy: $\pm 1.0\%$ of full scale

Accuracy: $\pm 1.0\%$ of full scale

6" Face x 1/2" LM		
Part Number	Range psi / kpa	List Price
118AL60N2P30	30 psi / 200 kpa	\$100.94
118AL60N2P60	60 psi / 400 kpa	\$100.94
118AL60N2P100	100 psi / 700 kpa	\$100.94
118AL60N2P160	160 psi / 1,100 kpa	\$100.94
118AL60N2P200	200 psi / 1,400 kpa	\$100.94
118AL60N2P300	300 psi / 2,100 kpa	\$100.94
118AL60N2P400	400 psi / 2,200 kpa	\$100.94
118AL60N2P600	600 psi / 4,000 kpa	\$100.94
118AL60N2P1000	1,000 psi / 7,000 kpa	\$100.94
118AL60N2P1500	1,500 psi / 10,000 kpa	\$100.94
118AL60N2P2000	2,000 psi / 14,000 kpa	\$100.94
118AL60N2P3000	3,000 psi / 21,000 kpa	\$100.94
118AL60N2P5000	5,000 psi / 35,000 kpa	\$100.94
118AL60N2P10000	10,000 psi / 70,000 kpa	\$100.94

4" Face x 1/2" LM		
Part Number	Range psi / kpa	List Price
118AL40N2P30	30 psi / 200 kpa	\$62.45
118AL40N2P60	60 psi / 400 kpa	\$62.45
118AL40N2P100	100 psi / 700 kpa	\$62.45
118AL40N2P160	160 psi / 1,100 kpa	\$62.45
118AL40N2P200	200 psi / 1,400 kpa	\$62.45
118AL40N2P300	300 psi / 2,100 kpa	\$62.45
118AL40N2P400	400 psi / 2,200 kpa	\$62.45
118AL40N2P600	600 psi / 4,000 kpa	\$62.45
118AL40N2P1000	1,000 psi / 7,000 kpa	\$62.45
118AL40N2P1500	1,500 psi / 10,000 kpa	\$62.45
118AL40N2P2000	2,000 psi / 14,000 kpa	\$62.45
118AL40N2P3000	3,000 psi / 21,000 kpa	\$62.45
118AL40N2P5000	5,000 psi / 35,000 kpa	\$62.45
118AL40N2P10000	10,000 psi / 70,000 kpa	\$62.45



SEAL FAST GAUGES

Pressure & Vacuum Gauges

Abbreviations:

LM=Lower mount
 CBM=Center back mount
 UC=U-Clamp (for panel mount)
 Accuracy: $\pm 3/2/3\%$ of span
 Temperature Range: -10°F to 150°F

All Gauges This Page

Case: Black Steel
 Glass: Glass
 Ring: Chrome Plated Steel
 Pointer And Dial: Aluminum
 Internal: Copper Alloy
 Connection: Brass



E

1 1/2" Face x 1/8" Bottom-Steel Case LM		
Part Number	Range psi / kpa	List Price
G15151	15 psi / 103 kpa	\$3.77
G15301	30 psi / 200 kpa	\$3.68
G15601	60 psi / 400 kpa	\$3.68
G151001	100 psi / 700 kpa	\$3.68
G151601	160 psi / 1,100 kpa	\$3.68
G152001	200 psi / 1,400 kpa	\$3.68

1 1/2" Face x 1/8" Back-Steel Case CBM		
Part Number	Range psi / kpa	List Price
G15302V	Vacuum 30" Hg	\$3.87
G15152	15 psi / 103 kpa	\$3.87
G15302	30 psi / 200 kpa	\$3.77
G15602	60 psi / 400 kpa	\$3.77
G151002	100 psi / 700 kpa	\$3.77
G151602	160 psi / 1,100 kpa	\$3.77
G152002	200 psi / 1,400 kpa	\$3.77



1 1/2" Face x 1/8" Back-Steel Case UC		
Part Number	Range psi / kpa	List Price
G15302UV	Vacuum 30" Hg	\$4.96
G15152U	15 psi / 103 kpa	\$4.96
G15302U	30 psi / 200 kpa	\$4.89
G15602U	60 psi / 400 kpa	\$4.89
G151002U	100 psi / 700 kpa	\$4.89
G152002U	200 psi / 1,400 kpa	\$4.89

2" Face x 1/4" Bottom-Steel Case LM		
Part Number	Range psi/kpa	List Price
G20151	15 psi / 103 kpa	\$4.17
G20301	30 psi / 200 kpa	\$4.17
G20601	60 psi / 400 kpa	\$4.08
G201001	100 psi / 700 kpa	\$4.08
G201601	160 psi / 1,100 kpa	\$4.08
G202001	200 psi / 1,400 kpa	\$4.08
G203001	300 psi / 2,100 kpa	\$4.08
G204001	400 psi / 2,800 kpa	\$4.08
G206001	600 psi / 4,000 kpa	\$4.08

Brass Connection



2" Face x 1/4" Back-Steel Case CBM		
Part Number	Range psi / kpa	List Price
G20152	15 psi / 103 kpa	\$4.28
G20302	30 psi / 200 kpa	\$4.28
G20602	60 psi / 400 kpa	\$4.21
G201002	100 psi / 700 kpa	\$4.21
G201602	160 psi / 1,100 kpa	\$4.21
G202002	200 psi / 1,400 kpa	\$4.21
G203002	300 psi / 2,100 kpa	\$4.21
G204002	400 psi / 2,200 kpa	\$4.21
G206002	600 psi / 4,000 kpa	\$4.21

2" Face x 1/4" Back-Steel Case UC		
Part Number	Range psi / kpa	List Price
G20302UV	Vacuum 30" Hg	\$5.34
G20152U	15 psi / 103 kpa	\$5.34
G20302U	30 psi / 200 kpa	\$5.26
G20602U	60 psi / 400 kpa	\$5.26
G201002U	100 psi / 700 kpa	\$5.26
G201602U	160 psi / 1,100 kpa	\$5.26
G202002U	200 psi / 1,400 kpa	\$5.26
G203002U	300 psi / 2,100 kpa	\$5.26
G204002U	400 psi / 2,200 kpa	\$5.26
G206002U	600 psi / 4,000 kpa	\$5.26



SEAL FAST GAUGES

Pressure & Vacuum Gauges

All Gauges This Page

Case: Black Steel
 Glass: Glass
 Ring: Chrome Plated Steel
 Pointer And Dial: Aluminum
 Internal: Copper Alloy
 Connection: Brass
 Temperature Range: -10°F to 150°F

Abbreviations

LM=Lower mount
 CBM=Center back mount
 UC=U-Clamp (for panel mount)
 Accuracy: ± 3/2/3% of span



2 1/2" Face x 1/4" Bottom-Steel Case LM		
Part Number	Range psi / kpa	List Price
G25301V	Vacuum 0-30" Hg	\$4.83
G2530301	30 psi x 30" Hg Vacuum	\$4.83
G2530601	60 psi x 30" Hg Vacuum	\$4.83
G25301001	100 psi x 30" Hg Vacuum	\$4.83
G25301601	160 psi x 30" Hg Vacuum	\$4.83
G25151	15 psi / 103 kpa	\$4.83
G25301	30 psi / 200 kpa	\$4.79
G25601	60 psi / 400 kpa	\$4.79
G251001	100 psi / 700 kpa	\$4.79
G251601	160 psi / 1,100 kpa	\$4.79
G252001	200 psi / 1,400 kpa	\$4.79
G253001	300 psi / 2,100 kpa	\$4.79
G254001	400 psi / 2,800 kpa	\$4.79
G256001	600 psi / 4,000 kpa	\$4.79

2 1/2" Face x 1/4" Back-Steel Case UC		
Part Number	Range psi / kpa	List Price
G25302UV	Vacuum 30" Hg	\$5.34
G25152U	15 psi / 103 kpa	\$5.34
G25302U	30 psi / 200 kpa	\$5.26
G25602U	60 psi / 400 kpa	\$5.26
G251002U	100 psi / 700 kpa	\$5.26
G251602U	160 psi / 1,100 kpa	\$5.26
G252002U	200 psi / 1,400 kpa	\$5.26
G253002U	300 psi / 2,100 kpa	\$5.26
G254002U	400 psi / 2,200 kpa	\$5.26
G256002U	600 psi / 4,000 kpa	\$5.26
G2550002U	5,000 psi / 3500 kpa	\$5.26



2 1/2" Face x 1/4" Back-Steel Case CBM		
Part Number	Range psi / kpa	List Price
G25152	15,psi / 103,kpa	\$4.96
G25302	30 psi / 200 kpa	\$4.92
G25602	60 psi / 400 kpa	\$4.92
G251002	100 psi / 700 kpa	\$4.92
G251602	160 psi / 1,100 kpa	\$4.92
G252002	200 psi / 1,400 kpa	\$4.92
G253002	300 psi / 2,100 kpa	\$4.92
G254002	400 psi / 2,200 kpa	\$4.92
G256002	600 psi / 4,000 kpa	\$4.92



SEAL FAST GAUGES

Hydraulic Gauges Liquid Filled



Abbreviations
 LM=Lower mount
 Liquid filling: Glycerine
 Accuracy: $\pm 3/2/3\%$ of span
 Temperature Range: -4°F to 140°F

All Gauges This Page
 Case: Stainless Steel
 Glass: Glass
 Ring: Chrome Plated Steel
 Pointer And Dial: Aluminum
 Internal: Copper Alloy
 Connection: Stainless Steel



2 1/2" Face x 1/4" LM Liquid Filled Stainless Case Brass Internals

Part Number	Range psi / kpa	List Price
G25301PSV	Vacuum 30" Hg	\$11.00
G253030PS	30" Hg Vacuum x 30 psi	\$10.77
G25151PS	15 psi / 103 kpa	\$10.57
G25301PS	30 psi / 200 kpa	\$10.57
G25601PS	60 psi / 400 kpa	\$10.57
G251001PS	100 psi / 700 kpa	\$10.57
G251601PS	160 psi / 1,100 kpa	\$10.57
G252001PS	200 psi / 1,400 kpa	\$10.57
G253001PS	300 psi / 2,100 kpa	\$10.57
G256001PS	600 psi / 4,000 kpa	\$10.57
G2510001PS	1,000 psi / 7,000 kpa	\$10.75
G2515001PS	1,500psi / 10,000 kpa	\$10.75
G2520001PS	2,000 psi / 14,000 kpa	\$10.75
G2530001PS	3,000 psi / 21,000 kpa	\$10.75
G2550001PS	5,000 psi / 35,000 kpa	\$10.75
G25100001PS	10,000 psi / 70,000 kpa	\$10.75

2 1/2" Face x 1/4" LM All Stainless Liquid Filled

Part Number	Range psi / kpa	List Price
G25301PSSV	Vacuum 30"Hg	\$22.60
G253030PSS	30" Hg Vacuum x 30 psi	\$22.60
G25151PSS	15 psi / 103 kpa	\$22.60
G25301PSS	30 psi / 200 kpa	\$22.34
G25601PSS	60 psi / 400 kpa	\$22.34
G251001PSS	100 psi / 700 kpa	\$22.34
G251601PSS	160 psi / 1,100 kpa	\$22.34
G252001PSS	200 psi / 1,400 kpa	\$22.34
G253001PSS	300 psi / 2,100 kpa	\$22.34
G256001PSS	600 psi / 4,000 kpa	\$22.34
G2510001PSS	1,000 psi / 7,000 kpa	\$22.34
G2515001PSS	1,500 psi / 10,000 kpa	\$22.60
G2520001PSS	2,000 psi / 14,000 kpa	\$22.60
G2530001PSS	3,000 psi / 21,000 kpa	\$22.60
G2540001PSS	4,000 psi / 28,000 kpa	\$22.60
G2550001PSS	5,000 psi / 35,000 kpa	\$22.60
G2560001PSS	6,000 psi / 42,000 kpa	\$22.60
G25100001PSS	10,000 psi / 70,000 kpa	\$22.60

E



Accuracy: $\pm 3/2/3\%$ of span



2 1/2" Face x 1/4" UC Liquid Filled Stainless Case - Brass Internals

Part Number	Range psi	List Price
G25302PSUV	Vacuum 30"Hg	\$11.75
G25152PSU	15 psi / 103 kpa	\$11.75
G25302PSU	30 psi / 200 kpa	\$11.75
G25602PSU	60 psi / 400 kpa	\$11.57
G251002PSU	100 psi / 700 kpa	\$11.57
G251602PSU	160 psi / 1,100 kpa	\$11.57
G252002PSU	200 psi / 1,400 kpa	\$11.57
G253002PSU	300 psi / 2,100 kpa	\$11.57
G254002PSU	400 psi / 2,800 kpa	\$11.57
G256002PSU	600 psi / 4,000 kpa	\$11.57
G2510002PSU	1,000 psi / 7,000 kpa	\$11.57
G2520002PSU	2,000 psi / 14,000 kpa	\$11.70
G2530002PSU	3,000 psi / 21,000 kpa	\$11.70
G2550002PSU	5,000 psi / 35,000 kpa	\$11.70
G25100002PSU	10,000 psi / 70,000 kpa	\$11.70

Accuracy: $\pm 3/2/3\%$ of span

2 1/2" Face x 1/4" UCBM All Stainless Liquid Filled

Part Number	Range psi / kpa	List Price
G25302PSSUV	Vacuum 30"Hg	\$23.87
G25152PSSU	15 psi / 103 kpa	\$23.87
G25302PSSU	30 psi / 200 kpa	\$23.87
G25602PSSU	60 psi / 400 kpa	\$23.87
G251002PSSU	100 psi / 700 kpa	\$23.87
G251602PSSU	160 psi / 1,100 kpa	\$23.87
G252002PSSU	200 psi / 1,400 kpa	\$23.87
G253002PSSU	300 psi / 2,100 kpa	\$23.87
G254002PSSU	400 psi / 2,800 kpa	\$23.87
G256002PSSU	600 psi / 4,000 kpa	\$23.87
G2510002PSSU	1,000 psi / 7,000 kpa	\$23.96
G2520002PSSU	2,000 psi / 14,000 kpa	\$23.96
G2530002PSSU	3,000 psi / 21,000 kpa	\$23.96
G2550002PSSU	5,000 psi / 35,000 kpa	\$23.96
G25100002PSSU	10,000 psi / 70,000 kpa	\$23.96



SEAL FAST GAUGES

Hydraulic Gauges Liquid Filled



All Gauges This Page
 Case: Stainless Steel
 Glass: Glass
 Pointer : Aluminum
 Internal: Copper Alloy
 Connection: Stainless Steel
 Temperature Range: -4°F to 140°F



Accuracy: $\pm 3/2/3\%$ of span **DRY**

Abbreviations
 LM=Lower mount
 CBM=Center back mount
 UC=U-Clamp (for panel mount)

Accuracy: $\pm 3/2/3\%$ of span **DRY**

3 1/2" Face x 1/4" LM Steel Case - Brass Internals		
Part Number	Range x psi	List Price
G35301	30 psi / 200 kpa	\$5.85
G35601	60 psi / 400 kpa	\$5.75
G351001	100 psi / 700 kpa	\$5.75
G351601	160 psi / 1,100 kpa	\$5.75
G352001	200 psi / 1,400 kpa	\$5.75
G353001	300 psi / 2,100 kpa	\$5.75
G354001	400 psi / 2,800 kpa	\$5.75
G356001	600 psi / 4,000 kpa	\$5.75

4" Face x 1/4" LM Steel Case - Brass Internals		
Part Number	Range psi / kpa	List Price
G4030301	30" Hg Vacuum X 30 psi	\$11.45
G40151	15 psi / 103 kpa	\$11.45
G40301	30 psi / 200 kpa	\$11.38
G40601	60 psi / 400 kpa	\$11.38
G401001	100 psi / 700 kpa	\$11.38
G401601	160 psi / 1,100 kpa	\$11.38
G402001	200 psi / 1,400 kpa	\$11.38
G403001	300 psi / 2,100 kpa	\$11.38
G404001	400 psi / 2,200 kpa	\$11.38
G406001	600 psi / 4,000 kpa	\$11.38
G4010001	1,000 psi / 7,000 kpa	\$11.38
G4020001	2,000 psi / 14,000 kpa	\$11.38
G4050001	5,000 psi / 35,000 kpa	\$11.38



Accuracy: $\pm 3/2/3\%$ of span

4" Face x 1/4" LM Liquid Filled Stainless Case Brass Internals		
Part Number	Range psi / kpa	List Price
G40151PS	15 psi / 103 kpa	\$23.34
G40301PS	30 psi / 200 kpa	\$22.96
G40601PS	60 psi / 400 kpa	\$22.96
G401001PS	100 psi / 700 kpa	\$22.96
G401601PS	160 psi / 1100 kpa	\$22.96
G402001PS	200 psi / 1400 kpa	\$22.96
G403001PS	300 psi / 2100 kpa	\$22.96
G404001PS	400 psi / 2800 kpa	\$22.96
G406001PS	600 psi / 4000 kpa	\$22.96
G4010001PS	1,000 psi / 7,000 kpa	\$22.96
G4015001PS	1,500 psi / 10,000 kpa	\$22.96
G4020001PS	2,000 psi / 14,000 kpa	\$23.15
G4030001PS	3,000 psi / 21,000 kpa	\$23.15
G4050001PS	5,000 psi / 35,000 kpa	\$23.15
G40100001PS	10,000 psi / 70,000 kpa	\$23.15
G40150001PS	15,000 psi / 10,3421kpa	\$23.15



Accuracy: $\pm 3/2/3\%$ of span

4" Face x 1/2" LM Liquid Filled Stainless Case Brass Internals		
Part Number	Range psi / kpa	List Price
G40151-1PS	15 psi / 103 kpa	\$22.17
G40301-1PS	30 psi / 200 kpa	\$21.70
G40601-1PS	60 psi / 400 kpa	\$21.70
G401001-1PS	100 psi / 700 kpa	\$21.70
G401601-1PS	160 psi / 1100 kpa	\$21.70
G402001-1PS	200 psi / 1400 kpa	\$21.70
G403001-1PS	300 psi / 2100 kpa	\$21.70
G404001-1PS	400 psi / 2800 kpa	\$21.70
G406001-1PS	600 psi / 4000 kpa	\$21.70
G4010001-1PS	1,000 psi / 7,000 kpa	\$22.08
G4020001-1PS	2,000 psi / 14,000 kpa	\$22.08
G4030001-1PS	3,000 psi / 21,000 kpa	\$22.08
G4050001-1PS	5,000 psi / 35,000 kpa	\$22.08
G4060001-1PS	6,000 psi / 70,000 kpa	\$22.08





SEAL FAST GAUGES

Hydraulic Gauges

Case: Stainless Steel
 Glass: Glass
 Pointer : Aluminum
 Internal: Copper Alloy
 Connection: Stainless Steel
 Temperature Range: -4°F to 140°F

Abbreviations
 LM=Lower mount
 Liquid filling: Glycerine
 Accuracy: $\pm 3/2/3\%$ of span
 Temperature Range: -4°F to 140°



E

4" Face x 1/4" LM All Stainless Liquid Filled		
Part Number	Range psi / kpa	List Price
G40151PSS	15 psi / 103 kpa	\$39.06
G40301PSS	30 psi / 200 kpa	\$39.06
G40601PSS	60 psi / 400 kpa	\$39.06
G401001PSS	100 psi / 700 kpa	\$39.06
G401601PSS	160 psi / 1100 kpa	\$39.06
G402001PSS	200 psi / 1400 kpa	\$39.06
G403001PSS	300 psi / 2100 kpa	\$39.06
G404001PSS	400 psi / 2800 kpa	\$39.06
G406001PSS	600 psi / 4000 kpa	\$39.25
G4010001PSS	1,000 psi / 7,000 kpa	\$39.25
G4015001PSS	1,500 psi / 10,000 kpa	\$39.25
G4020001PSS	2,000 psi / 14,000 kpa	\$39.25
G4030001PSS	3,000 psi / 21,000 kpa	\$39.25
G4050001PSS	5,000 psi / 35,000 kpa	\$39.25
G40100001PSS	10,000 psi / 70,000 kpa	\$39.25
G40150001PSS	15,000 psi / 10,3421 kpa	\$39.25

4" Face x 1/2" LM All Stainless Liquid Filled		
Part Number	Range psi / kpa	List Price
G40301-1PSS	30 psi / 200 kpa	\$36.23
G401001-1PSS	100 psi / 700 kpa	\$35.66
G401601-1PSS	160 psi / 1,100 kpa	\$35.66
G402001-1PSS	200 psi / 1,400 kpa	\$35.66
G403001-1PSS	300 psi / 2,100 kpa	\$35.66
G404001-1PSS	400 psi / 2,800 kpa	\$35.66
G406001-1PSS	600 psi / 4,000 kpa	\$35.66
G4010001-1PSS	1,000 psi / 7,000 kpa	\$35.85
G4020001-1PSS	2,000 psi / 14,000 kpa	\$35.85
G4030001-1PSS	3,000 psi / 21,000 kpa	\$35.85
G4050001-1PSS	5,000 psi / 35,000 kpa	\$35.85
G4060001-1PSS	6,000 psi / 42,000 kpa	\$35.85
G40100001-1PSS	10,000 psi / 70,000 kpa	\$35.85

Case: Steel
 Glass: Glass
 Pointer : Aluminum
 Internal: Brass
 Connection: Brass
 Temperature Range: -4°F to 140°F

Ammonia Gauges

Case: Stainless Steel
 Glass: Glass
 Pointer : Aluminum
 Internal: Copper Alloy
 Connection: Stainless Steel
 Temperature Range: -4°F to 140°F



Ammonia Gauge		
2 1/2" Face x 1/4" Steel Case LM		
Part Number	Range x Type	List Price
G2500001A	30"-0-150 psi / 84°F	\$4.53

Ammonia Gauge Liquid Filled		
2 1/2" Face x 1/4" LM Liquid All Stainless		
Part Number	Range x Type	List Price
G250001APSS	30"-0-150 psi / 84°F	\$20.72
G250021APSS	30"-0-400 psi / 84°F	\$20.72



SEAL FAST GAUGES

Front Panel Mount Gauges

Size: 2.5" (63mm)
Accuracy: +-1.6% of Full Scales
Range: 0-15 psi ~ 5000 psi
Working Pressure: Steady - 3/4 of Full Scale
Fluctuating: 2/3 of full scale
Temperature Range: -4°F to 140°F (-20°C to + 60°C)



Housing: Stainless Steel Case & Crimped Ring
Windows: Poly Carbonate
Liquid Filled: Glycerin
Movement: Stainless Steel
Connection: Stainless Steel 1/4" - Socket - Two pieces
Thread: NPT



Part Number	Range psi / kpa	List Price
FFG25152PSSU	15 psi / 103 kpa	\$25.83
FFG25302PSSU	30 psi / 200 kpa	\$25.62
FFG25602PSSU	60 psi / 400 kpa	\$25.62
FFG251002PSSU	100 psi / 700 kpa	\$25.62
FFG251602PSSU	160 psi / 1100 kpa	\$25.62
FFG252002PSSU	200 psi / 1400 kpa	\$25.62
FFG253002PSSU	300 psi / 2100 kpa	\$25.62
FFG254002PSSU	400 psi / 2800 kpa	\$25.62
FFG256002PSSU	600 psi / 4000 kpa	\$25.62
FFG258002PSSU	800 psi / 5500 kpa	\$25.62
FFG2510002PSSU	1000 psi / 7000 kpa	\$25.83
FFG2515002PSSU	1500 psi / 10,000 kpa	\$25.83
FFG2520002PSSU	2000 psi / 14,000 kpa	\$25.83
FFG2530002PSSU	3000 psi / 21,000 kpa	\$25.83
FFG2550002PSSU	5000 psi / 35,000 kpa	\$25.83



Hydraulic Gauges Liquid Filled

Case: Stainless Steel
 Glass: Glass
 Pointer : Aluminum
 Internal: Brass
 Connection: Stainless Steel
 Temperature Range: -4°F to 140°F

Abbreviations
 LM=Lower mount
 Liquid filling: Glycerine
 Accuracy: ± 3/2/3% of span
 Temperature Range: -4°F to 140°F



Accuracy: ± 3/2/3% of span

Accuracy: ± 3/2/3% of span

4" Face x 1/4" UCBM Liquid Filled Stainless Case Brass Internals			4" Face x 1/4" UCBM All Stainless Liquid Filled		
Part Number	Range psi / kpa	List Price	Part Number	Range psi / kpa	List Price
G40152PSU	15 psi / 103 kpa	\$24.51	G40152PSSU	15 psi / 103 kpa	\$37.64
G40302PSU	30 psi / 200 kpa	\$24.15	G40302PSSU	30 psi / 200 kpa	\$37.64
G40602PSU	60 psi / 400 kpa	\$24.15	G40602PSSU	60 psi / 400 kpa	\$37.64
G401002PSU	100 psi / 700 kpa	\$24.15	G401002PSSU	100 psi / 700 kpa	\$37.64
G401602PSU	160 psi / 1100 kpa	\$24.15	G401602PSSU	160 psi / 1,100 kpa	\$37.64
G402002PSU	200 psi / 1400 kpa	\$24.15	G402002PSSU	200 psi / 1,400 kpa	\$37.64
G403002PSU	300 psi / 2100 kpa	\$24.15	G403002PSSU	300 psi / 2,100 kpa	\$37.64
G404002PSU	400 psi / 2800 kpa	\$24.15	G404002PSSU	400 psi / 2,800 kpa	\$37.64
G406002PSU	600 psi / 4000 kpa	\$24.15	G406002PSSU	600 psi / 4,000 kpa	\$37.64
G4010002PSU	1,000 psi / 7,000 kpa	\$24.43	G4010002PSSU	1,000 psi / 7,000 kpa	\$37.64
G4015002PSU	1,500 psi / 10,000 kpa	\$24.43	G4015002PSSU	1,500psi / 10,000 kpa	\$37.64
G4020002PSU	2,000 psi / 14,000 kpa	\$24.43	G4020002PSSU	2,000 psi / 14,000 kpa	\$37.64
G4030002PSU	3,000 psi / 21,000 kpa	\$24.43	G4030002PSSU	3,000 psi / 21,000 kpa	\$37.64
G4050002PSU	5,000 psi / 35,000 kpa	\$24.43	G4050002PSSU	5,000 psi / 35,000 kpa	\$37.64
G40100002PSU	10,000 psi / 70,000 kpa	\$24.43	G40100002PSSU	10,000 psi / 70,000 kpa	\$37.64
G40150002PSU	15,000 psi / 10,3421kpa	\$24.43	G40150002PSSU	15,000 psi / 105,000 kpa	\$37.64



Process Gauges

Standard Features For Process Gauges

Case & Rings: Fiberglass reinforced thermoplastic, black
Window: Acrylic
Dial: White aluminum
Pointer: Aluminum, adjustable
Accuracy: ± 0.5% of full scale ASME B40.1 Grade 2A
Liquid Filling: Glycerin
Tube: 316 Stainless Steel
Tip: 316 Stainless Steel
Temperature Range: -4°F to 140°F

4 1/2" Face x 1/2" LM Process Gauges (Dry)

316 S/S Tube / Alloy Tip & Socket Wika 232.34

Part Number	Range psi	List Price
9834850-200	200	\$75.85
9834065-600	600	\$75.85
9834893-1000	1,000	\$75.85
9834907-1500	1,500	\$75.85
9834915-2000	2,000	\$75.85
9834923-3000	3,000	\$75.85
9834931-5000	5,000	\$75.85
9834940-10000	10,000	\$75.85

4 1/2" Face x 1/2" LM Polycase Process Liquid Filled

316 S/S Tube / Alloy Tip & Socket Wika 233.34

Part Number	Range psi	List Price
L9834031-200	200	\$79.25
L9834885-600	600	\$79.25
L9834074-1000	1,000	\$79.25
L9834907-1500	1,500	\$79.25
L9834915-2000	2,000	\$79.25
L9834923-3000	3,000	\$79.25
L9834931-5000	5,000	\$79.25
L9834940-10000	10,000	\$79.25

Needle Valves / (Small Body Style)

Good for limited space applications.

Designed for applications where caustic liquids and corrosive media are common.

Hard Seat Valves 316 Stainless Steel

10,000 psi 316 Stainless Steel			
Part Number	Size	Style	List Price
SS0011	1/8"	FxF	\$30.96
SS0012	1/4"	FxF	\$30.96
SS0013	3/8"	FxF	\$58.64
SS0014	1/2"	FxF	\$61.92
SS0016	3/4"	FxF	\$178.57
SS0018	1"	FxF	\$203.09
SS0032	1/4"	MxF	\$34.21
SS0034	1/2"	MxF	\$62.49
SS0052	1/4"	FxF Angle	\$37.36
SS0054	1/2"	FxF Angle	\$65.00
SS0072	1/4"	MxF Angle	\$37.36
SS0074	1/2"	MxF Angle	\$65.00
6000 psi 316 Stainless Miniature			
Part Number	Size	Style	List Price
SSM011	1/8"	FxF	\$25.77
SSM012	1/4"	FxF	\$28.36
SSM032	1/4"	MxF	\$25.77

Designed for applications where non corrosive media are used, air, water and oil.

Hard Seat Valves Alloy Steel

10,000 psi Carbon Steel			
Part Number	Size	Style	List Price
CS0011	1/8"	FxF	\$21.92
CS0012	1/4"	FxF	\$21.92
CS0013	3/8"	FxF	\$30.32
CS0014	1/2"	FxF	\$31.60
CS0016	3/4"	FxF	\$89.53
CS0018	1"	FxF	\$96.06
CS0032	1/4"	MxF	\$21.82
CS0034	1/2"	MxF	\$33.51
CS0052	1/4"	FxF Angle	\$24.47
CS0054	1/2"	FxF Angle	\$42.49
CS0072	1/4"	MxF Angle	\$24.47
CS0074	1/2"	MxF Angle	\$42.49
6000 psi Carbon Steel Miniature			
Part Number	Size	Style	List Price
CSM011	1/8"	FxF	\$19.34
CSM012	1/4"	FxF	\$19.34
CSM032	1/4"	MxF	\$19.34





NEEDLE VALVES AND SNUBBERS

Needle Valves / (Large Body Style)

10,000 psi 316 Stainless Steel			
Part Number	Size	Style	List Price
N1312	1/4"	FxF	\$56.62
N1313	3/8"	FxF	\$60.57
N1314	1/2"	FxF	\$64.40
N1316	3/4"	FxF	\$92.77
N1318	1"	FxF	\$144.96
N1332	1/4"	MxF	\$70.87
N1334	1/2"	MxF	\$74.09
N1352	1/4"	FxF Angle	\$70.87
N1354	1/2"	FxF Angle	\$74.09
N1372	1/4"	MxF Angle	\$70.87
N1374	1/2"	MxF Angle	\$74.09

6000 psi 316 Stainless Miniature			
Part Number	Size	Style	List Price
N0311	1/8"	FxF	\$62.45
N0312	1/4"	FxF	\$62.45
N0332	1/4"	MxF	\$62.45

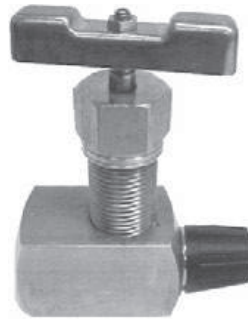

FxM

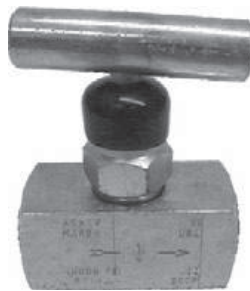

FxF

10,000 psi Carbon Steel			
Part Number	Size	Style	List Price
N1512	1/4"	FxF	\$29.02
N1513	3/8"	FxF	\$35.45
N1514	1/2"	FxF	\$37.36
N1516	3/4"	FxF	\$44.42
N1518	1"	FxF	\$80.47
N1532	1/4"	MxF	\$37.36
N1534	1/2"	MxF	\$37.36
N1552	1/4"	FxF Angle	\$40.57
N1554	1/2"	FxF Angle	\$42.49
N1572	1/4"	MxF Angle	\$40.57
N1574	1/2"	MxF Angle	\$42.49

6000 psi Carbon Steel Miniature			
Part Number	Size	Style	List Price
N0511	1/8"	FxF	\$34.83
N0512	1/4"	FxF	\$34.83
N0532	1/4"	MxF	\$34.83



Pressure Snubbers

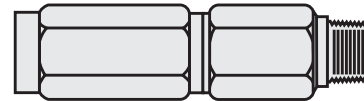

Pressure Surge and Shock Snubbers

Part Number	Body Material	Max psi	Connection Size	List Price
MODEL 010B	Brass	3,000	1/4"	\$60.36
MODEL 050B	Brass	5,000	3/8"	\$107.34
MODEL 060B	Brass	5,000	1/2"	\$96.13
MODEL 010S	303SS	5,000	1/4"	\$123.34
MODEL 060S	303SS	5,000	1/2"	\$169.68

Pigtail Siphons

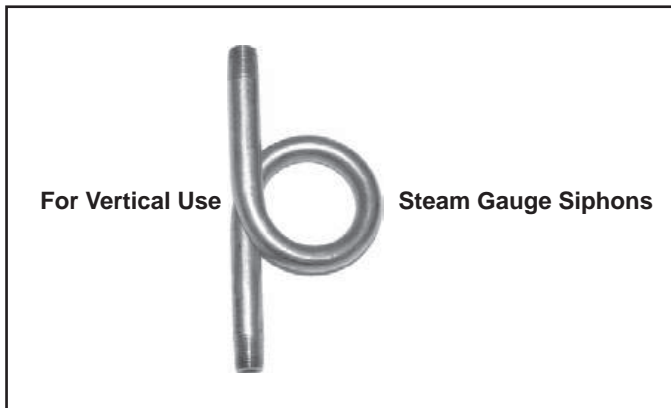

Part Number	Body Material	Size NPT	Pressure Rating	Temp. ° F	List Price
4201779	Brass	1/4"	250	400	\$26.38
4201787	Sch 40 Steel	1/4"	500	400	\$11.79
4201788	Sch 80 Steel	1/4"	800	400	\$11.79
4201761	Sch 40 316SS	1/4"	500	400	\$15.71
4201789	Sch 80 Steel	1/2"	800	400	\$10.83

Coil Siphons

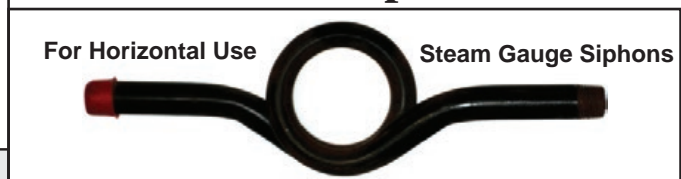

Part Number	Body Material	Size NPT	Pressure Rating	Temp. ° F	List Price
4201809	Brass	1/4"	250	400	\$31.98
4201817	Sch 40 Steel	1/4"	500	400	\$12.59
4201825	Sch 80 Steel	1/4"	800	400	\$12.59
4201833	Sch 80 Steel	1/2"	800	400	\$23.98



HOSE CLAMPS

Seal Fast Clamps



Double Bolt Clamps

USA Sized

(Zinc Plated)

Part Number	Hose O.D New.	List Price
DB0400SF	3-16/32" X 3-26/32"	\$6.04
DB0463SF	4-1/32" X 4-9/32"	\$7.98
DB0525SF	4-8/32" X 4-30/32"	\$9.15
DB0550SF	4-16/32" X 5-8/32"	\$9.43
DB0600SF	5-4/32" X 5-22/32"	\$9.79
DB0675SF	5-3/32" X 6-16/32"	\$11.89
DB0769SF	6-16/32" X 7-18/32"	\$16.06
DB0818SF	7-22/32" X 8-6/32"	\$21.83
DB0875SF	8-8/32" X 8-28/32"	\$20.57
DB0988SF	8-30/32" X 9-28/32"	\$31.98
DB1125SF	9-30/32" X 11-12/32"	\$39.62
DB1275SF	1-6/32" X 13"	\$63.11
DB1450SF	13-6/32" X 15"	\$75.77

Double Bolt Clamps (Zinc Plated)

Please check Hose O.D. before ordering.

Part Number *	Hose O.D New.	List Price	Part Number	Hose O.D New	List Price
0022 DB	21/32" To 7/8"	\$1.19	0550 DBU	4-1/8" To 4-5/8"	\$9.34
0029 DB	7/8" To 1-9/64"	\$1.70	0600 DBU	4-7/8" To 5-1/4"	\$10.36
0034 DB	1-5/16" To 1-1/32	\$1.74	0675 DBU	5-5/8" To 6-5/8"	\$11.11
0040 DB	1-15/32" To 1-25/32"	\$2.57	0769 DBU	6-1/2" To 6-3/4"	\$14.51
0049 DB	1-3/4" To 1-15/16"	\$3.09	0818 DBU	6-1/2" To 7-3/4"	\$21.98
0060 DB	1-7/8" To 2-3/8"	\$3.68	0875 DBU	7-5/8" To 8-1/4"	\$23.49
0076 DB	2-3/8" To 2-7/8"	\$4.25	0988 DBU	8-3/8" To 9-1/8"	\$25.94
0094 DB	3-1/2" To 3-11/16"	\$6.51	--	--	--
0400 DBU	2-3/4" To 3-1/2"	\$6.06	--	--	--
0463 DBU	3-1/2" To 4-1/8"	\$6.23	--	--	--
0525 DBU	4-1/4" To 4-5/8"	\$9.34	--	--	--

* U - Undersized

F

Spiral Hose Clamps (Zinc Plated)

Spiral Bolt Clamps

Size	Part Number Left Hand	Part Number Right Hand	List Price
2"	200 SCL	200 SCR	\$1.85
2-1/2"	250 SCL	250 SCR	\$2.38
3"	300 SCL	300 SCR	\$2.74
4"	400 SCL	400 SCR	\$5.09
5"	500 SCL	500 SCR	\$5.70
6"	600 SCL	600 SCR	\$6.89
8"	800 SCL	800 SCR	\$9.62
10"	1000 SCL	1000 SCR	\$13.00
12"	1200 SCL	1200 SCR	\$16.02



Left Hand
Spiral



Right Hand
Spiral

Recommended for PVC suction or discharge.

Clamps for Universal Hose Couplings and Ground Joints

Please check Hose O.D. before ordering.		Cast Iron Zinc Plated							
Hose I.D.	For Hose O.D.		Part Number	List Price	Hose I.D.	For Hose O.D.		Part Number	List Price
	From	To				From	To		
3/8"	11/16"	7/8"	SF1	\$2.34	1-1/4"	1-25/32"	2-3/32"	SF19U	\$13.68
1/2"	13/16"	15/16"	SF2	\$2.74	1-1/2"	2-3/16"	2-3/8"	SF24U	\$12.74
1/2"	15/16"	1-1/16"	SF4	\$2.62	1-1/2"	2-1/4"	2-9/16"	SF24	\$15.94
1/2"	1-1/16"	1-3/16"	SF5	\$2.74	1-1/2"	2-9/16"	2-3/4"	SF25	\$15.89
3/4"	1-1/8"	1-5/16"	SF9A	\$2.89	2"	2-8/16"	2-25/32"	SF29U	\$17.64
3/4"	1-3/16"	1-5/16"	SF9U	\$3.64	2"	2-3/4"	3-1/16"	SF29	\$17.92
3/4"	1-5/16"	1-1/2"	SF9B	\$4.25	2"	3-3/32"	3-7/16"	SF30	\$20.28
3/4"	1-1/2"	1-11/16"	SF10	\$5.58	4"	4-1/16"	4-7/16"	SF39	\$45.94
1"	1-17/32"	1-23/32"	SF14U	\$7.57	4"	4-7/8"	5-5/16"	SF49U	\$108.77
1"	1-11/16"	1-15/16"	SF14	\$8.68	4"	5-1/8"	6-3/16"	SF49	\$113.96



3/8" to 3/4" ID



1" to 2" ID



4" ID



Seal Fast Clamps One Bolt Hose Clamps

	Part Number	Opening Size	Band Width & Thickness	mm Size	Clamps Per Pkg.	List Price Per Clamp
 <p>Finish: Carbon Steel Zinc Plated</p>	901	1 1/16" X 3/4"	0.70" X 0.024"	17 - 19	50	\$0.77
	902	25/32" X 7/8"	0.70" X 0.024"	20 - 22	50	\$0.77
	904	29/32" X 1"	0.70" X 0.024"	23 - 25	50	\$0.77
	905	1 1/64" X 1 7/64"	0.70" X 0.024"	26 - 28	50	\$0.77
	907	1 5/32" X 1 7/32"	0.79" X 0.039"	29 - 31	50	\$0.89
	908	1 1/4" X 1 3/8"	0.79" X 0.039"	32 - 35	50	\$0.91
	909	1 27/64" X 1 1/2"	0.79" X 0.039"	36 - 38	50	\$0.92
	911	1 9/16" X 1 11/16"	0.79" X 0.039"	40 - 43	50	\$0.92
	912	1 23/32" X 1 27/32"	0.79" X 0.039"	44 - 47	50	\$1.06
	913	1 7/8" X 2"	0.79" X 0.039"	48 - 51	50	\$1.13
	914	2 1/16" X 2 5/32"	0.79" X 0.039"	52 - 55	50	\$1.15
	915	2 3/16" X 2 5/16"	0.79" X 0.039"	56 - 59	50	\$1.17
	916	2 11/32" X 2 15/32"	0.79" X 0.039"	60 - 63	50	\$1.19
	917	2 1/2" X 2 5/8"	0.79" X 0.031"	64 - 67	25	\$1.36
	918	2 11/16" X 2 7/8"	0.79" X 0.031"	68 - 73	25	\$1.74
	919	2 29/32" X 3 3/32"	0.98" X 0.047"	74 - 79	25	\$1.89
	920	3 1/8" X 3 5/16"	0.98" X 0.047"	80 - 85	25	\$1.91
	921	3 5/16" X 3 9/16"	0.98" X 0.047"	86 - 91	25	\$1.98
	922	3 5/8" X 3 13/16"	0.98" X 0.047"	92 - 97	25	\$2.02
	923	3 7/8" X 4 1/16"	0.98" X 0.047"	98 - 103	25	\$2.06
	924	4 3/32" X 4 3/8"	0.98" X 0.047"	104 - 112	25	\$2.13
	925	4 3/8" X 4 3/4"	0.98" X 0.047"	113 - 121	25	\$2.15
	926	4 3/4" X 5 1/8"	0.98" X 0.047"	122 - 130	25	\$2.19
	927	5 1/8" X 5 1/2"	0.98" X 0.047"	131 - 139	25	\$3.15
	928	5 1/2" X 5 7/8"	0.98" X 0.047"	140 - 148	25	\$3.19
	929	5 7/8" X 6 3/8"	0.98" X 0.047"	149 - 161	25	\$3.34
	930	6 3/8" X 6 7/8"	0.98" X 0.047"	162 - 174	10	\$3.57
	931	6 7/8" X 7 3/8"	0.98" X 0.047"	175 - 187	10	\$3.66
932	7 3/8" X 7 7/8"	0.98" X 0.047"	188 - 200	10	\$3.87	
933	7 7/8" X 8 3/8"	0.98" X 0.047"	201 - 213	10	\$3.92	
934	8 3/8" X 8 7/8"	0.98" X 0.047"	214 - 226	10	\$4.02	
935	8 7/8" X 9 3/8"	1.09" X 0.062"	227 - 239	10	\$4.15	
936	9 3/8" X 9 7/8"	1.09" X 0.062"	240 - 252	10	\$4.23	

F

Wide band Hose Clamps

WIDE BAND	Part Number	Opening Size	Band Width & Thickness	mm Size	Clamps Per Pkg.	List Price Per Clamp
 <p>Finish: Carbon Steel Zinc Plated</p>	W781	1 23/32" X 1 7/8"	0.79" X 0.039"	44 - 49	50	\$8.49
	W782	1 15/16" X 2 5/32"	0.79" X 0.039"	50 - 55	50	\$8.79
	W783	2 3/16" X 2 3/8"	0.79" X 0.039"	56 - 61	50	\$9.30
	W784	2 7/16" X 2 5/8"	0.79" X 0.039"	62 - 67	50	\$9.53
	W785	2 11/16" X 2 7/8"	0.79" X 0.039"	68 - 73	50	\$10.04
	W786	2 29/32" X 3 3/32"	0.79" X 0.039"	74 - 79	50	\$10.60
	W787	3 1/8" X 3 5/16"	0.79" X 0.039"	80 - 85	50	\$10.70
	W788	3 5/16" X 3 9/16"	0.79" X 0.039"	86 - 91	25	\$11.32
	W789	3 5/8" X 3 13/16"	0.79" X 0.039"	92 - 97	25	\$11.89
	W7810	3 7/8" X 4 1/16"	0.79" X 0.039"	98 - 103	25	\$12.49
	W7811	4 3/32" X 4 3/8"	0.79" X 0.039"	104 - 119	25	\$13.23
	W7812	4 5/16" X 4 9/16"	0.98" X 0.047"	110 - 115	25	\$13.40



Seal Fast Clamps

STAINLESS CLAMP	Part Number	Opening Size	Band Width & Thickness	mm Size	Clamps Per Pkg.	List Price Per Clamp
	 <p>All Stainless Steel</p>	307	1 5/32" x 1 7/32"	0.79" X 0.039"	29-31	50
308		1 1/4" x 1 3/8"	0.79" X 0.039"	32-35	50	\$1.94
309		1 13/32" x 1 1/2"	0.79" X 0.039"	36-39	50	\$1.98
310		1 9/16" x 1 11/16"	0.79" X 0.039"	40-43	50	\$2.00
311		1 23/32" x 1 27/32"	0.79" X 0.039"	44-47	50	\$2.28
312		1 7/8" x 2"	0.79" X 0.039"	48-51	25	\$2.32
313		2 1/16" x 2 5/32"	0.79" X 0.039"	52-55	25	\$2.38
314		2 7/32" x 2 5/16"	0.79" X 0.039"	56-59	25	\$2.40
315		2 11/32" x 2 15/32"	0.79" X 0.039"	60-63	25	\$2.45
316		2 1/2" x 2 5/8"	0.79" X 0.039"	64-67	25	\$2.47
317		2 11/16" x 2 7/8"	0.79" X 0.039"	68-73	25	\$3.11
318		2 29/32" x 3 3/32"	0.98" X 0.047"	74-79	25	\$3.26
319		3 1/8" x 3 5/16"	0.98" X 0.047"	80-85	25	\$3.32
320		3 3/8" x 3 9/16"	0.98" X 0.047"	86-91	25	\$3.40
321		3 5/8" x 3 13/16"	0.98" X 0.047"	92-97	25	\$3.43
322		3 7/8" x 4 1/16"	0.98" X 0.047"	98-103	25	\$3.49
323		4 3/32" x 4 3/8"	0.98" X 0.047"	104-112	25	\$3.57
324		4 3/8" x 4 3/4"	0.98" X 0.047"	113-121	25	\$3.64
325		4 3/4" x 5 1/8"	0.98" X 0.047"	122-130	25	\$3.72
326		5 1/8" x 5 1/2"	0.98" X 0.047"	131-139	25	\$5.79
327	5 1/2" x 5 7/8"	0.98" X 0.062"	140-148	25	\$6.04	
328	5 7/8" x 6 3/8"	0.98" X 0.062"	149-161	25	\$6.04	
329	6 3/8" x 6 7/8"	0.98" X 0.062"	162-174	25	\$6.36	
330	6 7/8" x 7 3/8"	0.98" X 0.062"	175-187	25	\$6.51	
331	7 3/8" x 7 7/8"	0.98" X 0.062"	188-200	25	\$6.66	
332	7 7/8" x 8 3/8"	0.98" X 0.062"	201-213	25	\$6.77	
333	8 3/8" x 8 7/8"	0.98" X 0.062"	214-226	25	\$6.94	
334	8 7/8" x 9 3/8"	1.09" X 0.062"	227-239	25	\$7.06	
335	9 3/8" x 9 7/8"	1.09" X 0.062"	240-252	25	\$7.17	



Heavy Duty 2-Bolt

Heavy Duty 2-Bolt	Part Number	Opening Size	Band Width & Thickness	mm Size	Clamps Per Pkg.	List Price Per Clamp
	 <p>Zinc Plated</p>	SD50	1 5/8" x 2"	0.70" X 0.024"	41-51	50
SD55		1 13/16" x 2 1/4"	0.70" X 0.024"	46-56	50	\$2.30
SD60		2" x 2 7/16"	0.70" X 0.024"	51-61	50	\$2.36
SD65		2 1/4" x 2 9/16"	0.70" X 0.024"	56-66	50	\$2.43
SD70		2 7/16" x 2 13/16"	0.70" X 0.024"	61-71	50	\$2.49
D75		2 9/16" x 3"	0.70" X 0.024"	66-76	50	\$2.57
D80		2 13/16" x 3 3/16"	0.70" X 0.024"	71-81	50	\$2.60
D85		3 "x 3 5/16"	0.79" X 0.039"	76-86	50	\$2.68
D90		3 3/16" x 3 9/16"	0.79" X 0.039"	81-91	50	\$3.00
D95		3 5/16" x 3 11/16"	0.79" X 0.039"	86-96	50	\$3.11
D100		3 9/16" x 3 15/16"	0.79" X 0.039"	91-101	50	\$4.00
D105		3 11/16" x 4 1/4"	0.79" X 0.039"	96-106	50	\$4.00
D110		3 15/16" x 4 3/8"	0.79" X 0.039"	101-111	50	\$4.08
D115		4 1/4" x 4 9/16"	0.79" X 0.031"	106-116	25	\$4.15
D120		4 3/8" x 4 3/4"	0.79" X 0.031"	111-121	25	\$4.21
D125		4 9/16" x 4 15/16"	0.79" X 0.031"	116-126	25	\$4.26
D130		4 3/4" x 5 3/16"	0.79" X 0.031"	121-131	25	\$4.30
D140		5 3/16" x 5 1/2"	0.79" X 0.031"	131-141	25	\$4.43
D150		5 1/2" x 5 13/16"	0.98" X 0.047"	141-151	25	\$4.64
D160		5 13/16" x 6 3/8"	0.98" X 0.047"	151-161	25	\$4.74
D170	6 3/8" x 6 11/16"	0.98" X 0.047"	161-171	25	\$4.83	
D180	6 11/16" x 7 1/8"	0.98" X 0.047"	171-181	25	\$4.92	
D190	7 1/8" x 7 9/16"	0.98" X 0.047"	181-191	25	\$5.02	
D200	7 9/16" x 7 7/8"	0.98" X 0.047"	191-201	25	\$5.13	
D210	7 7/8" x 7 5/16"	0.98" X 0.047"	201-211	25	\$5.25	
D220	7 15/16" x 8 7/8"	0.98" X 0.047"	211-221	25	\$5.34	
D230	8 7/8" x 9 1/8"	1.09" X 0.062"	221-231	10	\$5.42	

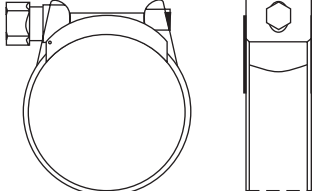

MIKALOR HOSE CLAMPS

Mikalor Bolt Hose Clamps

	Part Number	Opening Size	Band Width & Thickness	mm Size	Torque * Max. ft. lbs.	Clamps Per Box	List Price Per Clamp
 <p>Bolt: Zinc Plated Band & Arch: Stainless AISI-430 Other Components: Zinc Plated steel</p> <p>We recommend working at 75% of the maximum values.</p> 	301901-2	11/16" X 3/4"	0.70" X 0.024"	17-19	3.3	50	\$3.42
	301902-0	3/4" X 13/16"	0.70" X 0.024"	19-20	3.3	50	\$3.47
	301903-9	13/16" X 29/32"	0.70" X 0.024"	21-23	3.3	50	\$3.48
	301904-7	29/32" X 1"	0.70" X 0.024"	23-25	3.3	50	\$3.54
	301905-5	1" X 1-1/16"	0.70" X 0.024"	25-27	3.3	50	\$3.58
	301906-3	1-1/16" x 1-5/32"	0.70" X 0.024"	27-29	3.3	50	\$3.63
	301907-1	1-5/32" x 1-7/32"	0.70" X 0.024"	29-31	3.3	50	\$4.28
	301908-0	1-7/32" X 1-5/16"	0.79" X 0.039"	31-34	5.9	50	\$4.41
	301909-8	1-5/16" X 1-7/16"	0.79" X 0.039"	34-37	5.9	50	\$4.67
	301910-0	1-7/16" X 1-9/16"	0.79" X 0.039"	37-40	5.9	50	\$4.70
	301911-9	1-9/16" X 1-11/16"	0.79" X 0.039"	40-43	5.9	50	\$4.77
	301912-7	1-11/16" X 1-27/32"	0.79" X 0.039"	43-47	5.9	50	\$5.45
	301913-5	1-27/32" X 2"	0.79" X 0.039"	47-51	7.4	50	\$5.67
	301914-3	2" X 2-5/32"	0.79" X 0.031"	51-55	7.4	25	\$5.77
	301915-1	2-5/32" X 2-5/16"	0.79" X 0.031"	55-59	7.4	25	\$6.05
	301916-0	2-5/16" X 2-15/32"	0.79" X 0.031"	59-63	7.4	25	\$6.27
	301917-8	2-15/32" X 2-11/16"	0.79" X 0.031"	63-68	7.4	25	\$6.59
	301918-6	2-11/16" X 2-7/8"	0.79" X 0.031"	68-73	7.4	25	\$8.42
	301919-4	2-7/8" X 3-3/32"	0.98" X 0.047"	73-79	18.4	25	\$8.63
	301920-7	3-3/32" X 3-5/16"	0.98" X 0.047"	79-85	18.4	25	\$8.85
	301921-5	3-5/16" X 3-9/16"	0.98" X 0.047"	85-91	18.4	25	\$9.07
	301922-3	3-9/16" X 3-13/16"	0.98" X 0.047"	91-97	18.4	25	\$9.28
	301923-1	3-13/16" X 4-3/32"	0.98" X 0.047"	91-104	18.4	25	\$9.58
	301924-0	4-3/32" X 4-3/8"	0.98" X 0.047"	104-112	18.4	25	\$10.13
	301925-8	4-3/8" X 4-3/4"	0.98" X 0.047"	112-121	18.4	25	\$10.38
	301926-6	4-3/4" X 5-1/8"	0.98" X 0.047"	121-130	18.4	25	\$10.66
	301927-4	5-1/8" X 5-1/2"	1.09" X 0.062"	131-139	36.8	10	\$15.11
	301928-2	5-1/2" X 5-7/8"	1.09" X 0.062"	140-148	36.8	10	\$15.44
	301929-0	5-7/8" X 6-3/8"	1.09" X 0.062"	149-161	36.8	10	\$15.83
	301930-3	6-3/8" X 6-7/8"	1.09" X 0.062"	162-174	36.8	10	\$16.19
	301931-1	6-7/8" X 7-3/8"	1.09" X 0.062"	175-187	36.8	10	\$16.63
	301932-0	7-3/8" X 7-7/8"	1.09" X 0.062"	188-200	36.8	10	\$17.04
	301933-8	7-7/8" X 8-3/8"	1.09" X 0.062"	201-213	36.8	10	\$17.43
	301934-6	8-3/8" X 8-7/8"	1.09" X 0.062"	214-226	36.8	10	\$17.85
	301935-4	8-7/8" X 9-3/8"	1.09" X 0.062"	227-239	36.8	10	\$18.68
	301936-2	9-3/8" X 9-7/8"	1.09" X 0.062"	240-252	36.8	10	\$41.11



	Part Number	Opening Size	Band Width & Thickness	mm Size	Torque * Max. ft. lbs.	Clamps Per Pkg.	List Price Per Clamp
 <p>All Stainless Steel AISI-304</p> <p>We recommend working at 75% of the maximum values.</p>	301307-1	1-5/32" X 1-7/32"	0.79" X 0.039"	29-31	11.0	50	\$11.19
	301308-3	1-7/32" X 1-5/16"	0.79" X 0.039"	31-34	11.0	50	\$11.31
	301309-1	1-5/16" X 1-7/16"	0.79" X 0.039"	34-37	11.0	50	\$11.62
	301310-4	1-7/16" X 1-9/16"	0.79" X 0.039"	37-40	11.0	50	\$11.76
	301311-2	1-9/16" X 1-11/16"	0.79" X 0.039"	40-43	11.0	50	\$11.92
	301312-0	1-11/16" X 1-27/32"	0.79" X 0.039"	43-47	11.0	50	\$12.79
	301313-9	1-27/32" X 2"	0.79" X 0.039"	47-51	11.0	50	\$12.90
	301314-7	2" X 2-5/32"	0.79" X 0.039"	51-55	11.0	25	\$13.18
	301315-5	2-5/32" X 2-5/16"	0.79" X 0.039"	55-59	11.0	25	\$13.42
	301316-3	2-5/16" X 2-15/32"	0.79" X 0.039"	59-63	11.0	25	\$13.48
	301317-1	2-15/32" X 2-11/16"	0.79" X 0.039"	63-68	11.0	25	\$13.97
	301318-0	2-11/16" X 2-7/8"	0.98" X 0.047"	68-73	18.4	25	\$18.99
	301319-8	2-7/8" X 3-3/32"	0.98" X 0.047"	73-79	18.4	25	\$19.63
	301320-0	3-3/32" X 3-5/16"	0.98" X 0.047"	79-85	18.4	25	\$20.02
	301321-9	3-5/16" X 3-9/16"	0.98" X 0.047"	85-91	18.4	25	\$20.42
	301322-7	3-9/16" X 3-13/16"	0.98" X 0.047"	91-97	18.4	25	\$20.90
	301323-5	3-13/16" X 4-3/32"	0.98" X 0.047"	97-104	18.4	25	\$21.35
	301324-3	4-3/32" X 4-3/8"	0.98" X 0.047"	104-112	18.4	25	\$21.86
	301325-1	4-3/8" X 4-3/4"	0.98" X 0.047"	112-121	18.4	25	\$22.28
	301326-0	4-3/4" X 5-1/8"	0.98" X 0.047"	121-130	18.4	25	\$22.65



SEAL FAST HOSE CLAMPS



Seal Fast Preformed Stainless Clamps

F

Type 302 Stainless Steel 3/8" , 5/8" and 3/4" (Nominal) Width								
Clamp Diameter	Part Number 3/8 & 5/8 Wide	Clamps Per Box	Band Width & Thickness	List Price/ 100 Clamps	Part Number 3/4 Wide	Clamps Per Box	Band Width & Thickness	List Price/ 100 Clamps
13/16"	SF03KS	100	3/8" x 0.020"	\$56.60	--	--	--	--
1-3/8"	SF311KS	100	3/8" x 0.020"	\$64.15	--	--	--	--
1"	SF04KS	100	5/8" x 0.022"	\$84.91	--	--	--	--
1-1/4"	SF05KS	100	5/8" x 0.022"	\$92.45	--	--	--	--
1-1/2"	SF06KS	100	5/8" x 0.022"	\$100.00	--	--	--	--
1-3/4"	SF07KS	100	5/8" x 0.022"	\$107.55	--	--	--	--
2"	SF08KS	100	5/8" x 0.022"	\$115.09	SF0875KS	100	3/4" X 0.030"	\$130.19
2-1/4"	SF09KS	100	5/8" x 0.022"	\$124.53	SF0975KS	100	3/4" X 0.030"	\$139.62
2-1/2"	SF10KS	60	5/8" x 0.022"	\$132.08	SF1075KS	60	3/4" X 0.030"	\$139.62
2-3/4"	SF11KS	50	5/8" x 0.022"	\$135.85	SF1175KS	50	3/4" X 0.030"	\$139.62
3"	SF12KS	25	5/8" x 0.022"	\$145.28	SF1275KS	25	3/4" X 0.030"	\$149.06
3-1/2"	SF14KS	25	5/8" x 0.022"	\$156.60	SF1475KS	25	3/4" X 0.030"	\$167.92
4"	SF16KS	25	5/8" x 0.022"	\$171.70	SF1675KS	25	3/4" X 0.030"	\$184.91
4-1/2"	SF18KS	25	5/8" x 0.022"	\$186.79	SF1875KS	25	3/4" X 0.030"	\$201.89
5"	SF20KS	25	5/8" x 0.022"	\$190.57	SF2075KS	25	3/4" X 0.030"	\$218.87
6"	SF24KS	25	5/8" x 0.022"	\$205.66	SF2475KS	25	3/4" X 0.030"	\$241.51
7"	SF28KS	15	5/8" x 0.022"	\$245.28	SF2875KS	15	3/4" X 0.030"	\$264.15
8"	SF32KS	20	5/8" x 0.022"	\$273.58	SF3275KS	20	3/4" X 0.030"	\$296.23

Type 302 Stainless Steel J Series With Smooth I.D. 5/8" and 3/4" (Nominal) Width

201 Stainless Steel Strap and Buckles

Clamp Diameter	Part Number 5/8 & 3/4 Wide	Clamps Per Box	Band Width & Thickness	List Price/ 100 Clamps	Strapping	Feet Per Box	Band Width & Thickness	List Price Per Box
1"	SF203JS	100	5/8" x 0.030"	\$128.30	SF5000SS	100'	1/2" x .030"	\$55.66
1-1/4"	SF204JS	100	5/8" x 0.030"	\$139.62	SF5800SS	100'	5/8" x .030"	\$73.58
1-1/2"	SF205JS	100	5/8" x 0.030"	\$156.60	SF7500SS	100'	3/4" x .030"	\$84.91
1-3/4"	SF206JS	100	5/8" x 0.030"	\$167.92	SF3800SS	100'	3/8" x .030"	\$28.30
2"	SF207JS	100	5/8" x 0.030"	\$181.13				
2-1/4"	SF208JS	100	5/8" x 0.030"	\$194.34				
2-1/2"	SF209JS	100	5/8" x 0.030"	\$205.66				
2"	SF227JS	100	3/4" x 0.030"	\$220.75	Buckles	Per Box		List Price
2-3/4"	SF210JS	50	3/4" x 0.030"	\$260.38	SF5000BS	100		\$0.2830
3"	SF211JS	50	3/4" x 0.030"	\$271.70	SF5800BS	100		\$0.3585
3-1/2"	SF212JS	50	3/4" x 0.030"	\$298.11	SF7500BS	50		\$0.6792
4"	SF213JS	50	3/4" x 0.030"	\$322.64	SF3800BS	50		\$0.1887
4-1/2"	SF214JS	25	3/4" x 0.030"	\$358.49				
5"	SF215JS	25	3/4" x 0.030"	\$383.02				
6"	SF216JS	25	3/4" x 0.030"	\$433.96				
6-1/2"	SF217JS	25	3/4" x 0.030"	\$464.15				
7"	SF218JS	25	3/4" x 0.030"	\$484.91				
8"	SF219JS	25	3/4" x 0.030"	\$533.96				

Seal Fast Tool



SEAL FAST Center Punch Tool for 5/8" Clamps

Part Number

List Price

CPT 100

\$117.92



SEAL FAST HOSE CLAMPS



F

Seal Fast General Purpose Industrial Clamps

Part Number	Screw Type	Inch Diameter	Metric MM Diameter	List Price/100
Carbon Steel Miniatures 3-Piece Construction 5/16" Band				
WDMC04	●	7/32" X 5/8"	5.5 X 16	\$15.10
WDMC06	●	7/16" X 25/32"	11 X 20	\$15.99
WDMC08	●	1/2" X 29/32"	13 X 23	\$15.99
WDMC10	●	9/16" X 1-1/16"	14 X 27	\$17.44
Carbon Steel Full Size 3-Piece Construction 1/2" Band				
WDC006	●	7/16" X 25/32"	11 X 20	\$32.03
WDC008	●	1/2" X 29/32"	13 X 23	\$32.92
WDC010	●	9/16" X 1-1/16"	14 X 27	\$33.30
WDC012	●	11/16" X 1-1/4"	18 X 32	\$34.20
WDC016	●	13/16" X 1-1/2"	21 X 38	\$35.95
WDC020	●	13/16" X 1-3/4"	21 X 44	\$36.84
WDC024	●	1-1/16" X 2"	27 X 51	\$37.70
WDC028	●	1-5/16" X 2-1/4"	33 X 57	\$39.45
WDC032	●	1-9/16" X 2-1/2"	40 X 63	\$41.19
WDC036	●	1-13/16" X 2-3/4"	46 X 70	\$42.13
WDC040	●	2-1/16" X 3"	52 X 76	\$44.56
Carbon Steel 1/2" Band				
WDC044	●	2-5/16" X 3-1/4"	59 X 82	\$45.50
WDC048	●	2-9/16" X 3-1/2"	65 X 89	\$48.96
WDC052	●	2-13/16" X 3-1/2"	72 X 95	\$49.89
WDC056	●	3-1/16" X 4"	78 X 101	\$51.56
WDC060	●	3-5/16" X 4-1/4"	84 X 108	\$53.48
WDC064	●	3-9/16" X 4-1/2"	91 X 114	\$56.67
WDC072	●	4-1/8" X 5"	105 X 127	\$59.36
WDC080	●	4-5/8" X 5-1/2"	117 X 139	\$62.86
WDC088	●	5-1/8" X 6"	130 X 152	\$67.25
WDC096	●	5-5/8" X 6-1/2"	143 X 165	\$74.03
WDC104	●	6-1/8" X 7"	156 X 178	\$75.69

Band, Housing, and Screw Carbon Steel Zinc plated

Seal Fast General Purpose Industrial Clamps

Part Number	Screw Type	Inch Diameter	Metric MM Diameter	List Price/100
Miniatures 200% Stainless Steel 3-Piece Construction 5/16" Band				
WDS004	○	7/32" X 5/8"	5.5 X 16	\$32.71
WDS006	○	7/16" X 25/32"	11 X 20	\$34.24
WDS008	○	1/2" X 29/32"	13 X 23	\$34.24
WDS010	○	9/16" X 1-1/16"	14 X 27	\$34.67
Full Size Stainless Steel 3-Piece Construction 1/2" Band				
WDS006	○	7/16" X 25/32"	11 X 20	\$66.40
WDS008	○	1/2" X 29/32"	13 X 23	\$67.80
WDS010	○	9/16" X 1-1/16"	14 X 27	\$69.98
WDS012	○	11/16" X 1-1/4"	18 X 32	\$72.84
WDS016	○	13/16" X 1-1/2"	21 X 38	\$74.97
WDS020	○	13/16" X 1-3/4"	21 X 44	\$78.55
WDS024	○	1-1/16" X 2"	27 X 51	\$81.41
WDS028	○	1-5/16" X 2-1/4"	33 X 57	\$84.95
WDS032	○	1-9/16" X 2-1/2"	40 X 63	\$88.66
WDS036	○	1-13/16" X 2-3/4"	46 X 70	\$91.47
WDS040	○	2-1/16" X 3"	52 X 76	\$92.24
Stainless Steel 1/2" Band				
WDS044	○	2-5/16" X 3-1/4"	59 X 82	\$95.74
WDS048	○	2-9/16" X 3-1/2"	65 X 89	\$99.15
WDS052	○	2-13/16" X 3-1/2"	72 X 95	\$101.54
WDS056	○	3-1/16" X 4"	78 X 101	\$105.50
WDS060	○	3-5/16" X 4-1/4"	84 X 108	\$108.78
WDS064	○	3-9/16" X 4-1/2"	91 X 114	\$114.97
WDS072	○	4-1/8" X 5"	105 X 127	\$120.51
WDS080	○	4-5/8" X 5-1/2"	117 X 139	\$125.37
WDS088	○	5-1/8" X 6"	130 X 152	\$132.28
WDS096	○	5-5/8" X 6-1/2"	143 X 165	\$142.17
WDS104	○	6-1/8" X 7"	156 X 178	\$145.54

Band, Housing and Screw 304 SS



SEAL FAST HOSE CLAMPS



Seal Fast

9/16" Band All Stainless



Seal Fast Clamp Kit

F

Part Number	Screw Type	Inch Diameter	Metric MM Diameter	List Price Per 100
100% Stainless Steel 3-Piece Construction 9/16" Band				
WDS2010	⊖	9/16" X 1-1/16"	14 X 27	\$88.53
WDS2012	⊖	11/16" X 1-1/4"	18 X 32	\$91.86
WDS2016	⊖	13/16" X 1-1/2"	21 X 38	\$95.44
WDS2020	⊖	13/16" X 1-3/4"	21 X 44	\$98.46
WDS2024	⊖	1-1/16" X 2"	27 X 51	\$101.88
WDS2028	⊖	1-5/16" X 2-1/4"	33 X 57	\$107.33
WDS2032	⊖	1-9/16" X 2-1/2"	40 X 63	\$109.77
WDS2036	⊖	1-13/16" X 2-3/4"	46 X 70	\$115.31
WDS2040	⊖	2-1/16" X 3"	52 X 76	\$120.09
WDS2044	⊖	2-5/16" X 3-1/4"	59 X 82	\$123.24
WDS2048	⊖	2-9/16" X 3-1/2"	65 X 89	\$128.87
WDS2052	⊖	2-13/16" X 3-3/4"	72 X 95	\$134.46
WDS2056	⊖	3-1/16" X 4"	78 X 102	\$141.58
WDS2060	⊖	3-5/16" X 4-1/4"	84 X 108	\$147.16
WDS2064	⊖	3-9/16" X 4-1/2"	90 X 114	\$151.13
WDS2072	⊖	1-7/8" X 5"	47 X 127	\$159.10
WDS2080	⊖	2-1/2" X 5-1/2"	63 X 140	\$168.61
WDS2088	⊖	3-1/8" X 6"	79 X 152	\$179.70
WDS2096	⊖	3-5/8" X 6-1/2"	92 X 165	\$194.88
WDS2104	⊖	4-1/8" X 7"	104 X 177	\$199.62
WDS2128	⊖	5-5/8" X 8-1/2"	142 X 215	\$242.99
WDS2152	⊖	7-1/8" X 10"	180 X 254	\$271.47
WDS2188	⊖	9-3/8" X 12-1/4"	238 X 311	\$309.81

Band, Housing and Screw 301 SS

Part Number	Size Range	List Price
2000	Mini kit: 8-1/2 ft. band, 3adj. fasteners, 1 band splicer.	\$9.38
2001	Kit with 100 ft. band, 25 adj. fasteners, 10 band splicers.	\$97.36
2002	Kit with 50 ft. band, 10 adj. fasteners, 5 band splicers.	\$45.93
2003	Box of 25 adj. fasteners.	\$29.94
2004	Box of 10 adj. fasteners.	\$11.98
2005	Box with 100 ft. band and 10 band splicers.	\$70.02
2006	Box with 50 ft. band and 5 band splicers.	\$32.32
2008	Box of 10 band splicers.	\$1.15



SEAL FAST HOSE CLAMPS



Seal Fast Hi-Torque Clamps With Liner

Part Number	Screw Type	Inch Diameter	Metric MM Diameter	List Price/100
Hi-Torque Clamps With Liner, SS301 Band, SS410 Screw				
SF175HTML		1" X 1-3/4"	26 X 45	\$198.55
SF200HTML		1-1/4" X 2-1/8"	32 X 54	\$206.18
SF250HTML		1-3/4" X 2-5/8"	45 X 67	\$212.20
SF300HTML		2-1/4" X 3-1/8"	57 X 80	\$219.62
SF350HTML		2-3/4" X 3-5/8"	70 X 92	\$241.19
SF400HTML		3-1/4" X 4-1/8"	83 X 105	\$262.73
SF450HTML		3-3/4" X 4-5/8"	96 X 118	\$277.10
SF500HTML		4-1/4" X 5-1/8"	108 X 131	\$305.84
SF550HTML		4-3/4" X 5-5/8"	121 X 143	\$323.45
SF600HTML		5-1/4" X 6-1/8"	134 X 156	\$341.79
SF650HTML		5-3/4" X 6-5/8"	146 X 169	\$352.20
SF700HTML		6-1/4" X 7-1/8"	159 X 181	\$359.36
SF750HTML		6-3/4" X 7-5/8"	172 X 194	\$370.53
SF800HTML		7-1/4" X 8-1/8"	184 X 207	\$388.10
SF850HTML		7-3/4" X 8-5/8"	197 X 219	\$406.44
SF900HTML		8-1/4" X 9-1/8"	210 X 232	\$413.69

Seal Fast Hi-Torque H.D. Clamps

Part Number	Screw Type	Inch Diameter	Metric MM Diameter	List Price/100
Hi-Torque H.D. Clamps, SS301 Band, SS410 Screw				
SF200HTM		1-1/4" X 2-1/8"	32 X 54	\$164.35
SF250HTM		1-3/4" X 2-5/8"	45 X 67	\$178.89
SF300HTM		2-1/4" X 3-1/8"	57 X 80	\$200.64
SF350HTM		2-3/4" X 3-5/8"	70 X 92	\$222.39
SF400HTM		3-1/4" X 4-1/8"	83 X 105	\$244.14
SF450HTM		3-3/4" X 4-5/8"	96 X 118	\$258.64
SF500HTM		4-1/4" X 5-1/8"	108 X 131	\$287.63
SF550HTM		4-3/4" X 5-5/8"	121 X 143	\$306.14
SF600HTM		5-1/4" X 6-1/8"	134 X 156	\$323.88
SF650HTM		5-3/4" X 6-5/8"	146 X 169	\$335.14
SF700HTM		6-1/4" X 7-1/8"	159 X 181	\$342.43
SF750HTM		6-3/4" X 7-5/8"	172 X 194	\$352.88
SF800HTM		7-1/4" X 8-1/8"	184 X 207	\$371.43
SF850HTM		7-3/4" X 8-5/8"	197 X 219	\$389.17
SF900HTM		8-1/4" X 9-1/8"	210 X 232	\$396.38



Seal Fast Constant Torque Clamps

Part Number	Screw Type	Inch Diameter	Metric MM Diameter	List Price/100
Constant Torque Clamps, SS301 Band, SS410 Screw				
SF9410CT		9/16" X 1-1/16"	15 X 27	\$419.76
SF9412CT		11/16" X 1-1/4"	18 X 32	\$424.67
SF9416CT		13/16" X 1-1/2"	21 X 38	\$432.71
SF9420CT		13/16" X 1-3/4"	21 X 45	\$437.62
SF9424CT		1-1/16" X 2"	27 X 51	\$441.64
Constant Torque Clamps, Heavy Duty, SS301 Band, SS410 Screw				
SF175CTL		1" X 1-3/4"	26 X 45	\$493.52
SF200CTL		1-1/4" X 2-1/8"	32 X 54	\$503.24
SF250CTL		1-3/4" X 2-5/8"	45 X 67	\$519.15
SF300CTL		2-1/4" X 3-1/8"	57 X 80	\$542.77
SF350CTL		2-3/4" X 3-5/8"	70 X 92	\$558.46
SF400CTL		3-1/4" X 4-1/8"	83 X 105	\$566.31
SF450CTL		3-3/4" X 4-5/8"	96 X 118	\$582.09
SF500CTL		4-1/4" X 5-1/8"	108 X 131	\$589.94
SF550CTL		4-3/4" X 5-5/8"	121 X 143	\$605.67
SF600CTL		5-1/4" X 6-1/8"	134 X 156	\$621.45
SF650CTL		5-3/4" X 6-5/8"	146 X 169	\$637.10
SF700CTL		6-1/4" X 7-1/8"	159 X 181	\$660.72
SF750CTL		6-3/4" X 7-5/8"	172 X 194	\$676.46
SF800CTL		7-1/4" X 8-1/8"	184 X 207	\$700.09
SF850CTL		7-3/4" X 8-5/8"	197 X 219	\$715.78
SF900CTL		8-1/4" X 9-1/8"	210 X 232	\$731.56

Seal Fast Liner Clamps For Soft Silicone

Part Number	Screw Type	Inch Diameter	Metric MM Diameter	List Price/100
Liner Clamp For Soft Silicone, SS301 Band, SS410 Screw				
SF9406		7/16" X 25/32"	12 X 20	\$88.27
SF9408		1/2" X 29/32"	13 X 23	\$89.13
SF9410		9/16" X 1-1/16"	15 X 27	\$90.83
SF9412		11/16" X 1-1/4"	18 X 32	\$96.72
SF9416		13/16" X 1-1/2"	21 X 39	\$102.60
SF9420		13/16" X 1-3/4"	21 X 45	\$110.15
SF9424		1-1/16" X 2"	27 X 51	\$112.71
SF9428		1-5/16" X 2-1/4"	33 X 58	\$118.59
SF9432		1-9/16" X 2-1/2"	40 X 64	\$121.92
SF9436		1-13/16" X 2-3/4"	46 X 70	\$126.99
SF9440		2-1/16" X 3"	53 X 77	\$131.17
SF9444		2-5/16" X 3-1/4"	59 X 83	\$138.76
SF9448		2-9/16" X 3-1/2"	65 X 89	\$142.13
SF9452		2-13/16" X 3-3/4"	72 X 96	\$146.35
SF9456		3-1/16" X 4"	78 X 102	\$153.86
SF9460		3-5/16" X 4-1/4"	84 X 108	\$162.30
SF9464		3-9/16" X 4-1/2"	91 X 115	\$166.48
SF9472		4-1/8" X 5"	105 X 127	\$169.04
SF9480		4-5/8" X 5-1/2"	118 X 140	\$181.62
SF9488		5-1/8" X 6"	130 X 153	\$190.06
SF9496		5-5/8" X 6-1/2"	143 X 165	\$200.13
SF94104		6-1/8" X 7"	156 X 178	\$208.57



SEAL FAST HOSE CLAMPS



! New !

F

Seal Fast Quick Release Clamps 301 SS Band

Inches Diameter	MM Diameter	Carbon Steel Screw		410 Steel Screw	
		Part Number	Price Per Bag (100 Per Bag)	Part Number	Price Per Bag (100 Per Bag)
1-32/64" X 3-32/64"	38 X 89	QR048S	\$126.14	QR048SS	\$140.68
1" X 4"	25 X 102	QR056S	\$137.44	QR056SS	\$151.98
2" X 5"	51 X 127	QR072S	\$156.08	QR072SS	\$170.62
2-4/64" X 6"	52 X 152	QR088S	\$177.91	QR088SS	\$192.41
3-32/64" X 6-36/64"	89 X 167	QR096S	\$190.02	QR096SS	\$204.61
1-48/64" X 7"	44 X 178	QR104S	\$202.13	QR104SS	\$216.72
1-48/64" X 8-36/64"	44 X 218	QR128S	\$232.03	QR128SS	\$246.61
2" X 10"	51 X 254	QR152S	\$266.06	QR152SS	\$280.55
2-4/64" X 12-20/64"	52 X 313	QR188S	\$305.67	QR188SS	\$320.21
10-12/64 X 14"	259 X 356	QR216S	\$339.62	QR216SS	\$354.20
10-48/64 X 16"	273 X 406	QR248S	\$371.98	QR248SS	\$386.48



Seal Fast 2-Ear Clamps

Zinc-Plated

Part Number	Nominal Size	Inches Closed-Open	Metric MM Closed-Open	Price Per Bag 100 Per Bag
POC0507	1/4"	.197" to .276"	05 X 07	\$0.1509
POC0709	5/16"	.276" to .354"	07 X 09	\$0.1651
POC0911	7/16"	.354" to .433"	09 X 11	\$0.1891
POC1113	1/2"	.433" to .512"	11 X 13	\$0.1891
POC1315	9/16"	.512" to .591"	13 X 15	\$0.2170
POC1518	5/8"	.591" to .708"	15 X 18	\$0.2717
POC1720	3/4"	.669" to .787"	17 X 20	\$0.2811
POC2023	7/8"	.787" to .905"	20 X 23	\$0.3943
POC2327	1"	.905" to 1.063"	23 X 25	\$0.4057
POC2831	1-3/16"	1.102" to 1.220"	28 X 31	\$0.4717
POC3134	1-5/16"	1.220" to 1.339"	31 X 37	\$0.4830
POC3740	1-1/2"	1.457" to 1.575"	37 X 40	\$0.6547
POC4043	1-5/8"	1.575" to 1.693"	40 X 43	\$0.6717
POC4346	1-3/4"	1.693" to 1.811"	43 X 46	\$0.8509

Sold in 100 per bag quantities only.

* Repair Tool Charge \$50.00 Plus Freight

		
<p align="center">F38 Locking Tool</p> <p>Portable hand tool used to apply 3/8" & 5/8" Fast-Lok Clamps.</p> <p align="center">List Price \$63.81</p>	<p align="center">F100 Locking Tool (Rev. F-1)</p> <p>Used to apply Punch Type Fast-Lok clamps. Complete with 3/8" adapter. Order mallet separately. For 5/8" and 3/8" wide clamps.</p> <p align="center">List Price \$257.79</p>	<p align="center">F225 Mallet</p> <p>Used for punching of all Fast-Lok clamps.</p> <p align="center">List Price \$52.85</p>
 <p align="center">KS001 Tool</p> <p align="center">KA001 Adapter</p>		
<p>Use for K Clamps, with adapter can be used on 3/4" K Clamps. Also, to apply clamp-it continuous strapping and FL J clamps adapter.</p> <p align="center">KS001 Tool KA001 Adapter</p> <p align="center">List Price \$215.66 List Price \$190.13</p>	<p align="center">F175 Locking Tool</p> <p>Used to apply Fast-Lok 3/4" wide performed clamps.</p> <p align="center">List Price \$651.34</p>	<p align="center">F550 Clamp Cutter</p> <p>Used to remove clamps with minimum effort.</p> <p align="center">List Price \$101.08</p>
		
<p align="center">F40 Locking Tool</p> <p>Use to apply Punch type 3/8" & 5/8" Fast-Lok clamps. Order mallet separately.</p> <p align="center">List Price \$111.11</p>	<p align="center">C2 Orbitor (Locking Tool)</p> <p>Used to apply clamp-it continuous strapping up to 3/4" width.</p> <p align="center">List Price \$340.57</p>	<p align="center">F1580 Clamp Kit</p> <p>Contains one F-40 Clamping Tool and 156 hi-carbon galvanized clamps. Preformed sizes from 1-3/8" to 5" I.D. Open End sizes from 2" to 6" I.D. Heavy Duty Plastic Box.</p> <p align="center">List Price \$420.09</p>

F

Fast-Lok Tool Parts

Part Number	Part Description	Qty Per Tool	List Price Per Tool
FX201	Punch Head	1	\$51.91
F202	Punch	1	\$4.60
F233	Punch Head Pin	1	\$4.62
F206	Pusher Nose	1	\$18.06
F207	Holding Dog	1	\$21.11
F208	Pusher Nose Pin	1	\$4.28
F209	Holding Dog Spring	1	\$2.87
FX211A	Puller Links	2	\$2.92
FX211B	Puller Links	2	\$2.87
F212	Puller Link Pin	1	\$3.94
FY214	Pulling Dog	1	\$27.19
FY217	Pulling Dog Spring	1	\$2.87
F233	Pulling Dog Pin	1	\$4.55
FA220	Ball Handle Assy.	1	\$47.62
F229HT	3/8" Clamp Adapter	1	\$16.58
FA231	Pusher Puller Assy.	1	\$93.21
F242	Retaining Rings	3	\$2.87
F232	Crescent Ring	1	\$2.87
F235	Punch Retainer Ring	1	\$2.87
FY205K	Repair Kit (includes)		\$35.98
FY214	Pulling Dog	1	\$27.19
FY217	Pulling Dog Spring	1	\$2.87
FX211A	Puller Links	2	\$2.92
FX211B	Puller Links	2	\$2.87

Sliding Jack Replacement Kit No. FY205K

(Kit Fits the F1, F100, F175, & the C2 Tools)

Standard "F" Series Preformed Clamps (Punch Type Clamps)

Sold in box quantity only.

High-Carbon Galvanized					Type 301 Stainless Steel		
Clamp Diameter	Clamps Per Pkg.	Band Width & Thickness	Part Number	List Price Per 100 Clamps	Band Width & Thickness	Part Number	List Price Per 100 Clamps
13/16"	100	3/8" x .025"	F3	\$68.70	3/8" x .020"	FS3	\$127.79
1-3/8"	100	3/8" x .025"	F311	\$74.75	3/8" x .020"	FS311	\$144.15
1"	100	5/8" x .025"	F4	\$62.75	5/8" x .022"	FS4	\$138.91
1-1/4"	100	5/8" x .025"	F5	\$80.70	5/8" x .022"	FS5	\$144.91
HEAVY DUTY BANDS							
1-1/2"	100	5/8" x .031"	F6	\$73.87	5/8" x .022"	FS6	\$198.38
1-3/4"	100	5/8" x .031"	F7	\$76.72	5/8" x .022"	FS7	\$182.45
2"	100	5/8" x .031"	F8	\$99.70	5/8" x .022"	FS8	\$230.23
2-1/4"	100	5/8" x .031"	F9	\$104.42	5/8" x .022"	FS9	\$187.81
WITH STAINLESS STEEL LOKS							
2-1/2"	50	5/8" x .031"	F10	\$95.28	5/8" x .022"	FS10	\$260.87
2-3/4"	50	5/8" x .031"	F11	\$126.56	5/8" x .022"	FS11	\$273.83
3"	50	5/8" x .031"	F12	\$134.96	5/8" x .022"	FS12	\$289.79
3-1/2"	50	5/8" x .031"	F14	\$145.92	5/8" x .022"	FS14	\$321.40
4"	25	5/8" x .031"	F16	\$163.32	5/8" x .022"	FS16	\$359.66
4-1/2"	25	5/8" x .031"	F18	\$177.89	5/8" x .022"	FS18	\$293.60
5"	25	5/8" x .031"	F20	\$184.98	5/8" x .022"	FS20	\$420.06
6"	25	5/8" x .031"	F24	\$216.55	5/8" x .022"	FS24	\$362.42
7"	25	5/8" x .031"	F28	\$253.68	5/8" x .022"	FS28	\$408.92
8"	25	5/8" x .031"	F32	\$277.28	5/8" x .022"	FS32	\$601.30

K-Clamp Series Preformed Clamps

Sold in box quantity only.



3/8" and 5/8" (Nominal) Width High-Carbon Electro-Galvanized Steel				
Clamp Diameter	Clamps Per Pkg.	Band Width & Thickness	Part Number	List Price/ 100 Clamps
13/16"	100	3/8" x .025"	K3	\$73.98
1-3/8"	100	3/8" x .025"	K311	\$78.62
1"	100	5/8" x .030"	K4	\$105.57
1-1/4"	100	5/8" x .030"	K5	\$108.92
1-1/2"	100	5/8" x .030"	K6	\$113.81
1-3/4"	100	5/8" x .030"	K7	\$118.21
HEAVY DUTY BANDS				
2"	100	5/8" x .030"	K8	\$122.19
2-1/4"	100	5/8" x .030"	K9	\$127.60
2-1/2"	50	5/8" x .030"	K10	\$134.96
2-3/4"	50	5/8" x .030"	K11	\$143.98
3"	50	5/8" x .030"	K12	\$147.98
3-1/2"	50	5/8" x .030"	K14	\$160.36
4"	25	5/8" x .030"	K16	\$179.57
4-1/2"	25	5/8" x .030"	K18	\$187.30
5"	25	5/8" x .030"	K20	\$199.92
6"	25	5/8" x .030"	K24	\$230.85
7"	25	5/8" x .030"	K28	\$266.94
8"	25	5/8" x .030"	K32	\$281.66

3/8" and 5/8" (Nominal) Width Type 301 Stainless Steel				
Clamp Diameter	Clamps Per Pkg.	Band Width & Thickness	Part Number	List Price/ 100 Clamps
13/16"	100	3/8" x .020"	KS3	\$106.60
1-3/8"	100	3/8" x .020"	KS311	\$116.47
1"	100	5/8" x .022"	KS4	\$164.66
1-1/4"	100	5/8" x .022"	KS5	\$227.72
1-1/2"	100	5/8" x .022"	KS6	\$183.57
1-3/4"	100	5/8" x .022"	KS7	\$191.19
2"	100	5/8" x .022"	KS8	\$279.42
2-1/4"	100	5/8" x .022"	KS9	\$223.96
2-1/2"	50	5/8" x .022"	KS10	\$319.11
2-3/4"	50	5/8" x .022"	KS11	\$346.66
3"	50	5/8" x .022"	KS12	\$366.08
3-1/2"	50	5/8" x .022"	KS14	\$404.53
4"	25	5/8" x .022"	KS16	\$331.42
4-1/2"	25	5/8" x .022"	KS18	\$369.08
5"	25	5/8" x .022"	KS20	\$393.42
6"	25	5/8" x .022"	KS24	\$594.75
7"	25	5/8" x .022"	KS28	\$509.58
8"	25	5/8" x .022"	KS32	\$749.21

3/4" Width x .030 Thick Galvanized Steel				
Clamp Diameter	Clamps Per Pkg.	Band Width & Thickness	Part Number	List Price/ 100 Clamps
2"	100	3/4" X .030"	K87500	\$228.54
2-1/4"	100	3/4" X .030"	K97500	\$232.67
2-1/2"	50	3/4" X .030"	K107500	\$232.70
2-3/4"	50	3/4" X .030"	K117500	\$245.42
3"	50	3/4" X .030"	K127500	\$248.65
3-1/2"	50	3/4" X .030"	K147500	\$260.77
4"	25	3/4" X .030"	K167500	\$285.00
4-1/2"	25	3/4" X .030"	K187500	\$313.88
5"	25	3/4" X .030"	K207500	\$345.58
6"	25	3/4" X .030"	K247500	\$371.23
7"	25	3/4" X .030"	K287500	\$421.89
8"	25	3/4" X .030"	K327500	\$436.34

3/4" Width x .030 Thick Type 301 Stainless Steel				
Clamp Diameter	Clamps Per Pkg.	Band Width & Thickness	Part Number	List Price/ 100 Clamps
2"	100	3/4" X .030"	KS87501	\$298.72
2-1/4"	100	3/4" X .030"	KS97501	\$298.72
2-1/2"	50	3/4" X .030"	KS107501	\$308.85
2-3/4"	50	3/4" X .030"	KS117501	\$321.87
3"	50	3/4" X .030"	KS127501	\$334.30
3-1/2"	50	3/4" X .030"	KS147501	\$362.36
4"	25	3/4" X .030"	KS167501	\$401.23
4-1/2"	25	3/4" X .030"	KS187501	\$443.60
5"	25	3/4" X .030"	KS207501	\$472.72
6"	25	3/4" X .030"	KS247501	\$549.81
7"	25	3/4" X .030"	KS287501	\$635.57
8"	25	3/4" X .030"	KS327501	\$697.83

100' Clamp-it Strapping

Part Number	Width	Thick-ness	Material 100/CTN.	Ship Wt.(lbs)	List Price Per 100' Roll
SS3751	3/8"	.025"	201 Stainless Steel	3.25	\$66.17
SS5001	1/2"	.030"	201 Stainless Steel	5.38	\$124.81
SS6251	5/8"	.030"	201 Stainless Steel	6.50	\$151.62
SS7501	3/4"	.030"	201 Stainless Steel	8.00	\$193.55
SG3750	3/8"	.025"	Galvanized Steel	3.25	\$34.91
SG5000	1/2"	.030"	Galvanized Steel	5.38	\$41.21
SG6250	5/8"	.030"	Galvanized Steel	6.50	\$50.25
SG7500	3/4"	.030"	Galvanized Steel	8.00	\$59.66

Clamps (Buckles)

Sold in box quantity only.

Part Number	Width	Material	Qty./Box Shp. Wt.	List Price Per 100' Roll
CS3751	3/8"	201 Stainless Steel	100/1.0	\$57.66
CS5001	1/2"	201 Stainless Steel	100/1.9	\$70.34
CS6251	5/8"	201 Stainless Steel	100/2.2	\$75.15
CS7501	3/4"	201 Stainless Steel	50/2.1	\$127.92
CG3750	3/8"	Galvanized Steel	100/1.0	\$21.53
CG5000	1/2"	Galvanized Steel	100/1.9	\$31.34
CG6250	5/8"	Galvanized Steel	100/2.2	\$35.83
CG7500	3/4"	Galvanized Steel	50/2.1	\$49.49

F Series Punch Type Clamps Open End

Sold in box quantity only.



F

F Series Punch Type Clamps Open End Galvanized Steel				
Clamp Diameter	Clamps Per Pkg.	Band Width & Thickness	Part Number	List Price/ 100 Clamps
3"	50	5/8" x .031"	FO12	\$181.49
3-1/2"	50	5/8" x .031"	FO14	\$193.74
4"	50	5/8" x .031"	FO16	\$203.66
4-1/2"	50	5/8" x .031"	FO18	\$217.45
5"	25	5/8" x .031"	FO20	\$233.30
6"	25	5/8" x .031"	FO24	\$247.23
7"	25	5/8" x .031"	FO28	\$261.40
8"	25	5/8" x .031"	FO32	\$284.36
9"	25	5/8" x .031"	FO36	\$328.06
10"	25	5/8" x .031"	FO40	\$343.66
12"	25	5/8" x .031"	FO48	\$417.00

F Series Punch Type Clamps Open End Type 301 Stainless Steel				
Clamp Diameter	Clamps Per Pkg.	Band Width & Thickness	Part Number	List Price/ 100 Clamps
3"	50	5/8" x .022"	FOS12	\$387.57
3-1/2"	50	5/8" x .022"	FOS14	\$348.11
4"	50	5/8" x .022"	FOS16	\$370.15
4-1/2"	50	5/8" x .022"	FOS18	\$392.17
5"	25	5/8" x .022"	FOS20	\$421.94
6"	25	5/8" x .022"	FOS24	\$469.74
7"	25	5/8" x .022"	FOS28	\$551.72
8"	25	5/8" x .022"	FOS32	\$617.68
9"	25	5/8" x .022"	FOS36	\$663.19
10"	25	5/8" x .022"	FOS40	\$884.85
12"	25	5/8" x .022"	FOS48	\$830.58

J Series Clamps Require No Hammering

Sold in box quantity only.



J Series Clamps Stainless Steel FLJ Preformed				
Clamp Diameter	Clamps Per Pkg.	Band Width & Thickness	Part Number	List Price/ 100 Clamps
13/16"	100	3/8" x .025"	FLJ201	\$115.60
1"	100	3/8" x .025"	FLJ243	\$123.19
1-3/8"	100	3/8" x .025"	FLJ202	\$126.77
2"	100	3/8" x .025"	FLJ245	\$147.81
3"	100	3/8" x .025"	FLJ246	\$168.45
1"	100	5/8" x .030"	FLJ203	\$215.75
1-1/4"	100	5/8" x .030"	FLJ204	\$225.92
1-1/2"	100	5/8" x .030"	FLJ205	\$232.64
1-3/4"	100	5/8" x .030"	FLJ206	\$242.66
2"	100	5/8" x .030"	FLJ207	\$256.83
2-1/4"	100	5/8" x .030"	FLJ208	\$262.83
2-1/2"	100	5/8" x .030"	FLJ209	\$280.57
2"	100	3/4" X .030"	FLJ227	\$332.91
2-3/4"	50	3/4" X .030"	FLJ210	\$357.49
3"	50	3/4" X .030"	FLJ211	\$378.94
3-1/2"	50	3/4" X .030"	FLJ212	\$408.58
4"	50	3/4" X .030"	FLJ213	\$451.02
4-1/2"	25	3/4" X .030"	FLJ214	\$498.47
5"	25	3/4" X .030"	FLJ215	\$534.85
6"	25	3/4" X .030"	FLJ216	\$607.25
7"	25	3/4" X .030"	FLJ218	\$711.85
8"	25	3/4" X .030"	FLJ219	\$772.53

J Series Clamps Stainless Steel FLJS Smooth I.D.				
Clamp Diameter	Clamps Per Pkg.	Band Width & Thickness	Part Number	List Price/ 100 Clamps
1"	100	5/8" x .030"	FLJS203	\$196.70
1-1/4"	100	5/8" x .030"	FLJS204	\$205.51
1-1/2"	100	5/8" x .030"	FLJS205	\$284.45
1-3/4"	100	5/8" x .030"	FLJS206	\$228.36
2"	100	5/8" x .030"	FLJS207	\$315.23
2-1/4"	100	5/8" x .030"	FLJS208	\$318.70
2-1/2"	100	5/8" x .030"	FLJS209	\$342.04
2"	100	3/4" X .030"	FLJS227	\$289.51
2-3/4"	50	3/4" X .030"	FLJS210	\$441.00
3"	50	3/4" X .030"	FLJS211	\$352.36
3-1/2"	50	3/4" X .030"	FLJS212	\$379.91
4"	50	3/4" X .030"	FLJS213	\$559.26
4-1/2"	25	3/4" X .030"	FLJS214	\$459.60
5"	25	3/4" X .030"	FLJS215	\$664.09
6"	25	3/4" X .030"	FLJS216	\$566.92
7"	25	3/4" X .030"	FLJS218	\$666.87
8"	25	3/4" X .030"	FLJS219	\$729.25



BREEZE CLAMPS



Breeze Clamps

Power Seal General Purpose Industrial Clamps

Part Number	Maximum Diameter	Screw Type	Minimum Diameter	List Price/100
Miniatures 3-Piece Construction 5/16" Band				
03504	5/8"	●	7/32"	\$108.21
03506	25/32"	●	7/16"	\$108.21
03508	29/32"	●	1/2"	\$108.21
03510	1-1/16"	●	9/16"	\$108.21
Full Size 3-Piece Construction 1/2" Band				
62006	25/32"	●	7/16"	\$108.21
62008	29/32"	●	1/2"	\$108.21
62010	1-1/16"	●	9/16"	\$108.21
62012	1-1/4"	●	11/16"	\$108.21
62016	1-1/2"	●	13/16"	\$108.21
62020	1-3/4"	●	13/16"	\$108.21
62024	2"	●	1-1/16"	\$108.21
62028	2-1/4"	●	1-5/16"	\$108.21
62032	2-1/2"	●	1-9/16"	\$108.21
62036	2-3/4"	●	1-13/16"	\$108.21
62040	3"	●	2-1/16"	\$162.40
1/2" Band				
62044	3-1/4"	●	2-5/16"	\$164.79
62048	3-1/2"	●	2-9/16"	\$164.79
62052	3-3/4"	●	2-13/16"	\$192.60
62056	4"	●	3-1/16"	\$192.60
62060	4-1/4"	●	3-5/16"	\$199.60
62064	4-1/2"	●	3-9/16"	\$199.60
62072	5"	●	1-7/8"	\$209.40
62080	5-1/2"	●	2-1/2"	\$240.60
62088	6"	●	3-1/8"	\$246.40
62096	6-1/2"	●	3-5/8"	\$251.21
62104	7"	●	4-1/8"	\$254.60

Band 301SS/Housing 302SS/Screw Carbon Steel

Part Number	Maximum Diameter	Screw Type	Minimum Diameter	List Price/100
Miniatures 200% Stainless Steel 3-Piece Construction 5/16" Band				
03604	5/8"	○	7/32"	\$153.79
03606	25/32"	○	7/16"	\$153.79
03608	15/16"	○	1/2"	\$153.79
03610	1-1/16"	○	9/16"	\$153.79
Full Size Stainless Steel 3-Piece Construction 1/2" Band				
64006	25/32"	○	7/16"	\$146.00
64008	29/32"	○	1/2"	\$146.00
64010	1-1/16"	○	9/16"	\$146.00
64012	1-1/4"	○	11/16"	\$146.00
64016	1-1/2"	○	13/16"	\$146.00
64020	1-3/4"	○	13/16"	\$146.00
64024	2"	○	1-1/16"	\$146.00
64028	2-1/4"	○	1-5/16"	\$146.00
64032	2-1/2"	○	1-9/16"	\$146.00
64036	2-3/4"	○	1-13/16"	\$146.00
64040	3"	○	2-1/16"	\$176.60
64044	3-1/4"	○	2-5/16"	\$205.00
1/2" Band				
64048	3-1/2"	○	2-9/16"	\$205.00
64052	3-3/4"	○	2-13/16"	\$214.21
64056	4"	○	3-1/16"	\$214.21
64060	4-1/4"	○	3-5/16"	\$221.60
64064	4-1/2"	○	3-9/16"	\$221.60
64072	5"	○	1-7/8"	\$232.00
64080	5-1/2"	○	2-1/2"	\$239.40
64088	6"	○	3-1/8"	\$269.40
64096	6-1/2"	○	3-5/8"	\$275.79
64104	7"	○	4-1/8"	\$278.60

Band 301SS/Housing 302SS/Screw 410SS



Make-A-Clamp Universal Clamp Kit

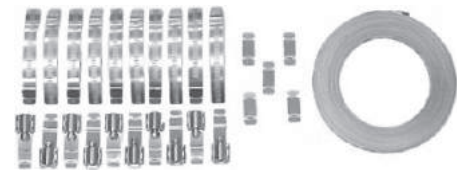

Part Number	Contents	Packed	Wt. Per Ctn.	Part Number	Screw Type	List Price
4000	Retail card, 8 1/2 Ft. band, 3 adj. fasteners, 1 band splice	10 cards/box, 5 boxes (50 cards) per carton	28	4000	○	\$25.42
4001	Kit with 100 Ft. band, 25 adj. fasteners, 10 band splices	6 kits to std. carton	32	4001	○	\$201.19
4002	Kit with 50 Ft. band, 10 adj. fasteners, 5 band splices	6 kits to std. carton	18	4002	○	\$94.26
4003	Box of 25 adj. fasteners	10 boxes to std. ctn. (250 fasteners)	16	4003	○	\$101.57
4004	Box of 10 adj. fasteners	10 boxes to std. ctn. (100 fasteners)	8	4004	○	\$42.30
4005	Box with 100 Ft. band, 10 splices	6 boxes to standard carton	22	4005	○	\$101.57
4006	Box with 50 Ft. band, 5 band splices	6 boxes to standard carton	12	4006	○	\$54.96
4007	6" demonstrator disc with clamp	Packed by the unit	4 oz.	4007	○	\$11.53
4008	Box of 10 band splices (100 per ctn.)	10 boxes (100 band splices)	13 oz.	4008	○	\$3.96



BREEZE CLAMPS



Breeze Clamps

Part Number	Maximum Diameter	Screw Type	Minimum Diameter	List Price/100
Miniatures 4-Piece Construction 5/16" Band				
06504	5/8"		7/32"	\$182.21
06506	25/32"		7/16"	\$182.21
06508	15/16"		1/2"	\$204.40
06510	1-1/16"		9/16"	\$204.40
Full Size 4-Piece Heavy Duty Construction 9/16" Band				
100 06H	25/32"		7/16"	\$218.60
100 08H	29/32"		1/2"	\$218.60
100 10H	1-1/16"		9/16"	\$218.60
100 12H	1-1/4"		11/16"	\$225.40
100 16H	1-1/2"		13/16"	\$225.40
100 20H	1-3/4"		13/16"	\$228.60
100 24H	2"		1-1/16"	\$228.60
100 28H	2-1/4"		1-5/16"	\$234.60
100 32H	2-1/2"		1-9/16"	\$234.60
100 36H	2-3/4"		1-13/16"	\$242.00
100 40H	3"		2-1/16"	\$299.60
100 44H	3-1/4"		2-5/16"	\$325.60
100 48H	3-1/2"		2-9/16"	\$325.60
100 52H	3-3/4"		2-13/16"	\$347.00
100 56H	4"		3-1/16"	\$347.00
100 60H	4-1/4"		3-5/16"	\$360.21
100 64H	4-1/2"		3-9/16"	\$360.21
100 72H	5"		1-7/8"	\$398.00
100 80H	5-1/2"		2-1/2"	\$438.60
100 88H	6"		3-1/8"	\$466.21
100 96H	6-1/2"		3-5/8"	\$480.00
100 104H	7"		4-1/8"	\$493.40
100 128H	8-1/2"		5-5/8"	\$588.40
100 152H	10"		7-1/8"	\$636.79
100 188H	12-1/4"		9-3/8"	\$694.60

Band 301SS/Housing 302SS/Screw Carbon Steel

Aero-Seal Industrial Clamps

Part Number	Maximum Diameter	Screw Type	Minimum Diameter	List Price/100
Miniatures Stainless Steel 4-Piece Construction 5/16"				
06604	5/8"		7/32"	\$226.42
06606	25/32"		7/16"	\$226.42
06608	15/16"		1/2"	\$254.72
06610	1-1/16"		9/16"	\$254.72
Full Size Stainless Steel 4-Piece Construction 9/16" Band				
200 06H	25/32"		7/16"	\$275.47
200 08H	29/32"		1/2"	\$275.47
200 10H	1-1/16"		9/16"	\$275.47
200 12H	1-1/4"		11/16"	\$281.13
200 16H	1-1/2"		13/16"	\$281.13
200 20H	1-3/4"		13/16"	\$286.79
200 24H	2"		1-1/16"	\$286.79
200 28H	2-1/4"		1-5/16"	\$288.68
200 32H	2-1/2"		1-9/16"	\$288.68
200 36H	2-3/4"		1-13/16"	\$300.00
200 40H	3"		2-1/16"	\$362.26
200 44H	3-1/4"		2-5/16"	\$386.79
200 48H	3-1/2"		2-9/16"	\$396.23
200 52H	3-3/4"		2-13/16"	\$415.09
200 56H	4"		3-1/16"	\$424.53
200 60H	4-1/4"		3-5/16"	\$424.53
200 64H	4-1/2"		3-9/16"	\$467.92
200 72H	5"		1-7/8"	\$467.92
200 80H	5-1/2"		2-1/2"	\$541.51
200 88H	6"		3-1/8"	\$550.94
200 96H	6-1/2"		3-5/8"	\$558.49
200 104H	7"		4-1/8"	\$567.92
200 128H	8-1/2"		5-5/8"	\$703.77
200 152H	10"		7-1/8"	\$762.26
200 188H	12-1/4"		9-3/8"	\$824.53

Band 301SS/Housing 302SS/Screw 410SS



Hi-Torque-H.D. Clamps

Part Number	Maximum Diameter	Screw Type	Minimum Diameter	List Price/100
HTM 200	2-1/8"		1-1/4"	\$571.70
HTM 250	2-5/8"		1-3/4"	\$584.91
HTM 300	3-1/8"		2-1/4"	\$605.66
HTM 350	3-5/8"		2-3/4"	\$611.32
HTM 400	4-1/8"		3-1/4"	\$630.19
HTM 450	4-5/8"		3-3/4"	\$643.40
HTM 500	5-1/8"		4-1/4"	\$667.92
HTM 550	5-5/8"		4-3/4"	\$716.98
HTM 600	6-1/8"		5-1/4"	\$735.85
HTM 700	7-1/8"		6-1/4"	\$764.15
HTM 750	7-5/8"		6-3/4"	\$830.19
HTM 850	8-5/8"		7-3/4"	\$867.92
HTM 900	9-1/8"		8-1/4"	\$886.79

Stainless Band/Carbon Screw

Hi-Torque Clamps With Liner

Part Number	Maximum Diameter	Screw Type	Minimum Diameter	List Price/100
HTM 175L	1-3/4"		1"	\$581.60
HTM 200L	2-1/8"		1-1/4"	\$581.61
HTM 250L	2-5/8"		1-3/4"	\$589.00
HTM 300L	3-1/8"		2-1/4"	\$611.60
HTM 350L	3-5/8"		2-3/4"	\$623.21
HTM 400L	4-1/8"		3-1/4"	\$642.00
HTM 450L	4-5/8"		3-3/4"	\$657.00
HTM 500L	5-1/8"		4-1/4"	\$679.79
HTM 550L	5-5/8"		4-3/4"	\$725.21
HTM 600L	6-1/8"		5-1/4"	\$744.21
HTM 650L	6-5/8"		5-3/4"	\$751.79
HTM 700L	7-1/8"		6-1/4"	\$778.21
HTM 750L	7-5/8"		6-3/4"	\$838.79
HTM 800L	8-1/8"		7-1/4"	\$857.60
HTM 850L	8-5/8"		7-3/4"	\$872.79
HTM 900L	9-1/8"		8-1/4"	\$895.40

Stainless Band/Stainless Screw



BREEZE CLAMPS



F

Liner Clamps for Soft/Silicone

Constant-Torque Clamps

Part Number	Maximum Diameter	Minimum Diameter	List Price/100
9406	25/32"	7/16"	\$312.60
9408	29/32"	1/2"	\$312.60
9410	1-1/16"	9/16"	\$312.60
9412	1-1/4"	11/16"	\$320.21
9416	1-1/2"	13/16"	\$320.21
9420	1-3/4"	13/16"	\$324.21
9424	2"	1-1/16"	\$324.21
9428	2-1/4"	1-5/16"	\$328.00
9432	2-1/2"	1-9/16"	\$328.00
9436	2-3/4"	1-13/16"	\$339.40
9440	3"	2-1/16"	\$411.79
9444	3-1/4"	2-5/16"	\$429.60
9448	3-1/2"	2-9/16"	\$443.00
9452	3-3/4"	2-13/16"	\$456.21
9456	4"	3-1/16"	\$456.21
9460	4-1/4"	3-5/16"	\$469.40
9464	4-1/2"	3-9/16"	\$469.40
9472	5"	4-1/8"	\$512.21
9480	5-1/2"	4-5/8"	\$587.21
9488	6"	5-1/8"	\$601.40
9496	6-1/2"	5-5/8"	\$606.00
94104	7"	6-1/8"	\$615.40

Part Number	Maximum Diameter	Minimum Diameter	List Price/100
AERO-SEAL construction for use on small diameter applications - torque rated 30-70 in./lbs..			
CT 9410	1-1/16"	9/16"	\$1044.21
CT 9412	1-1/4"	11/16"	\$1080.00
CT 9416	1-1/2"	13/16"	\$1112.21
CT 9420	1-3/4"	13/16"	\$1147.79
CT 9424	2"	1-1/16"	\$1180.40
Heavy duty construction for use on large diameter applications - torque rated 50-125 in./lbs..			
CT 175L	1-3/4"	1"	\$1483.60
CT 200L	2-1/8"	1-1/4"	\$1483.60
CT 250L	2-5/8"	1-3/4"	\$1492.21
CT 300L	3-1/8"	2-1/4"	\$1517.60
CT 350L	3-5/8"	2-3/4"	\$1530.79
CT 400L	4-1/8"	3-1/4"	\$1552.00
CT 450L	4-5/8"	3-3/4"	\$1569.00
CT 500L	5-1/8"	4-1/4"	\$1594.60
CT 550L	5-5/8"	4-3/4"	\$1645.79
CT 600L	6-1/8"	5-1/4"	\$1667.21
CT 650L	6-5/8"	5-3/4"	\$1676.00
CT 700L	7-1/8"	6-1/4"	\$1705.79
CT 750L	7-5/8"	6-3/4"	\$1774.00
CT 800L	8-1/8"	7-1/4"	\$1795.40
CT 850L	8-5/8"	7-3/4"	\$1812.40
CT 900L	9-1/8"	8-1/4"	\$1838.00

Liner Clamps for Soft/Silicone

Integral extension of the band as a liner (no rivets or welds). Protects soft surface hose (silicone and others) from damage caused by extrusion or shearing through the band slots. Breeze liner clamps give the truest concentric seal of any clamp made.

Breeze Constant-Torque clamps are designed to stop or greatly minimize hose cold-flow leaks. Typical applications are sealed systems where clamps cannot be re-tightened, systems where clamps are difficult to get to, applications require higher torque, large diameters, extremes of heat or cold, or system expansion or contraction. Constant-Torque clamps are specifically recommended for bus, truck, and heavy duty equipment, air intake and coolant connections. Standard Constant-Torque are designed for torque compensation at installation torques from 50 to 125 inch/lbs.. However, Constant-Torque clamps can be custom engineered for greater or lesser stress/load factors, to customer specifications.



OETIKER CLAMPS



Oetiker 2-Ear Clamps

Zinc-Plated

Old Part Number	New Part Number	Nominal Size	Inches Closed-Open	List Price Per 100	Pieces Per Bag
0041	10100000	5/32"	.122" to .161"	\$58.49	100
0045	10100001	11/64"	.138" to .177"	\$58.49	100
0305	10100002	3/16"	.118" to .197"	\$58.49	100
0507	10100004	1/4"	.197" to .276"	\$60.38	100
0709	10100008	5/16"	.276" to .354"	\$59.92	100
0811	10100011	3/8"	.315" to .433"	\$60.17	100
-	-	-	-	--	-
1113	10100016	1/2"	.433" to .512"	\$61.40	100
1315	10100019	9/16"	.512" to .591"	\$65.57	100
1517	10100022	19/32"	.591" to .669"	\$66.32	100
1518	10100024	5/8"	.591" to .708"	\$66.32	100
1720	10100027	3/4"	.669" to .787"	\$72.23	100
1922	10100029	13/16"	.748" to .866"	\$131.15	100
2023	10100030	7/8"	.787" to .905"	\$82.51	100
2225	10100032	15/16"	.866" to .984"	\$153.62	100
2327	10100034	1"	.905" to .063"	\$97.98	100
2528	10100035	1-1/16"	.984" to 1.102"	\$104.13	100
2731	10100037	1-1/8"	1.063" to 1.220"	\$107.60	100
-	-	-	-	--	-
3134	10100041	1-5/16"	1.220" to 1.339"	\$172.89	100
3437	10100043	1-7/16"	1.339" to 1.457"	\$119.89	100
3740	10100045	1-1/2"	1.457" to 1.575"	\$209.11	100
4043	10100047	1-5/8"	1.575" to 1.693"	\$264.40	100
4346	10100049	1-3/4"	1.693" to 1.811"	\$244.75	100

Sold in bag or carton quantities only.

F

Oetiker 2-Ear Clamps



304 Stainless

Old Part Number	New Part Number	Nominal Size	Inches Closed-Open	List Price Per 100	Pieces Per Bag
0041R	15100000	5/32"	.122" to .161"	\$73.91	100
0305R	15100002	3/16"	.118" to .197"	\$73.91	100
0507R	15100003	1/4"	.197" to .276"	\$77.36	100
0709R	15100004	5/16"	.276" to .354"	\$80.83	100
0811R	15100023	3/8"	.315" to .433"	\$81.30	100
-	-	-	-	--	-
1113R	15100006	1/2"	.433" to .512"	\$86.94	100
1315R	15100007	9/16"	.512" to .591"	\$90.38	100
1517R	15100008	19/32"	.591" to .669"	\$100.21	100
1518R	15100009	5/8"	.591" to .708"	\$106.60	100
1720R	15100010	3/4"	.669" to .787"	\$119.36	100
1922R	15100011	13/16"	.748" to .866"	\$122.32	100
2023R	15100012	7/8"	.787" to .905"	\$132.15	100
2225R	15100013	15/16"	.866" to .984"	\$137.55	100
2327R	15100014	1"	.905" to 1.063"	\$147.15	100
2528R	15100015	1-1/16"	.984" to 1.102"	\$156.45	100
2731R	15100016	1-1/8"	1.063" to 1.220"	\$166.06	100
-	-	-	-	--	-
3134R	15100018	1-5/16"	1.220" to 1.339"	\$184.68	100
3437R	15100019	1-7/16"	1.339" to 1.457"	\$194.04	100
3740R	15100020	1-1/2"	1.457" to 1.575"	\$203.40	100
4043R	15100021	1-5/8"	1.575" to 1.693"	\$212.47	100
4346R	15100022	1-3/4"	1.693" to 1.811"	\$222.30	100

Sold in bag or carton quantities only.

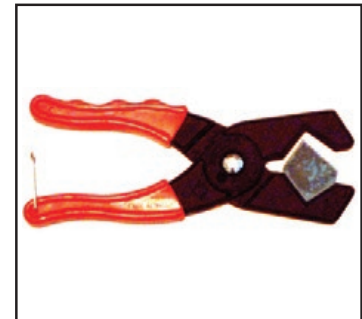

Oetiker Hose Cutter

Part Number	List Price
14100078	\$93.66
Replacement Blades (2 per package)	
Part Number	List Price
14100079	\$50.96

Pincers For Oetiker 2-Ear Clamps

	New Part Number	Description	Weight	List Price
	14100118	Straight Jaw Pincers	1 lb.	\$82.06
	14100083	Side Jaw Pincers	1 lb.	\$61.89
	--	--	--	--



OETIKER CLAMPS

Oetiker 1-Ear Clamps

Zinc-Plated

Oetiker 1-Ear Clamps are intended for low pressure applications such as automotive, appliances, industrial machinery, underground irrigation systems, etc. They are specifically designed for mass production applications where inexpensive clamps are needed.

Oetiker has the ear with a "dimple". This simple design difference not only adds increased strength to the grip of the clamp, it also creates a spring-like action which permits the clamps to "breathe" without loosening. We also believe that the mechanical look of the Oetiker 1-Ear Clamp is superior to any other joint. Spotwelding techniques are not used and therefore the possibility of failure due to corrosion at the spot weld is eliminated.

PRESSURE: As a guideline, Oetiker 1-Ear Clamps (210R) have held 30 bar -441 psi. This was done using a static water pressure test.

MATERIALS: Zinc plated clamps are made of 1008/1010 carbon steel, hot dipped and galvanized to designation G90 (ASTM A 525). It will withstand a salt spray test of 96 hours.

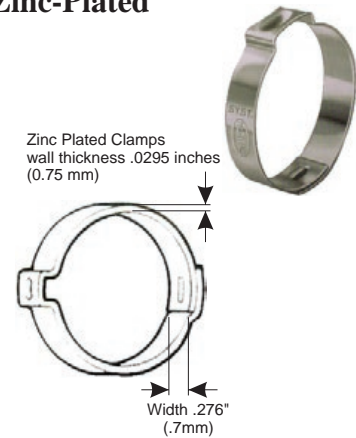

Old Part Number	New Part Number	Nominal Size	Inches Closed-Open	List Price Per 100	Pieces Per Bag
105	10500000	3/8"	.350" to .414"	\$29.94	100
113	10500001	7/16"	.381" to .444"	\$29.94	100
123	10500002	15/32"	.394" to .486"	\$29.94	100
133	10500003	1/2"	.453" to .524"	\$29.94	100
140	10500006	35/64"	.472" to .551"	\$30.23	100
145	10500007	9/16"	.496" to .571"	\$30.23	100
157	10500008	5/8"	.543" to .618"	\$30.23	100
170	10500009	11/16"	.594" to .669"	\$30.23	100
185	10500010	23/32"	.618" to .728"	\$30.23	100
198	10500011	3/4"	.669" to .779"	\$30.70	100
210	10500012	13/16"	.716" to .827"	\$31.45	100
226	10500013	7/8"	.779" to .890"	\$31.94	100
241	10500014	15/16"	.839" to .949"	\$32.42	100
256	10500015	1"	.898" to 1.008"	\$32.91	100
271	10500016	1-1/16"	.945" to 1.067"	\$33.66	100
286	10500017	1-1/8"	1.004" to 1.126"	\$34.62	100
301	10500018	1-3/16"	1.063" to 1.185"	\$35.38	100
316	10500019	1-1/4"	1.122" to 1.244"	\$36.09	100
331	10500020	1-5/16"	1.181" to 1.303"	\$36.85	100
346	10500021	1-3/8"	1.240" to 1.362"	\$37.81	100
361	10500022	1-7/16"	1.299" to 1.421"	\$38.81	100
376	10500023	1-15/32"	1.358" to 1.480"	\$39.77	100
381	10500024	1-1/2"	1.378" to 1.500"	\$41.30	100
396	10500025	1-9/16"	1.437" to 1.559"	\$42.02	100
410	10500026	1-5/8"	1.492" to 1.614"	\$42.74	100
425	10500027	1-11/16"	1.551" to 1.673"	\$43.98	100
440	10500028	1-23/32"	1.610" to 1.732"	\$44.66	100
455	10500029	1-3/4"	1.669" to 1.791"	\$45.70	100
470	10500030	1-13/16"	1.728" to 1.850"	\$47.42	100
485	10500031	1-7/8"	1.787" to 1.909"	\$48.38	100
500	10500032	1-15/16"	1.846" to 1.968"	\$49.81	100
515	10500033	2"	1.905" to 2.028"	\$50.85	100
530	10500034	2-1/16"	1.965" to 2.087"	\$52.32	100
545	10500035	2-1/8"	2.024" to 2.146"	\$53.57	100
560	10500036	2-3/16"	2.083" to 2.205"	\$54.77	100



OETIKER CLAMPS

Oetiker Service Kits

18500056 - With Standard Jaw Pincers



Service Kits
 Plastic kit box contains:
 Standard Jaw Pincers
 Part # 1098
 All Zinc plated
 2-Ear Clamps:
 15 of 0709 (5/16")
 15 of 0911 (7/16")
 15 of 1113 (1/2")
 15 of 1315 (9/16")
 15 of 1518 (5/8")
 15 of 1720 (3/4")
 15 of 2023 (7/8")
 15 of 2225 (15/16")
 15 of 2327 (1")

Part Number	Description	List Price
18500056	Service Kit With Standard Jaw Pincers	\$213.87

18500049 - With Standard Jaw Pincers



Pocket Kit
 Plastic kit box contains:
 Standard Jaw Pincers
 Part# 1098
 Zinc Plated
 2-Ear Clamps:
 15 of 1113 (1/2")
 15 of 1315 (9/16")
 15 of 1518 (5/8")
 15 of 1720 (3/4")
 Stainless Steel
 Hose Menders:
 5 of 406R (1/4")
 5 of 408R (5/16")

Part Number	Description	List Price
18500049	Pocket Kit With Standard Jaw Pincers	\$198.28

Please Note:

Once an Oetiker Eared Clamp has been applied, then removed, it **must not be reused**.

Installation:



When installing Oetiker 2-Ear Clamps, close first ear, then the second. Once the second ear is closed, the first one will open slightly, simply squeeze again. Do not squeeze each ear more than twice. On Stepless Ear Clamps, simply close the single ear.



With either clamp, if properly sized, the ear will spring back naturally to provide a desired gap of approximately 1.5 mm. That is necessary for Oetiker eared clamps to perform to their maximum. If clamp ears can be closed all the way, the clamp size selected is too big and the next smaller size clamp should be ordered.

How To Apply:

This procedure works for either eared clamp. Position clamp on hose as illustrated.



Give each ear a firm squeeze with your Oetiker Pincers.



Where access to ear is difficult use Oetiker's Side Jaw Pincers Model 1099.



How To Remove:

Grip the outer edge of ear firmly and cut through it with either pincers.



Cut the ear by taking several small bites at its base with either pincers. Then grip ear firmly and twist it off.



Stepless clamps may be easily removed by prying end up with a common screwdriver.



F

Banjo Polypropylene Dry Disconnect



Dry Mate ®

Size	Part Number	List Price
1-1/2"	DM 150A	\$277.36
1-1/2"	DM 150D	\$295.02
2"	DM 200A	\$277.36
2"	DM 200D	\$295.06
2"	DM 200CAP	\$83.49
2"	DM 200PL	\$83.49

FEATURES:

- . Lightweight
- . Unrestricted 1-1/2" flow
- . Minimal fluid spillage
- . Easy to use
- . Economical
- . Reduces risk of exposure
- . Wide range of chemical resistance
- . Cannot be uncoupled in open position
- . 100 psi @ 75°F
- . 70 psi @ 150°F

DESIGN: The Banjo Dry-Mate is designed for safe and easy spill free connections. The "double ball" design allows maximum flow, while the cam lever style of connection is the most recognized fluid connector.

Spillage Data:

- 1-1/2" = 2ml.
- 2" = 2ml.



User friendly: Operating Dry-Mate is simple. The handles interlock making it easy to identify which handle opens or closes first. No guessing involved! The two Dry-Mate halves couple together with cam levers for positive engagement.



"Stubby Valve"™



VSMT200

FEATURES:

- . All PTFE, Seals.
- . Stainless steel bolts.
- . Glass filled polypropylene.
- . Maximum operating pressure
100 P.S.I. @ 70°F. 75 P.S.I. @ 150°F.
- . Unique patented compact design.
- . Lightweight
- . Three design options.

Part Number	Description	Opening Thru Ball	List Price
VSF200	2" Male Adapter x 2" Female NPT Thread	1-1/2"	\$73.58

Part Number	Description	Opening Thru Ball	List Price
VSMT200	2" Male NPT Thread x 2" Female NPT Thd	1-1/2"	\$73.58

Part Number	Description	Opening Thru Ball	List Price
VSFMT200	2" Male Adapter x 2" Male NPT Thread	1-1/2"	\$79.25

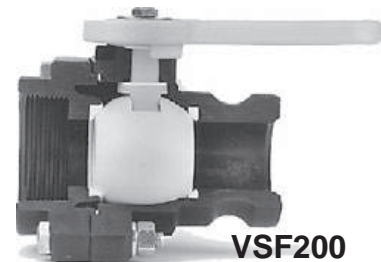

VSF200

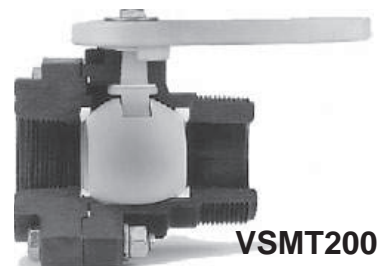

VSMT200

Banjo Polypropylene

A Female Adapter x Female NPT				B *Coupler x Male NPT			
	Size	Polypropylene Part Number	List Price		Size	Polypropylene Part Number	List Price
	3/4"	075A PP	\$6.32		3/4"	075B PP	\$14.45
	1"	100A PP	\$6.32		1"	100B PP	\$16.60
	1-1/4"	125A PP	\$6.32		1-1/4"	125B PP	\$16.60
	1-1/2"	150A PP	\$7.18		1-1/2"	150B PP	\$19.46
	2"	200A PP	\$8.46		2"	200B PP	\$23.69
	3"	300A PP	\$20.44		3"	300B PP	\$39.82
	4"	400A PP	\$31.17		4"	400B PP	\$78.91
C *Coupler x Hose Shank				D *Coupler x Female NPT			
	Size	Polypropylene Part Number	List Price		Size	Polypropylene Part Number	List Price
	3/4"	075C PP	\$14.45		3/4"	075D PP	\$14.45
	1"	100C PP	\$16.60		1"	100D PP	\$16.60
	1-1/4"	125C PP	\$16.60		1-1/4"	125D PP	\$16.60
	1-1/2"	150C PP	\$19.43		1-1/2"	150D PP	\$19.46
	2"	200C PP	\$23.69		2"	200D PP	\$23.69
	3"	300C PP	\$39.82		3"	300D PP	\$39.82
	4"	400C PP	\$78.91		4"	400D PP	\$78.91
E Adapter x Hose Shank				F Adapter x Male NPT			
	Size	Polypropylene Part Number	List Price		Size	Polypropylene Part Number	List Price
	3/4"	075E PP	\$6.82		3/4"	075F PP	\$6.82
	1"	100E PP	\$7.57		1"	100F PP	\$7.57
	1-1/4"	125E PP	\$7.57		1-1/4"	125F PP	\$7.57
	1-1/2"	150E PP	\$7.60		1-1/2"	150F PP	\$7.60
	2"	200E PP	\$9.98		2"	200F PP	\$9.98
	3"	300E PP	\$26.18		3"	300F PP	\$26.18
	4"	400E PP	\$31.17		4"	400F PP	\$31.17
DC *Coupler Dust Cap				DP Adapter Dust Plug			
	Size	Polypropylene Part Number	List Price		Size	Polypropylene Part Number	List Price
	3/4"	075DC PP	\$14.45		3/4"	075DP PP	\$6.82
	1"	100DC PP	\$15.94		1"	100DP PP	\$6.57
	1-1/4"	125DC PP	\$15.94		1-1/4"	125DP PP	\$6.57
	1-1/2"	150DC PP	\$19.46		1-1/2"	150DP PP	\$7.34
	2"	200DC PP	\$23.69		2"	200DP PP	\$9.80
	3"	300DC PP	\$39.82		3"	300DP PP	\$20.76
	4"	400DC PP	\$57.56		4"	400DP PP	\$24.50

*3"C and all 4" Poly couplers have 3 handles. * Dust Caps and Dust Plugs are not recommended for pressure applications.

Spool Adapters



Spool Adapters

Part Number	Size	List Price
200FF	2" Male Adapter - 2" Male Adapter	\$26.05
300F200F	3" Male Adapter - 2" Male Adapter	\$52.15
300FF	3" Male Adapter - 3" Male Adapter	\$52.15



Poly Cam Lever Couplings

Part Number	Size	List Price
201B	2" Female Coupler - 2" Extended Male Thread	\$23.69
303B	3" Female Coupler - 3" Extended Male Thread	\$51.08



3" w/3 Arms Poly Cam Lever Coupling

Part Number	Description	List Price
303B200A	3" Female Coupler w/3 Arms - 2" Male Adapter	\$71.11



Banjo Polypropylene

Ball Valves



Size	Part Number	List Price
1/2"	V 050	\$47.55
3/4"	V 075	\$47.55
1"	V 100	\$47.92
1"	V 100 FP	\$53.06
1-1/4"	V 125	\$53.06
1-1/4"	V 125 FP	\$68.49
1-1/2"	V 150 FP	\$68.49
2"	V 200	\$67.91
2"	V 200 FP	\$95.74
3"	V 300	\$155.40
3"	V 300 FP	\$230.15
4"	V 400	\$500.70
1"	VA 100	\$53.43
1-1/2"	VA 150	\$78.28
2"	VA 200	\$78.28
2 x 1-1/2"	VA 200/150	\$80.55
2"	VA 200 FP	\$119.83

FP = Full Port
VA = Angle Valve

Valves and Nozzle

FEATURES:

- Precision molded in polypropylene. Polypropylene is reinforced with fiberglass for additional strength.
- Self-aligning ball moves freely against the PTFE seats for smooth operation. The valve opens and closes with very little pressure on the handle.
- Ball is diamond turned after molding to make it spherically perfect, which provides the right contact between ball and seats.
- Viton "O" ring stem seal.
- PTFE self-lubricating stem bushings and seats cannot stick or rust.
- Stainless steel nuts and bolts are used to insure easy disassembly in corrosive conditions.
- Maximum operating pressure 100 P.S.I.
- Sizes 1/2" thru 2" have a four bolt construction. 2" full port, and 3" full port have six bolt construction. All have Viton O-Rings and PTFE seats as a standard.
- Lightweight hose end valve for convenient transfer of liquids. Angle and flange with 8" long polypropylene fill spout. Same features as straight through valve.

G

Part Number	Description	List Price
V20153	Handle for V125-FP, V150, VA150, V200, VA200	\$10.70
V25153	Handle for V200-FP, VA200-FP	\$16.57
VL20153	Locking Device for V125FP, V150, V200	\$18.68
VL25153	Locking Handle for V200FP, V300, V300FP, V400	\$37.26

Part Number	Description	List Price
VFMT200FP	2" Valve 2" Male Adapter X 2" Male NPT Thread	\$109.34

Part Number	Description	List Price
VFMT204FP	2" Valve 2" Male NPT Thread X 2" Male Adapter	\$100.72

FEATURES:

- Precision molded in polypropylene. Polypropylene is reinforced with fiberglass for additional strength.
- Self-aligning ball moves freely against the PTFE seats for smooth operation. The valve opens and closes with very little pressure on the handle.
 - Ball is diamond turned after molding to make it spherically perfect, which provides the right contact between ball and seats.
 - Viton "O" ring stem seal.
 - PTFE self-lubricating stem bushings and seats cannot stick or bind.
 - Stainless steel nuts and bolts .
 - Maximum operating pressure 100 P.S.I @ 70°F and 75 P.S.I. @ 150°F .



FEATURES:

- 2" full port, 4 bolt design.
- All stainless steel hardware.
- Precision molded in glass filled polypropylene.
- Viton seals.
- 100% PTFE ball seats.
- Stainless steel nuts and bolts .
- 100 P.S.I maximum @ 70°F and 75 P.S.I. @ 150°F .



Polypropylene Nozzle



FEATURES:

- Glass filled polypropylene.
- Stainless steel handle, spring and pin.
- Viton® rubber parts.
- Resists corrosion.
- Padlock capability
- 75 P.S.I. maximum.
- 40 G.P.M.

Part Number	Description	Pipe Size	Female NPT Thread	List Price
VN 100	Poly Nozzle Valve	1"	1"	\$87.41

Polypropylene Class 150 Ansi Flanges

Bolted Tank Flange

Part Number	Description	Pipe Size	List Price
BF100PP	1" X 1-1/2" Threaded Flange	1"	\$57.52
BF150PP	1-1/2" X 2" Threaded Flange	1-1/2"	\$47.18
BF200PP	2" X 2" Threaded Flange	2"	\$47.18
BF300PP	3" X 3" Threaded Flange	3"	\$84.21
EPDM Gasket Included			



FEATURES:

- Glass reinforced for stability, strength and durability.
- Precision molded solid, one-piece construction.
- 150 P.S.I. maximum operating pressure.

Threaded Flange

Part Number	Description	Pipe Size	List Price
AF100PP	1" Threaded Flange	1"	\$16.03
AF150PP	1-1/2" Threaded Flange	1-1/2"	\$30.76
AF200PP	2" Threaded Flange	2"	\$35.89
AF300PP	3" Threaded Flange	3"	\$57.35
AF400PP	4" Threaded Flange	4"	\$121.23



★ Gasket sold separately.

Blind Flange (Blank Flange)

Part Number	Description	List Price
AFB100PP	1" Blind Flange	\$22.69
AFB150PP	1-1/2" Blind Flange	\$34.71
AFB200PP	2" Blind Flange	\$43.14
AFB300PP	3" Blind Flange	\$75.85
AFB400PP	4" Blind Flange	\$132.49

POLY BULKHEAD FITTINGS W/VITON (FKM)

Part Number	Description	Hole Size	List Price
TF050V	1/2" Poly Bulkhead Tank Fitting	1-5/8"	\$24.42
TF075V	3/4" Poly Bulkhead Tank Fitting	1-5/8"	\$24.42
TF100V	1" Poly Bulkhead Tank Fitting	2-1/4"	\$32.60
TF125V	1"-1/4" Poly Bulkhead Tank Fitting	2-1/4"	\$32.60
TF150V	1"-1/2" Poly Bulkhead Tank Fitting	3"	\$40.10
TF200V	2" Poly Bulkhead Tank Fitting	3"	\$45.33
TF220V	2" Poly Bulkhead Tank Fitting	3-1/4"	\$34.01
TF300V	3" Poly Bulkhead Tank Fitting	4-1/2"	\$110.25
TF400V	4" Poly Bulkhead Tank Fitting	5-3/4"	\$257.32



FEATURES:

- Double sided female NPT threads.
- Available in Viton gasket.

POLY BULKHEAD FITTINGS W/EPDM

Part Number	Description	Hole Size	List Price
TF050	1/2" Poly Bulkhead Tank Fitting	1-5/8"	\$12.45
TF075	3/4" Poly Bulkhead Tank Fitting	1-5/8"	\$12.45
TF100	1" Poly Bulkhead Tank Fitting	2-1/4"	\$15.09
TF125	1"-1/4" Poly Bulkhead Tank Fitting	2-1/4"	\$17.36
TF150	1"-1/2" Poly Bulkhead Tank Fitting	3"	\$26.79
TF200	2" Poly Bulkhead Tank Fitting	3"	\$26.79
TF220	2" Poly Bulkhead Tank Fitting	3-1/4"	\$34.25
TF300	3" Poly Bulkhead Tank Fitting	4-1/2"	\$56.85
TF400	4" Poly Bulkhead Tank Fitting	5-3/4"	\$155.76



FEATURES:

- Double sided female NPT threads.
- Available in EPDM gasket.

316 STAINLESS BULKHEAD FITTINGS W/EPDM

Part Number	Description	Hole Size	List Price
TF075SS	3/4" Poly Bulkhead Tank Fitting	1-5/8"	\$237.20
TF100SS	1" Poly Bulkhead Tank Fitting	2-1/4"	\$288.71
TF125SS	1"-1/4" Poly Bulkhead Tank Fitting	2-1/4"	\$288.71
TF150SS	1"-1/2" Poly Bulkhead Tank Fitting	3"	\$362.69
TF200SS	2" Poly Bulkhead Tank Fitting	3"	\$362.69
TF220SS	2" Poly Bulkhead Tank Fitting	3-1/4"	\$382.83
TF300SS	3" Poly Bulkhead Tank Fitting	4-3/8"	\$586.56



FEATURES:

- Double sided female NPT threads.
- Available in EPDM gasket.

Banjo Polypropylene 90° Cam and Groove

<h3>A 90°</h3>	Size	Part Number	List Price	<h3>C 90°</h3>	Size	Part Number	List Price
	1-1/2"	150A90	\$11.31		1-1/2"	150C90	\$23.30
	2"	200A90	\$12.91		2"	200C90	\$28.91
Male Adapter x Female NPT				Female Coupler x Hose Shank			
<h3>D 90°</h3>	Size	Part Number	List Price	<h3>F 90°</h3>	Size	Part Number	List Price
	1-1/2"	150D90	\$23.30		1-1/2"	150F90	\$13.56
	2"	200D90	\$28.91		2"	200F90	\$14.54
Female Coupler x Female NPT				Male Adapter x Male NPT			

G

Line Strainers

	Size	Part Number	List Price	Size	Part Number	List Price	FEATURES <ul style="list-style-type: none"> Precision molded construction. Corrosion resistant. Lightweight. Easy grip end cap. 304 Stainless steel screen (polypropylene screens optional) EPDM gasket. Heavy duty end cap threads.
	3/4"	LS075-20	\$42.42	1-1/2"	LS150-30	\$93.35	
	3/4"	LS075-40	\$42.42	1-1/2"	LS150-50	\$93.35	
	3/4"	LS075-80	\$42.42	1-1/2"	LS150-80	\$93.35	
	1"	LS100-20	\$42.42	2"	LS200-06	\$93.35	
	1"	LS100-40	\$42.42	2"	LS200-12	\$93.35	
	1"	LS100-80	\$42.42	2"	LS200-20	\$93.35	
	1-1/2"	LS150-06	\$93.35	2"	LS200-30	\$93.35	
	1-1/2"	LS150-12	\$93.35	2"	LS200-50	\$93.35	
	1-1/2"	LS150-20	\$93.35	2"	LS200-80	\$93.35	

Note: Last two digits of part number is the mesh of the screen.

Replacement Mesh LS

	Size	Part Number	List Price	Size	Part Number	List Price
	1/2" to 3/4"	LS720	\$25.11	1-1/2" to 2"	LS230	\$51.40
	1/2" to 3/4"	LS740	\$25.11	1-1/2" to 2"	LS250	\$51.40
	1/2" to 3/4"	LS780	\$25.11	1-1/2" to 2"	LS280	\$51.40
	1" to 1-1/4"	LS120	\$25.11	3" X 3"	*LS304	\$159.53
	1" to 1-1/4"	LS140	\$25.11	3" X 3"	*LS308	\$159.53
	1" to 1-1/4"	LS180	\$25.11	3" X 3"	*LS312	\$159.53
	1-1/2" to 2"	LS206	\$51.40	3" X 3"	*LS320	\$159.53
	1-1/2" to 2"	LS212	\$51.40	3" X 3"	*LS350	\$159.53
	1-1/2" to 2"	LS220	\$51.40			

304 Stainless Steel

*LS300 Reinforced Stainless Screen

STANDARD MESHES AND DATA (For General Reference Only)

MESH	MICRONS	WIRE DIAMETER	OPENING	%OPEN AREA	MESH	MICRONS	WIRE DIAMETER	OPENING	%OPEN AREA
4 Mesh	4760	.047	.203	65.9	20 Mesh	841	.016	.034	46.2
6 Mesh	3360	.035	.132	62.7	30 Mesh	595	.012	.021	40.8
8 Mesh	2380	.028	.097	60.2	50 Mesh	297	.009	.011	30.3
10 Mesh	2000	.025	.075	56.3	80 Mesh	177	.0055	.007	31.4
12 Mesh	1680	.023	.060	51.8	100 Mesh	149	.0045	.005	30.3
16 Mesh	1190	.018	.044	50.7					

3" Polypropylene "Y" Strainers

Part Number	Size	Description	List Price
LSM300-04	3" X 3"	Strainer - 4 Mesh Screen	\$622.15
LSM300-08	3" X 3"	Strainer - 8 Mesh Screen	\$622.15
LSM300-12	3" X 3"	Strainer - 12 Mesh Screen	\$622.15
LSM300-20	3" X 3"	Strainer - 20 Mesh Screen	\$622.15
LSM300-50	3" X 3"	Strainer - 50 Mesh Screen	\$622.15



FEATURES

- Lightweight.
- High Volume.
- Constructed of glass filled polypropylene.
- Stainless steel "T" handle clamp.
- 1/2" drain plug in bottom of cap.
- Reinforced stainless steel screen.

WARNING: 3" Polypropylene "Y" Strainer to be used on suction side or non-pressure side in all applications.



Poly "T" Strainers



Size	Part Number	List Price	Size	Part Number	List Price
3/4"	LST075-16	\$44.85	1"	LST100-80	\$44.85
3/4"	LST075-30	\$44.85	1"	LST100-100	\$44.85
3/4"	LST075-50	\$44.85	1-1/2"	LST150-16	\$89.36
3/4"	LST075-80	\$44.85	1-1/2"	LST150-30	\$89.36
3/4"	LST075-100	\$44.85	1-1/2"	LST150-50	\$89.36
1"	LST100-16	\$44.85	1-1/2"	LST150-80	\$89.36
1"	LST100-30	\$44.85	1-1/2"	LST150-100	\$89.36
1"	LST100-50	\$44.85			

Replacement Mesh LST

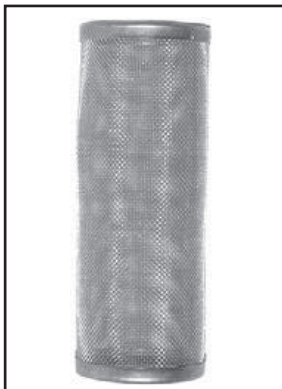

Size	Part Number	List Price	Size	Part Number	List Price
3/4" & 1"	LST116 *	\$21.17	2"	LST204SS **	\$68.46
3/4" & 1"	LST130 *	\$21.17	2"	LST206SS **	\$68.46
3/4" & 1"	LST150 *	\$21.17	2"	LST208SS **	\$68.46
3/4" & 1"	LST180 *	\$21.17	2"	LST210SS **	\$68.46
3/4" & 1"	LST1100 *	\$21.17	2"	LST216SS **	\$68.46
1-1/4" & 1-1/2"	LST1516 *	\$34.76	2"	LST230SS **	\$68.46
1-1/4" & 1-1/2"	LST1530 *	\$34.76	2"	LST250SS **	\$68.46
1-1/4" & 1-1/2"	LST1550 *	\$34.76	2"	LST280SS **	\$68.46
1-1/4" & 1-1/2"	LST1580 *	\$34.76	2"	LST2100SS **	\$68.46
1-1/4" & 1-1/2"	LST15100 *	\$34.76			

* 304 Stainless Steel

** 316 Stainless Steel

Polypropylene Pipe Fittings

Pipe Nipple



Part Number	Size or Description	List Price
NIP038-SH	3/8" X Short Poly Pipe Nipple	\$1.44
NIP050-SH	1/2" X Short Poly Pipe Nipple	\$1.60
NIP050-3	1/2" X 3" Poly Pipe Nipple	\$3.05
NIP075-SH	3/4" X Short Poly Pipe Nipple	\$1.66
NIP075-4	3/4" X 4" Poly Pipe Nipple	\$3.19
NIP075-6	3/4" X 6" Poly Pipe Nipple	\$3.74
NIP100-SH	1" X Short Poly Pipe Nipple	\$2.37
NIP100-4	1" X 4" Poly Pipe Nipple	\$3.36
NIP100-6	1" X 6" Poly Pipe Nipple	\$4.20
NIP125-SH	1-1/4" X Short Poly Pipe Nipple	\$2.37
NIP125-4	1-1/4" X 4" Poly Pipe Nipple	\$4.20
NIP125-6	1-1/4" X 6" Poly Pipe Nipple	\$4.77
NIP150-SH	1-1/2" X Short Poly Pipe Nipple	\$4.37
NIP150-3	1-1/2" X 3" Poly Pipe Nipple	\$5.38
NIP150-4	1-1/2" X 4" Poly Pipe Nipple	\$8.97
NIP150-5	1-1/2" X 5" Poly Pipe Nipple	\$10.03
NIP150-6	1-1/2" X 6" Poly Pipe Nipple	\$10.55
NIP200-SH	2" X 2" Short Poly Pipe Nipple	\$4.95
NIP200-4	2" X 4" Poly Pipe Nipple	\$10.43
NIP200-6	2" X 6" Poly Pipe Nipple	\$12.17
NIP300-SH	3" X Short Poly Pipe Nipple	\$15.51
NIP300-4	3" X 4" Poly Pipe Nipple	\$23.30
NIP300-6	3" X 6" Poly Pipe Nipple	\$30.04
NIP400-SH	4" X Short Poly Pipe Nipple	\$24.14

Poly Reducer Nipples

Part Number	Size	List Price
RN050-038	1/2" x 3/8"	\$2.42
RN075-050	3/4" x 1/2"	\$2.60
RN100-050	1" x 1/2"	\$3.33
RN100-075	1" x 3/4"	\$3.05
RN125-075	1-1/4" x 3/4"	\$3.51
RN125-100	1-1/4" x 1"	\$3.19
RN150-100	1-1/2" x 1"	\$3.78
RN150-125	1-1/2" x 1-1/4"	\$3.36
RN200-125	2" x 1-1/4"	\$4.61
RN200-150	2" x 1-1/2"	\$3.75
RN300-200	3" x 2"	\$15.44

Poly Reducer Bushings



Part Number	Size or Description	List Price
RB038-025	3/8"NPTx1/4"FPT Poly Pipe Reducer	\$3.19
RB050-025	1/2"NPTx1/4"FPT Poly Pipe Reducer	\$3.19
RB050-038	1/2"NPTx3/8"FPT Poly Pipe Reducer	\$3.19
RB075-018	3/4"NPTx1/8"FPT Poly Pipe Reducer	\$3.19
RB075-025	3/4"NPT x1/4"FPT Poly Pipe Reducer	\$3.19
RB075-038	3/4"NPTx3/8"FPT Poly Pipe Reducer	\$3.19
RB075-050	3/4"NPTx1/2"FPT Poly Pipe Reducer	\$3.19
RB100-018	1"NPTx1/8"FPT Poly Pipe Reducer	\$3.36
RB100-025	1"NPTx1/4"FPT Poly Pipe Reducer	\$3.36
RB100-050	1"NPTx1/2"FPT Poly Pipe Reducer	\$3.36
RB100-075	1"NPTx3/4"FPT Poly Pipe Reducer	\$3.36
RB125-075	1-1/4"NPTx3/4"FPT Poly Pipe Reducer	\$3.36
RB125-100	1-1/4"NPTx1"FPT Poly Pipe Reducer	\$3.36
RB150-075	1-1/2"NPTx3/4"FPT Poly Pipe Reducer	\$4.46
RB150-100	1-1/2"NPTx1"FPT Poly Pipe Reducer	\$4.46
RB150-125	1-1/2"NPTx1-1/4"FPT Poly Pipe Reducer	\$4.46
RB200-075	2"NPTx3/4"FPT Poly Pipe Reducer	\$4.88
RB200-100	2"NPTx1"FPT Poly Pipe Reducer	\$4.88
RB200-125	2"NPTx1-1/4"FPT Poly Pipe Reducer	\$4.88
RB200-150	2"NPTx1-1/2"FPT Poly Pipe Reducer	\$4.88
RB300-150	3"NPTx1-1/2"FPT Poly Pipe Reducer	\$20.27
RB300-200	3"NPTx2"FPT Poly Pipe Reducer	\$20.27
RB400-300	4"NPTx3"FPT Poly Pipe Reducer	\$31.43

Hose Mender

Part Number	Size	List Price
HM050	1/2"	\$1.52
HM075	3/4"	\$1.67
HM100	1"	\$2.04
HM125	1-1/4"	\$2.30
HM150	1-1/2"	\$4.08
HM200	2"	\$5.13
HM300	3"	\$16.01

Pipe Cross

Part Number	Size	List Price
CR075	3/4" Poly Pipe Cross	\$21.63
CR100	1" Poly Pipe Cross	\$21.63
CR125	1-1/4" Poly Pipe Cross	\$32.26
CR150	1-1/2" Poly Pipe Cross	\$32.26
CR200	2" Poly Pipe Cross	\$39.48

G

Polypropylene Pipe Fittings

Pipe Tees

	Part Number	Size	List Price
	TEE038	3/8"	\$4.69
	TEE050	1/2"	\$4.95
	TEE075	3/4"	\$5.30
	TEE100	1"	\$8.82
	TEE125	1-1/4"	\$8.82
	TEE150	1-1/2"	\$12.64
	TEE200	2"	\$15.77
	TEE300	3"	\$75.14

Street Elbow 90°

	Part Number	Size	List Price
	SL038-90	3/8" Poly St. Elbow 90	\$4.46
	SL050-90	1/2" Poly St. Elbow 90	\$4.46
	SL075-90	3/4" Poly St. Elbow 90	\$4.77
	SL100-90	1" Poly St. Elbow 90	\$5.64
	SL125-90	1-1/4" Poly St. Elbow 90	\$7.05
	SL150-90	1-1/2" Poly St. Elbow 90	\$10.99
	SL200-90	2" Poly St. Elbow 90	\$13.04
	SL300-90	3" Poly St. Elbow 90	\$66.40

Pipe Couplings

	Part Number	Size	List Price
	CPLG038	3/8" Poly Pipe Coupling	\$4.88
	CPLG050	1/2" Poly Pipe Coupling	\$4.88
	CPLG075	3/4" Poly Pipe Coupling	\$4.88
	CPLG100	1" Poly Pipe Coupling	\$5.54
	CPLG125	1-1/4" Poly Pipe Coupling	\$7.47
	CPLG150	1-1/2" Poly Pipe Coupling	\$12.40
	CPLG200	2" Poly Pipe Coupling	\$14.17
	CPLG300	3" Poly Pipe Coupling	\$40.07

Street Elbow 45°

	Part Number	Size	List Price
	SL075-45	3/4" Poly St. Elbow 45	\$7.67
	SL100-45	1" Poly St. Elbow 45	\$11.24
	SL125-45	1-1/4" Poly St. Elbow 45	\$13.93
	SL150-45	1-1/2" Poly St. Elbow 45	\$14.86
	SL200-45	2" Poly St. Elbow 45	\$17.62
	SL300-45	3" Poly St. Elbow 45	\$72.94

Pipe Plug

	Part Number	Size	List Price
	PLUG050	1/2" Poly Pipe Plug	\$3.36
	PLUG075	3/4" Poly Pipe Plug	\$3.36
	PLUG100	1" Poly Pipe Plug	\$3.36
	PLUG125	1-1/4" Poly Pipe Plug	\$3.36
	PLUG150	1-1/2" Poly Pipe Plug	\$5.38
	PLUG200	2" Poly Pipe Plug	\$5.38
PLUG300	3" Poly Pipe Plug	\$21.22	

Pipe Elbow 90°

	Part Number	Size	List Price
	EL038-90	3/8" Poly St. Elbow 90	\$4.71
	EL050-90	1/2" Poly St. Elbow 90	\$4.26
	EL075-90	3/4" Poly St. Elbow 90	\$4.61
	EL100-90	1" Poly St. Elbow 90	\$5.44
	EL125-90	1-1/4" Poly St. Elbow 90	\$6.80
	EL150-90	1-1/2" Poly St. Elbow 90	\$10.66
	EL200-90	2" Poly St. Elbow 90	\$12.66
EL300-90	3" Poly St. Elbow 90	\$64.38	

Pipe Elbow 45°

	Part Number	Size	List Price
	EL100-45	1" Poly Pipe Elbow 45°	\$14.66

Pipe Cap

	Part Number	Size	List Price
	CAP050	1/2" Poly Pipe Cap	\$6.53
	CAP075	3/4" Poly Pipe Cap	\$6.53
	CAP100	1" Poly Pipe Cap	\$6.53
	CAP125	1-1/4" Poly Pipe Cap	\$7.34
	CAP150	1-1/2" Poly Pipe Cap	\$9.24
	CAP200	2" Poly Pipe Cap	\$10.73
CAP300	3" Poly Pipe Cap	\$38.40	

Hose Barbs

	Size	Part Number	List Price	Size	Part Number	List Price	Size	Part Number	List Price
	3/8"	HB038	\$1.46	3/4" x 1"	HB075-100	\$2.00	1-1/2" x 1-1/4"	HB150-125	\$3.65
	3/8" x 1/2"	HBO38-050	\$1.46	1" x 3/4"	HB100-075	\$2.00	1-1/2"	HB150	\$4.08
	1/2" x 3/8"	HB050-038	\$1.46	1"	HB100	\$2.00	1-1/2" x 2"	HB150-200	\$6.27
	1/2"	HB050	\$1.46	1" x 1-1/4"	HB100-125	\$2.44	2" x 1-1/2"	HB200-150	\$6.27
	1/2" x 3/4"	HB050-075	\$1.61	1-1/4" X 3/4"	HB125-075	\$2.44	2"	HB200	\$5.00
	3/4" x 3/8"	HB075-038	\$1.61	1-1/4" X 1"	HB125-100	\$2.44	3"	HB300	\$16.12
	3/4" x 1/2"	HB075-050	\$1.61	1-1/4"	HB125	\$2.44	4"	HB400	\$33.78
	3/4" x 5/8"	HB075-058	\$2.00	1-1/4" x 1-1/2"	HB125-150	\$4.66			
	3/4"	HB075	\$1.61	1-1/2" x 1"	HB150-100	\$3.65			

FEATURES:

- Precision molded in polypropylene.
- Hose Barbs are designed specifically to fit properly when inserted into hose.
- Polypropylene is glass filled for rugged strength and durability.
- Male Thread x Hose Shank.





Push-on Air Hose

This oil resistant hose is excellent for use with air tools, mild chemicals and various petroleum products. Special braid angle for quick secure push-on coupling retention.

Temperature range: -40° F to 212° F

Construction:

Tube: Black Nitrile

Reinforcement: Black Neoprene

Cover: One Textile Braid

Safety Factor : 3:1

Part Number	ID	OD	Working Pressure psi	Bend Radius	Weight Per Foot	Standard Length (Feet)	List Price Per Foot
PH025	1/4"	0.500"	300max	3.0	9	300'	\$0.91
PH038	3/8"	0.625"	300max	3.0	12	300'	\$1.13
PH050	1/2"	0.750"	300max	5.0	15	300'	\$1.49

Used With Thermoplastic Or Rubber Push-on Style Hose

Ease of assembly - push on design - brass

Excellent vibration characteristics

H

Hose x Male NPT

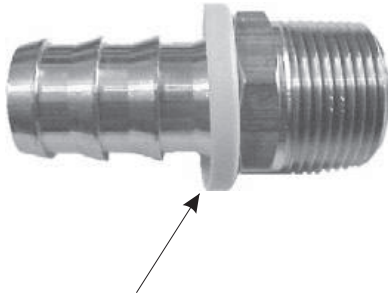
 <p>Brass</p> <p>Plastic protection cap for hose.</p>	Part Number	Hose I.D.	Pipe Thread	List Price
	301-42	1/4"	1/8"	\$0.89
301-44	1/4"	1/4"	\$1.34	
301-46	1/4"	3/8"	\$1.66	
301-52	5/16"	1/8"	\$0.94	
301-62	3/8"	1/8"	\$1.23	
301-64	3/8"	1/4"	\$1.51	
301-66	3/8"	3/8"	\$1.66	
301-86	1/2"	3/8"	\$2.00	
301-88	1/2"	1/2"	\$2.81	
301-812	1/2"	3/4"	\$4.28	
301-108	5/8"	1/2"	\$3.42	
301-1212	3/4"	3/4"	\$4.87	
301-1616	1"	1"	\$5.60	

Hose x FPT

 <p>Brass</p>	Part Number	Hose I.D.	Pipe Thread	List Price
	3099-42	1/4"	1/8"	\$0.94
3099-44	1/4"	1/4"	\$1.34	
3099-52	5/16"	1/8"	\$1.42	
3099-62	3/8"	1/8"	\$1.42	
3099-64	3/8"	1/4"	\$1.49	
3099-66	3/8"	3/8"	\$1.85	
3099-86	1/2"	3/8"	\$2.70	
3099-88	1/2"	1/2"	\$3.21	
3099-812	1/2"	3/4"	\$4.06	
3099-108	5/8"	1/2"	\$4.81	
3099-1212	3/4"	3/4"	\$5.00	
3099-1616	1"	1"	\$5.47	



Hose x 45° SAE Male

 <p>Brass</p>	Part Number	Hose I.D.	SAE Thread	List Price
	302-44	1/4"	1/4"	\$0.91
	302-45	1/4"	5/16"	\$1.15
	302-46	1/4"	3/8"	\$1.72
	302-66	3/8"	3/8"	\$1.72
	302-88	1/2"	1/2"	\$2.60
	302-1212	3/4"	3/4"	\$3.02

Hose x Female 45° Flare, Swivel SAE

 <p>Brass</p>	Part Number	Hose I.D.	SAE Thread	List Price
	307-46	1/4"	3/8"	\$1.94
	307-66	3/8"	3/8"	\$2.02
	307-1212	3/4"	3/4"	\$5.92

Hose x Inverted Flare Male, Swivel

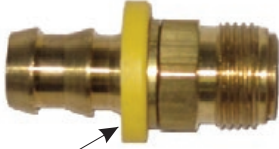
 <p>Brass</p> <p>Plastic protection cap for hose.</p>	Part Number	Hose I.D.	Thread	List Price
	305-43	1/4"	3/16"	\$1.57
	305-44	1/4"	1/4"	\$1.13
	305-45	1/4"	5/16"	\$1.28
	305-55	5/16"	5/16"	\$1.89
	305-66	3/8"	3/8"	\$2.02
	305-88	1/2"	1/2"	\$3.36
	305-1010	5/8"	5/8"	\$4.92

Hose x Inverted Flare

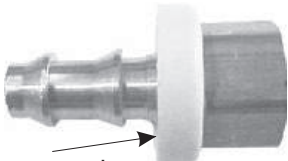
 <p>Brass</p> <p>Plastic protection cap for hose.</p>	Part Number	Hose I.D.	Thread	List Price
	306-43	1/4"	3/16"	\$0.81
	306-44	1/4"	1/4"	\$0.87
	306-45	1/4"	5/16"	\$0.92
	306-55	5/16"	5/16"	\$1.58
	306-66	3/8"	3/8"	\$1.58
	306-88	1/2"	1/2"	\$2.25
	306-1010	5/8"	5/8"	\$2.83

Hose x JIC Female, Swivel 37°

 <p>Brass</p>	Part Number	Hose I.D.	Thread	List Price
	308-44	1/4"	1/4"	\$1.32
	308-46	1/4"	3/8"	\$1.75
	308-66	3/8"	3/8"	\$1.85
	308-88	1/2"	1/2"	\$2.83
	308-1212	3/4"	3/4"	\$5.74
	308-1616	1"	1"	\$6.00





GRIP-ON & GARDEN HOSE FITTINGS

Hose x JIC Male 37°

 <p>Brass</p>	Part Number	Hose I.D.	Thread JIC Flare	List Price
	310-44	1/4"	1/4"	\$1.13
	310-45	1/4"	5/16"	\$1.72
	310-66	3/8"	3/8"	\$2.00
	310-88	1/2"	1/2"	\$3.00
	310-1212	3/4"	3/4"	\$4.81
	310-1616	1"	1"	\$6.00

Hose x Hose Splicer

Used With Thermoplastic Or Rubber Push-on Style Hose

 <p>Brass</p> <p>Plastic protection cap for hose.</p>	Part Number	Hose I.D.		List Price
	304-44	1/4"		\$1.15
	304-55	5/16"		\$1.21
	304-66	3/8"		\$1.51
	304-88	1/2"		\$2.08
	304-1010	5/8"		\$3.55
	304-1212	3/4"		\$4.17
	304-1616	3/4"		\$6.04

Hose Barb x Hose Barb - Garden Hose Fittings GHT

 <p>Brass</p>	Part Number	Garden Thread	Hose I.D.	List Price
	202GSHS-88	3/4"	1/2"	\$6.89
	202GSHS-1010	3/4"	5/8"	\$7.02
	202GSHS-1212	3/4"	3/4"	\$7.58

Brass Shank Couplings

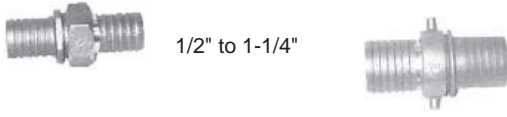
			 <p>1/2" to 1-1/4"</p> <p>1-1/2" to 3"</p>	
Complete Set			Short Shank	
Size	Part Number	List Price	Part Number	List Price
1/2" x 3/4" IPT	BLS050075	\$9.81	BSS050075	\$7.51
1/2" x 3/4" GHT	BLS050075GHT	\$9.34	BSS050075GHT	\$7.51
5/8" X 3/4" IPT	BLS058075	\$10.66	BSS058075	\$7.74
5/8" x 3/4" GHT	BLS058075GHT	\$11.23	BSS058075GHT	\$7.74
3/4" x 3/4" IPT	BLS075	\$13.17	BSS075	\$8.26
3/4" x 3/4" GHT	BLS075GHT	\$11.68	BSS075GHT	\$8.26
1" x 1" IPT	BLS100	\$14.89	BSS100	\$12.60
<p>Price of Male: 1/2 of Complete Set Price of Female: 2/3 of Complete Set</p>				



GARDEN HOSE FITTINGS

Female GHT x Female Pipe

 Brass	Part Number	Garden Thread	Pipe Thread	List Price
	5A-12D	3/4"	1/2"	\$3.47
	5A-12E	3/4"	3/4"	\$3.89

Female GHT x Female Pipe, Swivel

 Brass	Part Number	Garden Thread	Pipe Thread	List Price
	5AS-12D	3/4"	1/2"	\$2.64
	5AS-12E	3/4"	3/4"	\$3.40

Male GHT x Female Pipe

 Brass	Part Number	Garden Thread	Pipe Thread	List Price
	18A-12D	3/4"	1/2"	\$2.51
	18A-12E	3/4"	3/4"	\$2.68

Male Pipe x Male GHT

 Brass	Part Number	Garden Thread	Pipe Thread	List Price
	19A-12C	3/4"	3/8"	\$2.45
	19A-12D	3/4"	1/2"	\$1.26
	19AF-12DE	3/4"	3/4"	\$3.28

Male GHT x Male GHT

 Brass	Part Number	Garden Thread	Pipe Thread	List Price
	23A-12	3/4" X 3/4"		\$2.55

Female Hose Cap GHT

 Brass	Part Number	Garden Thread	Pipe Thread	List Price
	GHN5H	3/4"		\$1.36



NST to GHT

 Brass 19130 24155	Part Number	Discription	List Price
	1913009	1-1/2" FNST X 3/4" MGHT	\$7.87
	1913037	2-1/2" FNST X 3/4" MGHT	\$14.25
	2415517	3/4" FGHT X 3/4" MNPT	\$2.94
	2415518	3/4" FGHT X 1" MNPT	\$6.42
	2415520	1" FNPT X 3/4" MGHT	\$5.04





Nozzles

 <p>Zinc Alloy Body w/TPR PGN075</p>	 <p>ULC Approved Shut-off - 10403 Plastic</p>	Part Number	Description	List Price
		PGN075	3/4" GHT Pistol Grip Nozzle	\$8.40
		1040310	3/4" GHT Green	\$20.91

Premium Gardenflex



Part Number	Description	List Price
GFH058050	5/8" x 50' Coupled with GHT Threads	\$64.06
GFH058100	5/8" x 100' Coupled with GHT Threads	\$124.15

Kink resistant under pressure and abrasion resistant.

Temperature range: -40° F to +150° F
Construction: Premium Hybrid Polymer

Rubber Garden Hose



Part Number	Description	List Price
RGH058050	5/8" X 50' Rubber Garden Hose	\$48.00
RGH058100	5/8" x 100' Rubber Garden Hose	\$94.32
RGH075050	3/4" x 50' Rubber Garden Hose	\$72.45
RGH075100	3/4" x 100' Rubber Garden Hose	\$139.40
RGH100050	1" x 50' Rubber Garden Hose	\$89.34

Octagon Rubber Garden Hose



Part Number	Description	List Price
ORGH058050	5/8" X 50' Rubber Garden Hose	\$46.87



BRASS HOSE FITTINGS

Brass Hose Mender

	Part Number	Hose I. D.	List Price	Part Number	Hose I. D.	List Price
	HM-2	1/8"	\$0.53	HM-6	3/8"	\$1.25
	HM-3	3/16"	\$0.64	HM-8	1/2"	\$1.38
	HM-4	1/4"	\$0.70	HM-10	5/8"	\$1.96
	HM-5	5/16"	\$0.96	HM-12	3/4"	\$2.38

Brass Hose Fittings

Male Hose End NPT Threads				Female Hose Swivel Or Ridged NPS Threads					
Part Number	Hose I. D.	Thread Size	List Price	Part Number Swivel	List Price	Part Number Ridged	List Price	Hose I. D.	Thread Size
201A-2A	1/8"	1/8"	\$0.64	209AS-2A	\$1.17	209A-2A	\$0.72	1/8"	1/8"
201A-3A	3/16"	1/8"	\$0.66	209AS-3A	\$1.17	209A-3A	\$0.83	3/16"	1/8"
201A-3B	3/16"	1/4"	\$1.06	209AS-3B	\$1.25	209A-3B	\$1.09	3/16"	1/4"
201A-4A	1/4"	1/8"	\$0.77	--	--	--	--	--	--
201A-4B	1/4"	1/4"	\$1.09	209AS-4B	\$0.83	209A-4B	\$0.92	1/4"	1/4"
201A-4C	1/4"	3/8"	\$1.38	--	--	--	--	--	--
201A-5A	5/16"	1/8"	\$0.79	--	--	--	--	--	--
201A-5B	5/16"	1/4"	\$1.09	209AS-5B	\$1.02	209A-5B	\$1.09	5/16"	1/4"
201A-5C	5/16"	3/8"	\$1.47	--	--	--	--	--	--
201A-6A	3/8"	1/8"	\$0.87	--	--	--	--	--	--
201A-6B	3/8"	1/4"	\$1.26	209AS-6B	\$0.94	209A-6B	\$0.92	3/8"	1/4"
201A-6C	3/8"	3/8"	\$1.53	209AS-6C	\$1.45	209A-6C	\$1.21	3/8"	3/8"
201A-6D	3/8"	1/2"	\$2.53	--	--	--	--	--	--
201A-6E	3/8"	3/4"	\$3.60	--	--	--	--	--	--
201A-8B	1/2"	1/4"	\$1.26	--	--	--	--	--	--
201A-8C	1/2"	3/8"	\$1.68	209AS-8C	\$1.30	209A-8C	\$1.42	1/2"	3/8"
201A-8D	1/2"	1/2"	\$2.47	209AS-8D	\$1.81	209A-8D	\$1.77	1/2"	1/2"
201A-8E	1/2"	3/4"	\$3.75	--	--	--	--	--	--
201A-10C	5/8"	3/8"	\$1.79	--	--	--	--	--	--
201A-10D	5/8"	1/2"	\$2.72	--	--	--	--	--	--
201A-10E	5/8"	3/4"	\$3.87	--	--	--	--	--	--
201A-12D	3/4"	1/2"	\$2.91	--	--	--	--	--	--
201A-12E	3/4"	3/4"	\$4.17	209AS-12E	\$2.55	209A-12E	\$3.11	3/4"	3/4"
201A-16E	1"	3/4"	\$5.19	--	--	--	--	--	--





BRASS FERRULES

Brass Ferrules for medium weight air hose

Sold in pkg. quantity only.

	Part Number	I. D.	Length	Hole	Metal Thickness	Cross Reference	Quantity Per pkg.	List Price Per Ferrule
	B-478-L	.478"	.687"	.328"	.025"	4750	50	\$0.24
	B-525-SP10	.525"	.500"	.406"	.020"		50	\$0.22
	B-560-SP1	.560"	1.00"	.437"	.025"	7325	50	\$0.39
	B-593-L	.593"	1.00"	.437"	.025"	7326	50	\$0.39
	B-625-SP4	.625"	1.00"	.437"	.025"	7327	50	\$0.42
	B-656-L	.656"	1.00"	.437"	.025"	7328	50	\$0.45
	B-690-L	.690"	1.00"	.500"	.025"	7329	50	\$0.49
	B-718-SP1	.718"	1.00"	.500"	.025"	7330	50	\$0.49
	B-750-SP3	.750"	1.00"	.625"	.025"	7331	50	\$0.52
	B-781-SP2	.781"	1.00"	.625"	.025"	7332	50	\$0.52
	B-812-L	.812"	1.00"	.625"	.025"	7333	50	\$0.58
	B-825-SP2	.825"	.546"	.562"	.020"	AA	50	\$0.33
	B-850-L	.850"	.968"	.687"	.025"		50	\$0.62
B-937-L	.937"	.875"	.750"	.025"	7242	25	\$0.59	

H

Brass Ferrules for light weight air hose

Sold in pkg. quantity only.

	Part Number	I. D.	Length	Hole	Metal Thickness	Cross Reference	Quantity Per pkg.	List Price Per Ferrule
	B-380-S	.380"	.500"	.265"	.020"	622	50	\$0.18
	B-410-S	.410"	.500"	.265"	.020"	620	50	\$0.16
	B-450-SP1-S	.450"	.562"	.343"	.020"	769	50	\$0.20
	B-500-SP2	.500"	.500"	.343"	.020"	624	50	\$0.20
	B-525-SP6	.525"	.470"	.360"	.020"	625	50	\$0.21
	B-560-SP2	.560"	.750"	.375"	.020"	3588	50	\$0.28
	B-575-SP1	.575"	.484"	.468"	.020"	KK	50	\$0.24
	B-600-SP2	.600"	.500"	.500"	.020"	JJ	50	\$0.25
	B-625-SP3	.625"	.500"	.500"	.020"	II	50	\$0.26
	B-650-SP3	.650"	.500"	.500"	.020"	HH	50	\$0.25
	B-725-SP3	.725"	.530"	.500"	.020"	EE	50	\$0.30
	B-750-SP5	.750"	.531"	.500"	.020"	DD	50	\$0.30

Brass Ferrules for medium weight water hose

Sold in pkg. quantity only.

	Part Number	I. D.	Length	Hole	Metal Thickness	Cross Reference	Quantity Per pkg.	List Price Per Ferrule
	B-875-SP1	.875"	.843"	.687"	.025"	7244A	50	\$0.54
	B-900-SP2	.900"	.875"	.687"	.025"	5029A	50	\$0.58
	B-975-SP2	.975"	.843"	.687"	.025"	5028A	50	\$0.62
	B-1025-SP1	1.025"	.843"	.687"	.025"	7114A	50	\$0.64
	B-1050-SP1	1.050"	.843"	.687"	.025"	7145A	50	\$0.65
	B-1100-SP2	1.100"	.843"	.812"	.025"	5027A	50	\$0.76
	B-1175-SP1	1.175"	.875"	.875"	.025"	7088A	25	\$0.73
	B-1225-SP1	1.225"	.968"	.875"	.025"		25	\$0.92
	B-1275-SP1	1.275"	.968"	.875"	.025"		25	\$0.92
	B-1425-SP1	1.425"	.875"	1.062"	.025"		25	\$1.22
	B-1500-S	1.500"	.875"	1.125"	.025"		25	\$1.01
	B-1550-S	1.550"	.812"	1.125"	.025"		25	\$1.10



CRIMPING TOOLS

The following models of hose crimpers provide production capability and a big tool crimping advantages at just a fraction of the cost of other tools offering comparable results.

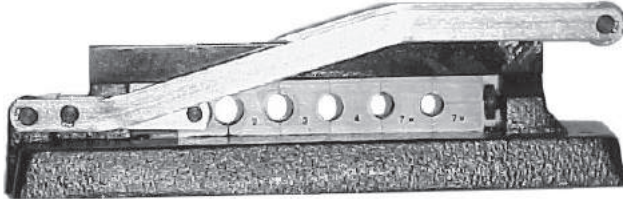

3041

Part Number	Size	List Price
3041	Crimp Tool comes with dies 3041-1 thru 3041-5	\$223.58
3043	Crimp Tool comes with dies 3041-1 thru 3041-4 and 3048A	\$223.58

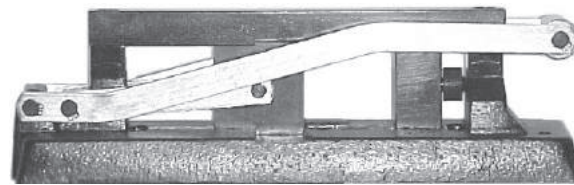

3042

Part Number	Size	List Price
3042	Crimp Tool capable of 1/2" to 1" ID 7/8" to 1-1/2" OD Sold without crimping dies.	\$261.32

Arrangement of dies in tool #3041 is as follows:
No mark with hole, 2, 3, 4, 5, no mark no hole.

Arrangement of dies in tool #3043 is as follows:
No mark with hole, 2, 3, 4, 7W, 7W-with one flat side.

Dies For Ferrule Crimp Tool 3041

	Part Number	Mark	Size	List Price
	3041-1	no mark, 2	5/8"	\$36.79
	3041-2	2, 3	37/64"	\$36.79
	3041-3	3, 4	17/32"	\$36.79
	3041-4	4, 5	31/64"	\$36.79
	3041-5	5, no mark	11/16"	\$36.79
	3048A	7W, 7W	7/16"	\$36.79
	3049A	8W, 8W	3/4"	\$36.79
	3050A	9W, 9W	13/16"	\$36.79
	3051A	10W, 10W	3/8"	\$36.79

Dies For Ferrule Crimp Tool 3042

	Part Number	Mark	Size	List Price
	3042-1	1	11/16"	\$45.25
	3042-2	2	23/32"	\$45.25
	3042-3	3	3/4"	\$45.25
	3042-4	4	25/32"	\$45.25
	3042-5	5	13/16"	\$45.25
	3042-6	6	27/32"	\$45.25
	3042-7	7	7/8"	\$45.25
	3042-8	8	29/32"	\$45.25
	3042-9	9	15/16"	\$45.25
	3042-10	10	31/32"	\$45.25
	3042-11	11	1"	\$45.25
	3042-12	12	1-1/32"	\$45.25
	3042-13	13	1-1/16"	\$45.25
	3042-14	14	1-1/8"	\$45.25
	3042-15	15	1-3/16"	\$45.25
	3042-16	16	1-1/4"	\$45.25
	3042-17	17	1-5/16"	\$45.25
	3042-18	18	1-3/8"	\$45.25
	3042-19	19	1-7/16"	\$45.25
	3042-20	20	1-1/2"	\$45.25





For Air Only

Brass Sockets 1/4" Body

Semi-Automatic Pull to Connect Sleeve

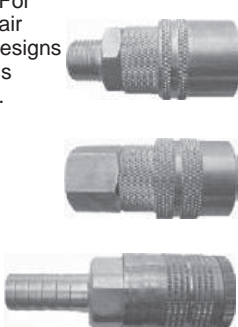
<p>Couplers shut-off when disconnected. Works with MIL-4109C SYSTEM For use with compressed air easy pull-to connect designs provides instantaneous connection of air lines. Seal material: NBR</p> <p>Temperature Range: -0° F to 176° F</p> <p>Working Pressure: 0 psi to 300 psi</p> <p>4 Ball Design</p>	<p>10 PER BOX</p> 	Part Number	Body Size	End Description	Overall length	Overall Diameter	Box Quantity	List Price
		AM-02AM	1/4"	1/4" Male NPT	2.03"	.98"	10	\$5.25
		AM-03AM	1/4"	3/8" Male NPT	2.03"	.98"	10	\$5.51
		AM-04AM	1/4"	1/2" Male NPT	2.07"	.98"	10	\$6.25
		AM-02AF	1/4"	1/4" Female NPT	1.97"	.98"	10	\$5.25
		AM-03AF	1/4"	3/8" Female NPT	1.97"	.98"	10	\$5.75
		AM-04AF	1/4"	1/2" Female NPT	2.13"	.98"	10	\$6.51
		AM-02AH	1/4"	1/4" Shank	2.3"	.98"	10	\$5.25
		AM-03AH	1/4"	3/8" Shank	2.7"	.98"	10	\$5.51
		AM-04AH	1/4"	1/2" Shank	2.7"	.98"	10	\$6.00

Steel Plugs 1/4" Body

Works with AM or AMA Sockets

<p>Works with MIL-4109C.</p> <p>40 PER BOX</p>  <p>Yellow Zinc Plated</p>	Part Number	Body Size	End Description	Overall length	Overall Diameter	Box Quantity	List Price
	AN-02AMS	1/4"	1/4" Male NPT	1.65"	0.46"	40	\$0.60
	AN-03AMS	1/4"	3/8" Male NPT	1.69"	0.46"	40	\$0.98
	AN-04AMS	1/4"	1/2" Male NPT	1.73"	0.46"	40	\$1.75
	AN-02AFS	1/4"	1/4" Female NPT	1.38"	0.46"	40	\$0.66
	AN-03AFS	1/4"	3/8" Female NPT	1.5"	0.46"	40	\$1.06
	AN-04AFS	1/4"	1/2" Female NPT	1.54"	0.46"	40	\$2.00
	AN-02AHS	1/4"	1/4" Shank	1.89"	0.46"	40	\$0.72
	AN-03AHS	1/4"	3/8" Shank	2.28"	0.46"	40	\$1.00
	AN-04AHS	1/4"	1/2" Shank	2.28"	0.46"	40	\$1.42

Brass Plugs 1/4" Body

Works with AM or AMA Sockets

<p>Works with MIL-4109C.</p> <p>40 PER BOX</p>  <p>Brass</p>	Part Number	Body Size	End Description	Overall length	Overall Diameter	Box Quantity	List Price
	AN-02AM	1/4"	1/4" Male NPT	1.65"	0.46"	40	\$1.33
	AN-03AM	1/4"	3/8" Male NPT	1.69"	0.46"	40	\$1.91
	AN-04AM	1/4"	1/2" Male NPT	1.73"	0.46"	40	\$2.91
	AN-02AF	1/4"	1/4" Female NPT	1.38"	0.46"	40	\$1.33
	AN-03AF	1/4"	3/8" Female NPT	1.5"	0.46"	40	\$2.26
	AN-04AF	1/4"	1/2" Female NPT	1.54"	0.46"	40	\$3.26
	AN-02AH	1/4"	1/4" Shank	1.89"	0.46"	40	\$1.21
	AN-03AH	1/4"	3/8" Shank	2.28"	0.46"	40	\$1.51
	AN-04AH	1/4"	1/2" Shank	2.28"	0.46"	40	\$1.91



For Air Only

Brass Sockets 1/4" Body

Works with AN plugs

Automatic

<p>Couplers shut-off when disconnected. Works with MIL-4109C SYSTEM AUTOMATIC TYPE For use with compressed air easy pull-to connect designs provides instantaneous connection of air lines. Seal material: NBR Temperature Range: -0° F to 176° F Working Pressure: 0 psi to 300 psi</p> <p>10 PER BOX</p> 	Part Number	Body Size	End Description	Overall length	Overall Diameter	Box Quantity	List Price
	AMA-02AM	1/4"	1/4" Male NPT	2.05"	.98"	10	\$6.25
	AMA-03AM	1/4"	3/8" Male NPT	2.09"	.98"	10	\$6.60
	AMA-02AF	1/4"	1/4" Female NPT	1.97"	.98"	10	\$7.25
	AMA-03AF	1/4"	3/8" Female NPT	1.97"	.98"	10	\$6.51
	AMA-02AH	1/4"	1/4" Shank	2.32"	.98"	10	\$6.91
AMA-03AH	1/4"	3/8" Shank	2.48"	.98"	10	\$7.75	

Brass Sockets 1/4" Body

Works with AO plugs

Automatic

<p>A quick-connective coupling designed to be completely interchangeable with RECTUS 22, ARO 210, Parker50, CEJN 310 SERIES. For use with compressed air. Easy, automatic push-to connect designs provide instantaneous connections of air lines. Seal material: NBR Temperature Range: -0°F to 176°F Working Pressure: 0 psi to 300 psi</p> <p>10 PER BOX</p> 	Part Number	Body Size	End Description	Overall length	Overall Diameter	Box Quantity	List Price/ea
	AO-02AM	1/4"	1/4" Male NPTF	2.05"	.98"	10	\$5.51
	AO-03AM	1/4"	3/8" Male NPT	2.09"	.98"	10	\$5.75
	AO-02AF	1/4"	1/4" Female NPT	1.97"	.98"	10	\$5.75
	AO-03AF	1/4"	3/8" Female NPT	1.97"	.98"	10	\$6.00
	AO-02AH	1/4"	1/4" Shank	2.32"	.98"	10	\$5.51
AO-03AH	1/4"	3/8" Shank	2.48"	.98"	10	\$5.75	

Steel Plugs 1/4" Body

Works with AO Sockets

<p>For use with compressed air. When use with automatic push-to connect designs it provide easy instantaneous connections of air lines.</p> <p>10 PER BOX</p> 	Part Number	Body Size	End Description	Overall length	Overall Diameter	Box Quantity	List Price/ea
	AO-02PMS	1/4"	1/4" Male NPT	2.05"	.98"	10	\$0.60
	AO-03PMS	1/4"	3/8" Male NPT	2.09"	.98"	10	\$0.98
	AO-02PFS	1/4"	1/4" Female NPT	1.97"	.98"	10	\$0.66
	AO-03PFS	1/4"	3/8" Female NPT	1.97"	.98"	10	\$1.06
	AO-02PHS	1/4"	1/4" Shank	2.32"	.98"	10	\$0.72
AO-03PHS	1/4"	3/8" Shank	2.48"	.98"	10	\$1.00	



PNEUMATIC PRODUCTS

Pressure Washer Couplings

Water use only

Brass Sockets

(Straight thru quick connect fittings)

 <p>Often used on pressure washers. * 1/4" Rated pressure 5200 psi * 3/8" Rated pressure 2700 psi * Temperature range -40° to 250°F * Standard seal Buna-n (Nitrile)</p>	Part Number	Body Size	End Description	Overall length	Overall Diameter	Exposed length	Hex Size	List Price
	2STF2-B	1/4"	1/4" Female NPT	1.48"	0.93"	--	0.82"	\$3.75
	3STF3-B	3/8"	3/8" Female NPT	1.59"	1.20"	--	0.94"	\$5.57
	2STM2-B	1/4"	1/4" Male NPT	1.73"	0.93"	--	0.82"	\$4.26
	3STM3-B	3/8"	3/8" Male NPT	1.76"	1.30"	--	0.94"	\$6.02

These couplers and plugs have no internal valves so there will be maximum flow.

Steel Plugs

 <p>Often used on pressure washers. * 1/4" Rated pressure 5200 psi * 3/8" Rated pressure 2700 psi</p> <p>Yellow Zinc Plated</p>	Part Number	Body Size	End Description	Overall length	Overall Diameter	Exposed length	Hex Size	List Price
	ST2F2-S	1/4"	1/4" Female NPT	1.45"	0.75"	0.67"	0.67"	\$0.72
	ST3F3-S	3/8"	3/8" Female NPT	1.64"	0.95"	0.96"	0.86"	\$1.11
	ST2M2-S	1/4"	1/4" Male NPT	1.56"	0.61"	0.81"	0.54"	\$0.68
	ST3M3-S	3/8"	3/8" Male NPT	1.70"	0.68"	0.86"	0.67"	\$1.02

These couplers and plugs have no internal valves so there will be maximum flow.

Pressure Washer Couplings

	Part Number	Body Size	End Description	List Price
	PWC 38	3/8"	3/8" Female X 22mm X 14mm Swivel	\$10.51

Pressure Washer Hose Assemblies



Tested hydrostatically to 3500 psi. There is a bend retractor on each end with male solid by male swivel.

Hose ID	Part Number	Pressure Washer Hose Assemblies	List Price
3/8"	PW30003850CL	3/8" X 50' Pressure Washer Coupled w/ Male X Male	\$78.45
3/8"	PW300038100CL	3/8" X 100' Pressure Washer Coupled w/ Male X Male	\$136.42
1/2"	PW30005050CL	1/2" X 50' Pressure Washer Coupled w/ Male X Male	\$122.72
1/2"	PW300050100CL	1/2" X 100' Pressure Washer Coupled w/ Male X Male	\$226.30
1/2"	PW30003850BLCL	3/8" X 50' Blue Pressure Washer	\$88.04



PNEUMATIC PRODUCTS

Nylon Recoil Hose (Yellow)



Part Number	ID	OD	Swivel & Rigid NPT Thread	Length in Feet				Color	List Price
N2512	.236"	.314"	1/4"	12	-	-	-	Yellow	\$10.75
N2525	.236"	.314"	1/4"	25	-	-	-	Yellow	\$16.00
N2550	.236"	.314"	1/4"	50	-	-	-	Yellow	\$25.51
N3812	.275"	.394"	3/8"	12	-	-	-	Yellow	\$16.75
N3825	.275"	.394"	3/8"	25	-	-	-	Yellow	\$26.74
N3850	.275"	.394"	3/8"	50	-	-	-	Yellow	\$45.96

Temperature range: -20° F to +180° F, WP: 200psi

Polyurethane Recoil Hose (Blue)



Part Number	ID	OD	NPT Thread	Length in Feet				Color	List Price
P2510	.255"	.375"	1/4"	10	-	-	-	Blue	\$13.00
P2520	.255"	.375"	1/4"	20	-	-	-	Blue	\$18.51
P2530	.255"	.495"	1/4"	30	-	-	-	Blue	\$24.23
P3810	.375"	.495"	3/8"	10	-	-	-	Blue	\$15.00
P382510	.375"	.495"	3/8"	10	-	-	-	Blue	\$14.75
P3820	.375"	.495"	3/8"	20	-	-	-	Blue	\$22.51
P382520	.375"	.495"	3/8"	20	-	-	-	Blue	\$22.25
P3830	.375"	.495"	3/8"	30	-	-	-	Blue	\$29.23
P382530	.375"	.495"	3/8"	30	-	-	-	Blue	\$28.98

Temperature range: -40° F to +100° F, WP: 120psi

Blow Guns

Blow Gun (1/4")  SAFETY Part Number AR-905 List Price \$6.51	Rubber Tip Blow Gun Part Number AR-905-C List Price \$6.75
	Booster Tip Blow Gun Part Number AR-905-A List Price \$7.11

Industrial Air/Water Hose Assembly

Red  Brass Couplings Both Ends 1/4" NPT	Hose ID	Part Number	Working Pressure psi	Burst Pressure psi	Length	List Price
	3/8"	PA2525	200	600	25'	\$17.15
	3/8"	PA2550	200	600	50'	\$27.51

Construction:
 Cover EPDM / SBR mix compound
 Tube NBR / SBR Mix compound rubber

The working pressure ratings are based on ambient temperature of 70° F and will vary inversely with temperature changes.

PVC Air Tool Hose Assembly

 Yellow Brass Couplings Both Ends 1/4" NPT Flexible, lightweight handling with strain relief sleeves.	Hose ID	Part Number	Working Pressure PSI	Burst Pressure PSI	Length	List Price
	1/4"	33903	300	900	25'	\$13.00
	1/4"	33904	300	900	50'	\$22.49
	3/8"	33913	300	900	25'	\$15.75
	3/8"	33914	300	900	50'	\$27.98



HYDRAULIC HOSE COUPLINGS

Hydraulic Quick-connect

Applications

This series couplings are used in a wide range of hydraulic applications including construction equipment, manufacturing machinery, and in-plant systems. They can be found anywhere the fluid transfer lines need to be connected and disconnected for operation or maintenance of equipment. Rugged construction makes these couplings a good choice for mobile applications including dump trucks, snow plows, refuse hauling, mining, asphalt paving, truck trailer connections and many more. In-plant machinery applications include hydraulic fluid, chemicals and gas lines for paper mills, steel production, and many varieties of plant maintenance and production equipment.



Sockets (Carbon Steel)

<p>They are designed to meet ISO 7241-A standard.</p> <p>Interchangeable with: Hansen HA15000 Series Parker 6600 Series Faster Anv Series Stucchi Bir Series Safeway S565 Series</p> 	Part Number	Body Size	End Description	Overall length	Overall Diameter	Hex Size	List Price
	CI-02SB	1/4"	1/4" Female NPT	47mm 1.85"	25mm .98"	19mm	\$10.09
	CI-03SB	3/8"	3/8" Female NPT	57mm 2.24"	31mm 1.22"	22mm	\$11.66
	CI-04SB	1/2"	1/2" Female NPT	66mm 2.59"	38mm 1.49"	27mm	\$12.08
	CI-06SB	3/4"	3/4" Female NPT	82.5mm 3.24"	54mm 2.12"	34mm	\$21.42
	CI-08SB	1"	1" Female NPT	117mm 4.60"	70mm 2.75"	41mm	\$32.68

J

Plugs (Carbon Steel)

<p>They are designed to meet ISO 7241-A standard.</p> <p>Interchangeable with: Hansen HA15000 Series Parker 6600 Series Faster Anv Series Stucchi Bir Series Safeway S565 Series</p> 	Part Number	Body Size	End Description	Overall length	Plug Length	Hex Size	List Price
	CI-02PB	1/4"	1/4" Female NPT	35mm 1.37"	20mm 0.78"	19mm	\$4.32
	CI-03PB	3/8"	3/8" Female NPT	39mm 1.53"	26mm 1.02"	22mm	\$5.00
	CI-04PB	1/2"	1/2" Female NPT	44mm 1.73"	32mm 1.25"	27mm	\$5.09
	CI-06PB	3/4"	3/4" Female NPT	55mm 2.16"	37mm 1.45"	34mm	\$9.32
	CI-08PB	1"	1" Female NPT	75mm 2.95"	46mm 1.81"	41mm	\$14.21

<p>Material:</p> <p>Coupler Body: Steel Valve: Steel Springs: Spring Steel Locking O-Ring: Spring Steel Balls: GCr 15 Seals: Buna-N(Nitrile) Surface treatment: Zinc plating and Cr 3+ passivation</p> 	Body Size	Working Pressure	Working Temperature	
	1/4"	4600 psi	-13°F to +250°F -25°C to +120°C	
	3/8"	4000 psi	-13°F to +250°F -25°C to +120°C	
	1/2"	3600 psi	-13°F to +250°F -25°C to +120°C	
	3/4"	3600 psi	-13°F to +250°F -25°C to +120°C	
1"	3000 psi	-13°F to +250°F -25°C to +120°C		



HYDRAULIC HOSE COUPLINGS

Male Pipe NPTF Rigid

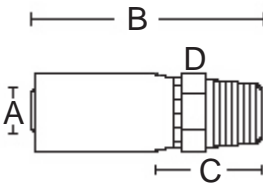
	Part Number	Hose ID	Thread	A	B	C	D	E	F	List Price
	MP-04-02	1/4"	1/8" X 27"	0.25"	2.134"	0.879"	5/8"	-	-	-
MP-04-04	1/4"	1/4" x 18"	0.25"	2.315"	1.070"	11/16"	-	-	-	\$2.21
MP-04-06	3/8"	3/8" x 18"	0.25"	2.409"	1.164"	3/4"	-	-	-	\$2.49
MP-06-04	3/8"	1/4" x 18"	0.375"	2.650"	1.154"	3/4"	-	-	-	\$2.60
MP-06-06	3/8"	3/8" x 18"	0.375"	2.650"	1.154"	3/4"	-	-	-	\$2.64
MP-06-08	3/8"	1/2" x 14"	0.375"	2.910"	1.406"	15/16"	-	-	-	\$3.08
MP-08-06	1/2"	3/8" x 18"	0.50"	2.840"	1.154"	7/8"	-	-	-	\$3.30
MP-08-08	1/2"	1/2" x 14"	0.50"	3.100"	1.406"	7/8"	-	-	-	\$3.36
MP-12-12	3/4"	3/4" x 14"	0.75"	3.290"	1.406"	1-1/8"	-	-	-	\$4.81
MP-16-16	1"	1" x 11-1/2"	1.00"	3.930"	1.656"	1-3/8"	-	-	-	\$7.85

Male Pipe NPTF Rigid Short Shell

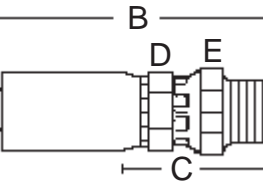
	Part Number	Hose ID	Thread	A	B	C	D	E	F	List Price
	10143-04-02	1/4"	1/8" x 27"	-	-	-	-	-	-	-
10143-04-04	1/4"	1/4" x 18"	-	-	-	-	-	-	-	\$1.57
10143-06-06	3/8"	3/8" x 18"	-	-	-	-	-	-	-	\$1.98
10143-08-08	1/2"	1/2" x 14"	-	-	-	-	-	-	-	\$2.60
10143-12-12	3/4"	3/4" x 14"	-	-	-	-	-	-	-	\$4.51
10143-16-16	1"	1" x 11-1/2"	-	-	-	-	-	-	-	\$7.85

Male Pipe NPTF Swivel

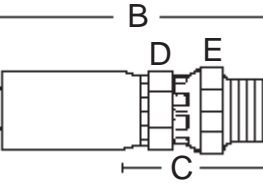
	Part Number	Hose ID	Thread	A	B	C	D	E	F	List Price
	MPX-04-04	1/4"	1/4" x 18"	0.25"	2.851"	1.596"	5/8"	11/16"	-	-
MPX-06-06	3/8"	3/8" x 18"	0.375"	3.19"	1.69"	3/4"	3/4"	-	-	\$3.32
MPX-06-08	3/8"	1/2" x 14"	0.375"	3.38"	1.88"	3/4"	7/8"	-	-	\$3.42
MPX-08-08	1/2"	1/2" x 14"	0.50"	3.641"	1.943"	7/8"	15/16"	-	-	\$4.26
MPX-12-12	3/4"	3/4" x 14"	0.75"	3.885"	2.005"	1-1/8"	1-1/8"	-	-	\$6.30
MPX-16-16	1"	1" x 11-1/2"	1.00"	4.593"	2.313"	1-3/8"	1-1/2"	-	-	\$9.79

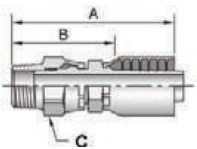

Male Pipe NPTF Swivel Short Shell

	Part Number	Hose ID	Thread	A	B	C	D	E	F	List Price
	11343-06-06	3/8"	3/8" x 18"	3.08"	2.05"	-	-	-	-	-

Male Pipe Swivel - 90°

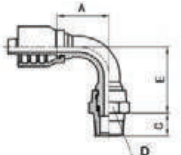
	Part Number	Hose ID	Thread	A	B	C	D	E	F	List Price
	MPX90-08-12	1/2"	3/4" x 14"	1.77"	1.417"	0.763"	-	3.6"	-	-



HYDRAULIC HOSE COUPLINGS

Female Pipe NPSM Swivel

Part Number	Hose ID	Thread	Dimensions						List Price
			A	B	C	D	E	F	
FPX-04-04	1/4"	1/4" x 14"	0.25"	2.349"	1.094"	5/8"	3/4"	-	\$2.55
FPX-06-06	3/8"	3/8" x 18"	0.375"	2.688"	1.188"	7/8"	7/8"	-	\$3.09
FPX-08-08	1/2"	1/2" x 14"	0.5"	3.028"	1.338"	1"	1"	-	\$3.72

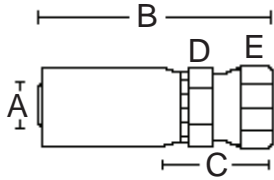

Female Pipe NPSM Swivel Short Shell

Part Number	Hose ID	Thread	Dimensions						List Price
			A	B	C	D	E	F	
10843-08-08	1/2"	1/2" x 14"	2.11"	1.36"	3/4"	3/4"	-	-	\$2.89

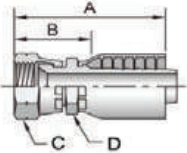

J

Male JIC 37 Rigid

Part Number	Hose ID	Thread	Dimensions						List Price
			A	B	C	D	E	F	
MJ-04-04	1/4"	7/16" x 20"	0.25"	2.3"	1.05"	5/8"	-	-	\$2.30
MJ-04-05	1/4"	1/2" x 20"	0.25"	2.305"	1.05"	5/8"	-	-	\$2.47
MJ-06-06	3/8"	9/16" x 18"	0.25"	2.405"	1.15"	3/4"	-	-	\$2.75
MJ-06-08	3/8"	3/4" x 16"	0.375"	2.751"	1.251"	13/16"	-	-	\$3.06
MJ-08-08	1/2"	3/4" x 16"	0.5"	2.939"	1.251"	7/8"	-	-	\$3.28
MJ-08-10	1/2"	7/8" x 14"	0.5"	3.102"	1.414"	15/16"	-	-	\$3.57
MJ-12-12	3/4"	1-1/16" x 12"	0.75"	3.395"	1.52"	1-1/8"	-	-	\$4.55
MJ-16-16	1"	1-5/16" x 12"	1"	3.902"	1.627"	1-3/8"	-	-	\$7.87

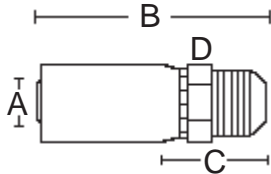

Male Boss O-Ring Rigid

Part Number	Hose ID	Thread	Dimensions						List Price
			A	B	C	D	E	F	
MB-04-04	1/4"	7/16" x 20"	0.25"	2.13"	0.86"	5/8"	-	-	\$1.57
MB-04-06	1/4"	9/16" x 18"	0.25"	2.146"	0.891"	11/16"	-	-	\$1.74
MB-06-06	3/8"	9/16" x 18"	0.375"	2.48"	0.985"	3/4"	-	-	\$2.00
MB-06-08	3/8"	3/4" x 16"	0.375"	2.532"	1.032"	7/8"	-	-	\$2.21
MB-08-08	1/2"	3/4" x 16"	0.5"	2.782"	1.094"	7/8"	-	-	\$2.62
MB-08-10	1/2"	7/8" x 14"	0.5"	2.844"	1.156"	1-1/16"	-	-	\$2.98

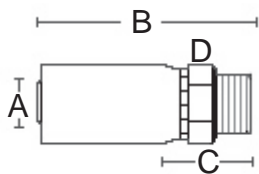



HYDRAULIC HOSE COUPLINGS

Female JIC 37 Swivel

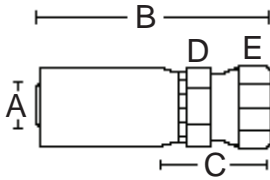
	Part Number	Hose ID	Thread	A	B	C	D	E	F	List Price
	FJX-04-04	1/4"	7/16" x 20"	0.25"	2.505"	1.25"	5/8"	9/16"	-	\$2.55
FJX-04-05	1/4"	1/2" x 20"	0.25"	2.505"	1.25"	5/8"	3/4"	-	\$2.55	
FJX-04-06	1/4"	9/16" x 18"	0.25"	2.505"	1.25"	5/8"	11/16"	-	\$3.17	
FJX-06-06	3/8"	9/16" x 18"	0.375"	2.844"	1.344"	3/4"	11/16"	-	\$3.17	
FJX-06-08	3/8"	3/4" x 16"	0.375"	2.844"	1.344"	3/4"	7/8"	-	\$3.77	
FJX-08-08	1/2"	3/4" x 16"	0.5"	3.188"	1.5"	7/8"	7/8"	-	\$3.87	
FJX-08-10	1/2"	7/8" x 14"	0.5"	3.188"	1.5"	7/8"	1-1/16"	-	\$3.85	
FJX-12-12	3/4"	1-1/16" x 12"	0.75"	3.474"	1.594"	1-1/8"	1-1/4"	-	\$5.70	
FJX-12-16	3/4"	1-5/16" - 12"	0.75"	3.536"	1.656"	1-3/8"	1-1/2"	-	\$6.28	
FJX-16-16	1"	1-5/16" - 12"	1"	3.996"	1.716"	1-3/8"	1-1/2"	-	\$9.60	

Female JIC 37 Swivel Short Shell

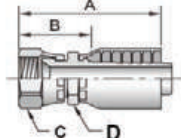
	Part Number	Hose ID	Thread	A	B	C	D	E	F	List Price
	10643-06-06	3/8"	9/16" x 18"	2.29"	1.26"	-	11/16"	-	-	\$2.19
10643-08-08	1/2"	3/4" x 16"	2.63"	1.37"	-	13/16"	-	-	\$2.89	
10643-08-10	1/2"	7/8" x 14"	2.82"	1.38"	-	15/16"	-	-	\$3.25	

Female JIC 37 Swivel 90 Elbow

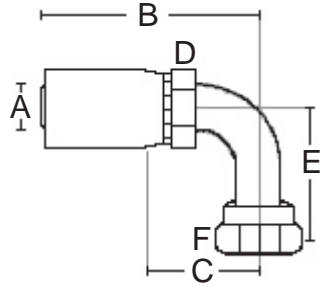
	Part Number	Hose ID	Thread	A	B	C	D	E	F	List Price
	FJX90-04-04	1/4"	7/16" x 20"	0.25"	2.31"	1.295"	5/8"	0.88"	9/16"	\$2.53
FJX90-04-06	1/4"	9/16" x 18"	0.25"	2.4"	1.35"	5/8"	1.13"	11/16"	\$2.57	
FJX90-06-06	3/8"	9/16" x 18"	0.375"	2.705"	1.376"	3/4"	1.12"	11/16"	\$3.32	
FJX90-06-08	3/8"	3/4" x 16"	0.375"	2.75"	1.496"	3/4"	1.38"	7/8"	\$3.55	
FJX90-08-08	1/2"	3/4" x 16"	0.5"	3.043"	1.312"	7/8"	1.39"	7/8"	\$4.38	
FJX90-08-10	1/2"	7/8" x 14"	0.5"	3.375"	1.437"	7/8"	1.59"	1"	\$4.77	
FJX90-12-12	3/4"	1-1/16" x 12"	0.75"	4.022"	2.063"	1-1/8"	2.28"	1-1/4"	\$7.32	
FJX90-16-16	1"	1-5/16" x 12"	1.000"	3.401"	2.063"	1-3/8"	2.51"	1-1/2"	\$13.85	

Female JIC 37 Swivel 45 Elbow

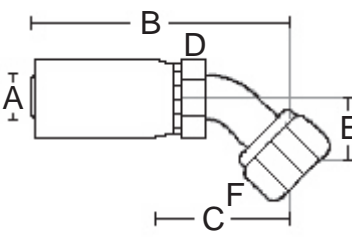
	Part Number	Hose ID	Thread	A	B	C	D	E	F	List Price
	FJX45-04-04	1/4"	7/16" x 20"	0.25"	2.58"	1.403"	5/8"	0.45"	9/16"	\$2.53
FJX45-04-06	1/4"	9/16" x 18"	0.25"	2.645"	1.375"	5/8"	1.5"	11/16"	\$2.70	
FJX45-06-06	3/8"	9/16" x 18"	0.375"	2.967"	1.253"	3/4"	0.59"	11/16"	\$2.70	
FJX45-06-08	3/8"	3/4" x 16"	0.375"	3.158"	1.658"	3/4"	0.713"	7/8"	\$2.94	
FJX45-08-08	1/2"	3/4" x 16"	0.5"	3.411"	1.658"	7/8"	0.635"	7/8"	\$4.28	
FJX45-08-10	1/2"	7/8" x 14"	0.5"	3.523"	1.773"	7/8"	0.839"	1"	\$4.64	
FJX45-12-12	3/4"	1-1/16" x 12"	0.75"	4.329"	2.449"	1-1/8"	1.118"	1-1/4"	\$7.17	
FJX45-16-16	1"	1-5/16" x 12"	1"	4.971"	2.639"	1-1/8"	1.059"	1-1/2"	\$13.45	





HYDRAULIC HOSE COUPLINGS

Male Boss O-Ring Swivel

Part Number	Hose ID	Thread	A	B	C	D	E	F	List Price
MBX-04-04	1/4"	7/16" x 20"	0.25"	2.935"	1.68"	5/8"	0.69"	-	\$1.81
MBX-06-06	3/8"	9/16" x 18"	0.375"	3.12"	1.62"	3/4"	0.75"	-	\$2.36
MBX-06-08	3/8"	3/4" x 16"	0.375"	3.108"	1.608"	3/4"	0.088"	-	\$2.60
MBX-08-08	1/2"	3/4" x 16"	0.5"	3.637"	1.939"	7/8"	0.94"	-	\$3.30
MBX-08-10	1/2"	7/8" x 14"	0.5"	3.487"	1.789"	7/8"	1"	-	\$3.70

Male Boss O-Ring Swivel 90

Part Number	Hose ID	Thread	A	B	C	D	E	F	List Price
MBX90-04-04	1/4"	7/16" x 20"	0.25"	2.312"	0.819"	11/16"	1.59"	-	\$2.47
MBX90-06-06	3/8"	9/16" x 18"	0.375"	2.75"	0.725"	3/4"	1.74"	-	\$4.04
MBX90-08-06	1/2"	3/4" x 16"	0.37"	2.97"	1.25"	3/4"	1.65"	-	\$4.74
MBX90-08-08	1/2"	3/4" x 16"	0.5"	3"	0.781"	15/16"	1.92"	-	\$4.94

J

Female JIC 90 Long

Part Number	Hose ID	Thread	A	B	C	D	E	F	List Price
FJX90L-04-04	1/4"	7/16" x 20"	0.25"	2.328"	1.063"	0.625"	5/8"	1.8"	\$2.58
FJX90L-06-06	3/8"	9/16" x 18"	0.375"	2.625"	1.188"	0.750"	3/4"	2.18"	\$3.38
FJX90L-08-08	1/2"	3/4" x 16"	0.5"	2.938"	1.312"	0.875"	7/8"	2.43"	\$4.47
FJX90L-12-12	3/4"	1-1/16" x 12"	0.75"	2.875"	2.021"	2.063"	1-1/8"	4.33"	\$7.43

45 SAE Male Rigid

Part Number	Hose ID	Thread	A	B	C	D	E	F	List Price
MS-06-06	3/8"	5/8" x 18"	0.375"	2.724"	1.224"	3/4"	-	-	\$2.00

45 SAE Female Swivel

Part Number	Hose ID	Thread	A	B	C	D	E	F	List Price
FSX-06-06	3/8"	5/8" x 18"	0.375"	2.844"	1.344"	3/4"	13/16"	-	\$2.19



HYDRAULIC HOSE COUPLINGS

NPTF Solid Male Stem (100R12 Skive Type Coupling Includes Ferrule)

Part Number	Hose ID	Thread	A Bore	B Stem Hex	C Length	D Cut-off	List Price
RI2MP-12-12	3/4"	3/4" X 1/4	0.56"	1.17"	3.36"	1.53"	\$6.18
RI2MP-16-16	1"	1" X 11-1/2	0.80"	1.40"	3.96"	1.78"	\$10.91
RI2MP-20-20	1-1/4"	1-1/4" X 11-1/2	1.04"	1.81"	4.49"	1.97"	\$13.74
RI2MP-24-24	1-1/2"	1-1/2" X 11-1/2	1.27"	1.96"	4.63"	2.01"	\$20.18
RI2MP-32-32	2"	2" X 11-1/2	1.67"	2.55"	4.95"	2.12"	\$31.52

30° Cone inside.

Ferrules (For R12 Fittings)

Sold in sets only

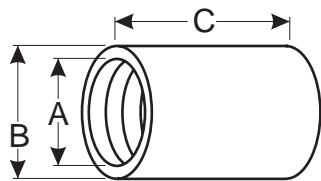

Part Number	A ID	B OD	C Length
R12F-12	1.16"	1.54"	2.00"
R12F-16	1.40"	1.81"	2.39"
R12F-20	1.90"	2.36"	2.79"
R12F-24	2.10"	2.55"	2.91"
R12F-32	2.57"	3.06"	3.07"

NPTF Solid Male Stem (100R13 Skive Type Coupling Includes Ferrule)

Part Number	Hose ID	Thread	A Bore	B Stem Hex	C Length	D Cut-off	List Price
RI3MP-12-12	3/4"	3/4" X 1/4	0.56"	1.17"	3.36"	1.53"	\$6.91
RI3MP-16-16	1"	1" X 11-1/2	0.80"	1.40"	3.96"	1.78"	\$7.31
RI3MP-20-20	1-1/4"	1-1/4" X 11-1/2	1.04"	1.81"	4.49"	1.97"	\$14.98
RI3MP-24-24	1-1/2"	1-1/2" X 11-1/2	1.29"	1.95"	4.80"	2.00"	\$22.29
RI3MP-32-32	2"	2" X 11-1/2	1.67"	2.55"	5.16"	2.15"	\$34.57

30° Cone inside.

Ferrules (For R13 Fittings)

Sold in sets only

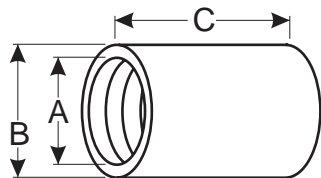

Part Number	A ID	B OD	C Length
R13F-12	1.19"	1.58"	2.00"
R13F-16	1.46"	1.85"	2.40"
R13F-20	1.91"	2.37"	2.79"
R13F-24	2.20"	2.70"	3.06"
R13F-32	2.75"	3.26"	3.35"





HYDRAULIC HOSE COUPLINGS

Hydraulic Pipe Swivel Adapters

Swivel Pipe Union

Male NPTF Pipe
X Female NPSM Swivel

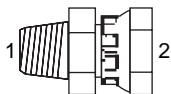

Part Number	T1 (NPTF)	T2 (NPSM)	List Price Steel
1404-02-02	1/8"	1/8"	\$1.17
1404-02-04	1/8"	1/4"	\$1.17
1404-04-02	1/4"	1/8"	\$1.19
1404-04-04	1/4"	1/4"	\$1.25
1404-04-06	1/4"	3/8"	\$1.55
1404-06-04	3/8"	1/4"	\$1.70
1404-06-06	3/8"	3/8"	\$1.58
1404-06-08	3/8"	1/2"	\$2.06
1404-08-04	1/2"	1/4"	\$2.11
1404-08-06	1/2"	3/8"	\$2.42
1404-08-08	1/2"	1/2"	\$2.11
1404-08-12	1/2"	3/4"	\$3.25
1404-12-08	3/4"	1/2"	\$3.28
1404-12-12	3/4"	3/4"	\$2.87
1404-12-16	3/4"	1"	\$3.62
1404-16-16	1"	1"	\$4.94
1404-16-20	1"	1 1/4"	\$7.51
1404-20-16	1 1/4"	1"	\$6.00
1404-20-20	1 1/4"	1 1/4"	\$7.06
1404-20-24	1 1/4"	1 1/2"	\$9.00
1404-24-20	1 1/2"	1 1/4"	\$9.17
1404-24-24	1 1/2"	1 1/2"	\$16.98
1404-32-32	2"	2"	\$27.55

Swivel Pipe Union

Female Pipe X
Female Pipe Swivel

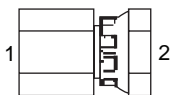

Part Number	T1 (NPTF)	T2 (NPSM)	List Price Steel
1405-02-02	1/8"	1/8"	\$1.09
1405-04-04	1/4"	1/4"	\$1.26
1405-04-06	1/4"	3/8"	\$1.70
1405-06-04	3/8"	1/4"	\$1.70
1405-06-06	3/8"	3/8"	\$1.58
1405-06-08	3/8"	1/2"	\$1.91
1405-08-06	1/2"	3/8"	\$2.28
1405-08-08	1/2"	1/2"	\$2.11
1405-08-12	1/2"	3/4"	\$3.28
1405-12-08	3/4"	1/2"	\$2.64
1405-12-12	3/4"	3/4"	\$2.96
1405-12-16	3/4"	1"	\$5.28
1405-16-12	1-11"	3/4"	\$5.21
1405-16-16	1-11"	1"	\$5.28
1405-20-20	1 1/4"	1 1/4"	\$7.79
1405-24-24	1 1/2"	1 1/2"	\$10.30
1405-32-32	2"	2"	\$18.94



HYDRAULIC HOSE COUPLINGS

Hydraulic Pipe Swivel Adapters

Swivel Pipe Union

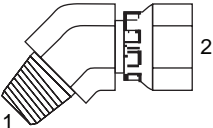
45 Male Pipe X Female Pipe Swivel	Part Number	T1 (NPTF)	T2 (NPSM)	List Price Steel
		1503-02-02	1/8"	1/8"
1503-02-04		1/8"	1/4"	\$1.62
1503-04-04		1/4"	1/4"	\$1.45
1503-04-06		1/4"	3/8"	\$1.83
1503-06-04		3/8"	1/4"	\$1.94
1503-06-06		3/8"	3/8"	\$2.08
1503-06-08		3/8"	1/2"	\$3.28
1503-08-04		1/2"	1/4"	\$2.11
1503-08-06		1/2"	3/8"	\$2.34
1503-08-08		1/2"	1/2"	\$2.98
1503-08-12		1/2"	3/4"	\$4.00
1503-12-06		3/4"	3/8"	\$3.43
1503-12-08		3/4"	1/2"	\$4.94
1503-12-12		3/4"	3/4"	\$3.87
1503-12-16		3/4"	1"	\$9.94
1503-16-12		1"	3/4"	\$8.89
1503-16-16		1"	2"	\$7.09
1503-16-20		1"	1-1/4"	\$9.34
1503-20-16		1-1/4"	1"	\$10.30
1503-20-20		1-1/4"	1-1/4"	\$12.28
1503-24-24	1-1/2"	1-1/2"	\$19.30	
1503-32-32	2"	2"	\$27.36	

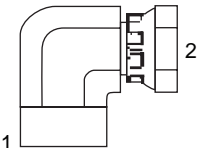

Swivel Pipe Union

90 Female Pipe X Female Pipe Swivel	Part Number	T1 (NPTF)	T2 (NPSM)	List Price Steel
		1502-02-02	1/8"	1/8"
1502-04-02		1/4"	1/8"	\$1.98
1502-04-04		1/4"	1/4"	\$1.91
1502-04-06		1/4"	3/8"	\$2.36
1502-06-04		3/8"	1/4"	\$2.36
1502-06-06		3/8"	3/8"	\$2.26
1502-06-08		3/8"	1/2"	\$3.25
1502-08-06		1/2"	3/8"	\$3.32
1502-08-08		1/2"	1/2"	\$3.09
1502-12-08		3/4"	1/2"	\$4.34
1502-12-12		3/4"	3/4"	\$4.72
1502-16-12		1"	3/4"	\$8.11
1502-16-16		1"	1"	\$8.68
1502-20-16		1 1/4"	1"	\$14.70
1502-20-20		1 1/4"	1 1/4"	\$15.34
1502-24-24		1 1/2"	1 1/2"	\$21.17
1502-32-32		2"	2"	\$33.60



HYDRAULIC HOSE COUPLINGS

Hydraulic Pipe Swivel Adapters

Swivel Pipe Union

90 Male Pipe
X Female Pipe Swivel

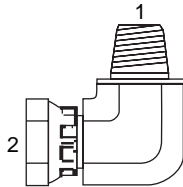

J

Part Number	T1 (NPTF)	T2 (NPSM)	List Price Steel
1501-02-02	1/8"	1/8"	\$1.38
1501-02-04	1/8"	1/4"	\$1.68
1501-04-02	1/4"	1/8"	\$1.58
1501-04-04	1/4"	1/4"	\$1.72
1501-04-06	1/4"	3/8"	\$2.04
1501-06-04	3/8"	1/4"	\$1.94
1501-06-06	3/8"	3/8"	\$2.92
1501-06-08	3/8"	1/2"	\$2.55
1501-08-04	1/2"	1/4"	\$2.32
1501-08-06	1/2"	3/8"	\$2.32
1501-08-08	1/2"	1/2"	\$2.68
1501-08-12	1/2"	3/4"	\$3.53
1501-12-06	3/4"	3/8"	\$3.83
1501-12-08	3/4"	1/2"	\$4.02
1501-12-12	3/4"	3/4"	\$4.40
1501-12-16	3/4"	1"	\$8.19
1501-16-12	1"	3/4"	\$7.66
1501-16-16	1"	1"	\$14.89
1501-16-20	1"	1"	\$13.43
1501-20-12	1-1/4"	3/4"	\$17.49
1501-20-16	1-1/4"	1"	\$14.60
1501-20-20	1-1/4"	1-1/4"	\$14.60
1501-20-24	1-1/4"	1-1/2"	\$21.62
1501-24-20	1-1/2"	1-1/4"	\$21.62
1501-24-24	1-1/2"	1-1/2"	\$23.13
1501-32-32	2"	2"	\$34.26



HYDRAULIC HOSE COUPLINGS

Hydraulic 37 Flare To Pipe Adapters

37 Flare To Pipe

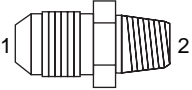
	Part Number	T1 (UNF)	T2 (UNF)	List Price Steel
	<p>Male JIC X Male Pipe</p> 	2404-04-02	1/4"	1/8"
2404-02-04		1/8"	1/4"	\$0.72
2404-04-04		1/4"	1/4"	\$0.74
2404-04-06		1/4"	3/8"	\$0.75
2404-04-08		1/4"	1/2"	\$0.74
2404-06-02		3/8"	1/8"	\$0.74
2404-06-04		3/8"	1/4"	\$0.74
2404-06-06		3/8"	3/8"	\$0.81
2404-06-08		3/8"	1/2"	\$0.94
2404-06-12		3/8"	3/4"	\$1.21
2404-08-04		1/2"	1/4"	\$0.89
2404-08-06		1/2"	3/8"	\$0.87
2404-08-08		1/2"	1/2"	\$1.42
2404-08-12		1/2"	3/4"	\$2.64
2404-08-16		1/2"	1"	\$2.53
2404-10-06		5/8"	3/8"	\$1.02
2404-10-08		5/8"	1/2"	\$1.09
2404-10-12		5/8"	3/4"	\$1.74
2404-12-06		3/4"	3/8"	\$1.30
2404-12-08		3/4"	1/2"	\$2.64
2404-12-12		3/4"	3/4"	\$1.81
2404-12-16		3/4"	1"	\$2.43
2404-12-20		3/4"	1-1/4"	\$3.40
2404-16-12		1"	3/4"	\$2.40
2404-16-16		1"	1"	\$2.75
2404-16-20		1"	1-1/4"	\$3.62
2404-16-24		1"	1-1/2"	\$6.98
2404-20-12		1-1/4"	3/4"	\$3.40
2404-20-16		1-1/4"	1"	\$6.42
2404-20-20		1-1/4"	1-1/4"	\$4.19
2404-20-24		1-1/4"	1-1/2"	\$6.98
2404-24-16		1-1/2"	1"	\$6.98
2404-24-20		1-1/2"	1-1/4"	\$6.98
2404-24-24		1-1/2"	1-1/2"	\$10.09
2404-24-32		1-1/2"	2"	\$20.38
2404-32-16		2"	1"	\$20.38
2404-32-20	2"	1-1/4"	\$20.38	
2404-32-24	2"	1-1/2"	\$20.38	
2404-32-32	2"	2"	\$21.17	





HYDRAULIC HOSE COUPLINGS

Hydraulic 37 Flare To Pipe Adapters

90 Elbow Male JIC To Female Pipe

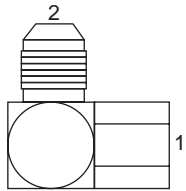
<p>Female Pipe X JIC Male</p> 	Part Number	T2 (UNF)	T1 (NPTF)	List Price Steel
	2502-04-02	1/4"	1/8"	\$1.38
	2502-04-04	1/4"	1/4"	\$1.62
	2502-05-02	5/16"	1/8"	\$1.51
	2502-05-04	5/16"	1/4"	\$1.23
	2502-06-02	3/8"	1/8"	\$1.45
	2502-06-04	3/8"	1/8"	\$1.60
	2502-06-06	3/8"	3/8"	\$2.11
	2502-06-08	3/8"	1/2"	\$2.04
	2502-08-04	1/2"	1/4"	\$2.23
	2502-08-06	1/2"	3/8"	\$2.06
	2502-08-08	1/2"	1/2"	\$2.83
	2502-08-12	1/2"	3/4"	\$4.00
	2502-10-08	5/8"	1/2"	\$2.96
	2502-10-12	5/8"	3/4"	\$4.91
	2502-12-08	3/4"	1/2"	\$2.96
	2502-12-12	3/4"	3/4"	\$4.89
	2502-16-12	1"	3/4"	\$7.92
	2502-16-16	1"	1"	\$7.62
	2502-20-20	1-1/4"	1-1/4"	\$10.87
2502-24-24	1-1/2"	1-1/2"	\$28.72	
2502-32-32	2"	2"	\$44.36	

J



HYDRAULIC HOSE COUPLINGS

Hydraulic 37 Flare To Pipe Adapters

37 Flare To Pipe

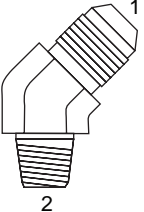
	Part Number	T1 (NPTF)	T2 (UNF)	List Price Steel
	<p>45 JIC Male X Male Pipe</p> 	2503-04-02	1/4"	1/8"
2503-04-04		1/4"	1/4"	\$1.23
2503-05-02		5/16"	1/8"	\$1.47
2503-05-04		5/16"	1/4"	\$1.45
2503-06-02		3/8"	1/8"	\$1.45
2503-06-04		3/8"	1/4"	\$1.42
2503-06-06		3/8"	3/8"	\$1.55
2503-06-08		3/8"	1/2"	\$2.23
2503-08-04		1/2"	1/4"	\$1.58
2503-08-06		1/2"	3/8"	\$1.79
2503-08-08		1/2"	1/2"	\$1.91
2503-08-12		1/2"	3/4"	\$3.00
2503-10-06		5/8"	3/8"	\$2.26
2503-10-08		5/8"	1/2"	\$2.42
2503-10-12		5/8"	3/4"	\$2.75
2503-12-08		3/4"	1/2"	\$2.91
2503-12-12		3/4"	3/4"	\$3.09
2503-12-16		3/4"	1"	\$6.91
2503-14-12		7/8"	3/4"	\$4.89
2503-16-12		1"	3/4"	\$6.91
2503-16-16	1"	1"	\$4.68	
2503-16-20	1"	1-1/4"	\$15.66	
2503-20-20	1-1/4"	1-1/4"	\$11.36	
2503-24-24	1-1/2"	1-1/2"	\$15.91	
2503-32-32	2"	2"	\$30.94	





HYDRAULIC HOSE COUPLINGS

Hydraulic 37 Flare To Pipe Adapters

37 Flare To Pipe

90 Male 37 JIC
X Male Pipe

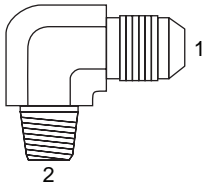

Part Number	T1 (UNF)	T2 (UNF)	List Price Steel
2501-04-02	1/4"	1/8"	\$1.02
2501-04-04	1/4"	1/4"	\$0.94
2501-04-06	1/4"	3/8"	\$1.55
2501-04-08	1/4"	1/2"	\$1.62
2501-05-02	5/16"	1/8"	\$0.91
2501-05-04	5/16"	1/4"	\$1.34
2501-05-06	5/16"	3/8"	\$1.42
2501-06-02	3/8"	1/8"	\$1.30
2501-06-04	3/8"	1/4"	\$1.49
2501-06-06	3/8"	3/8"	\$2.06
2501-06-08	3/8"	1/2"	\$1.58
2501-06-12	3/8"	3/4"	\$2.89
2501-08-04	1/2"	1/4"	\$1.87
2501-08-06	1/2"	3/8"	\$1.70
2501-08-08	1/2"	1/2"	\$1.91
2501-08-12	1/2"	1/2"	\$4.72
2501-10-06	5/8"	3/8"	\$2.06
2501-10-08	5/8"	1/2"	\$2.00
2501-10-12	5/8"	3/4"	\$2.89
2501-12-08	3/4"	1/2"	\$2.92
2501-12-12	3/4"	3/4"	\$3.00
2501-12-16	3/4"	1"	\$4.34
2501-14-12	7/8"	3/4"	\$5.34
2501-16-12	1"	3/4"	\$4.77
2501-16-16	1"	1"	\$4.53
2501-20-16	1-1/4"	1"	\$9.89
2501-20-20	1-1/4"	1-1/4"	\$9.87
2501-20-24	1-1/4"	1-1/2"	\$17.28
2501-24-20	1-1/2"	1-1/4"	\$12.85
2501-24-24	1-1/2"	1-1/2"	\$16.68
2501-32-32	2"	2"	\$29.60

J



HYDRAULIC HOSE COUPLINGS

Hydraulic 37 Flare To Pipe Adapters

37 Flare To Pipe

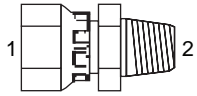
<p>JIC Swivel Female X Male Pipe</p> 	Part Number	T1 (UNF)	T2 (NPTF)	List Price Steel
	6505-04-04	1/4"	1/4"	\$1.40
	6505-06-04	3/8"	1/4"	\$1.81
	6505-06-06	3/8"	3/8"	\$1.81
	6505-08-08	1/2"	1/2"	\$2.13
	6505-10-08	5/8"	1/2"	\$2.13
	6505-10-12	5/8"	3/4"	\$2.13
	6505-12-12	3/4"	3/4"	\$2.92
	6505-16-12	1"	3/4"	\$6.08
	6505-16-16	1"	1"	\$6.08
	6505-20-20	1-1/4"	1-1/4"	\$7.38
	6505-24-24	1-1/2"	1-1/2"	\$8.30

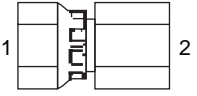

37 Flare To Pipe

<p>JIC Swivel Female X Female Pipe</p> 	Part Number	T1 (UNF)	T2 (NPTF)	List Price Steel
	6506-04-04	1/4"	1/4"	\$1.53
	6506-06-06	3/8"	3/8"	\$2.45
	6506-06-08	3/8"	1/2"	\$1.72
	6506-08-06	1/2"	3/8"	\$2.47
	6506-08-08	1/2"	1/2"	\$2.87
	6506-10-08	5/8"	1/2"	\$3.83
	6506-12-12	3/4"	3/4"	\$5.34
	6506-16-16	1"	1"	\$6.77
	6506-20-20	1-1/4"	1-1/4"	\$9.40
	6506-24-24	1-1/2"	1-1/2"	\$11.43



HYDRAULIC HOSE COUPLINGS

Hydraulic 37 Flare To Pipe Adapters

37 Flare To Pipe

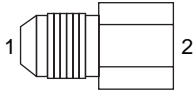
<p>JIC Male X Female Pipe</p> 	Part Number	T1 (UNF)	T2 (NPTF)	List Price Steel
	2405-04-02	1/4"	1/8"	\$0.85
	2405-04-04	1/4"	1/4"	\$0.85
	2405-05-02	5/16"	1/8"	\$0.72
	2405-05-04	5/16"	1/4"	\$1.17
	2405-06-04	3/8"	1/4"	\$0.79
	2405-06-06	3/8"	3/8"	\$0.94
	2405-06-08	3/8"	1/2"	\$1.04
	2405-08-04	1/2"	1/4"	\$0.98
	2405-08-06	1/2"	3/8"	\$1.06
	2405-08-08	1/2"	1/2"	\$1.32
	2405-10-06	5/8"	3/8"	\$1.28
	2405-10-08	5/8"	1/2"	\$2.89
	2405-12-08	3/4"	1/2"	\$2.40
	2405-12-12	3/4"	3/4"	\$2.40
	2405-14-12	7/8"	3/4"	\$3.15
	2405-16-12	1"	3/4"	\$3.40
	2405-16-16	1"	1"	\$3.53
	2405-20-16	1-1/4"	1"	\$6.23
	2405-20-20	1-1/4"	1-1/4"	\$5.83
2405-24-24	1-1/2"	1-1/2"	\$8.23	
2405-32-32	2"	2"	\$21.17	

J

37 Flare To Pipe

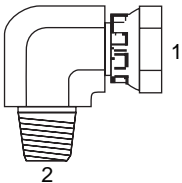
<p>90 JIC Swivel Female X Male Pipe</p> 	Part Number	T1 (UNF)	T2 (NPTF)	List Price Steel
	6501-04-02	1/4"	1/8"	\$1.64
	6501-04-04	1/4"	1/4"	\$1.64
	6501-06-04	3/8"	1/4"	\$1.64
	6501-06-06	3/8"	3/8"	\$3.04
	6501-06-08	3/8"	1/2"	\$2.09
	6501-08-06	1/2"	3/8"	\$2.09
	6501-08-08	1/2"	1/2"	\$3.08
	6501-10-08	5/8"	1/2"	\$3.08
	6501-12-12	3/4"	3/4"	\$4.23
	6501-14-12	7/8"	3/4"	\$4.23
	6501-16-16	1"	1"	\$6.21
	6501-20-20	1-1/4"	1-1/4"	\$15.13
	6501-24-24	1-1/2"	1-1/2"	\$25.96
	6501-32-32	2"	2"	\$33.47



HYDRAULIC HOSE COUPLINGS

Jic Union

SAE 37 To (JIC) Adapters

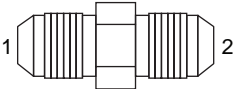
	Part Number	T1 (UNF)	T2 (UNF)	List Price Steel
	<p>JIC Male X JIC Male</p> 	2403-04-04	1/4"	1/4"
2403-05-04		5/16"	5/16"	\$0.64
2403-06-04		3/8"	1/4"	\$0.70
2403-06-06		3/8"	5/16"	\$0.75
2403-08-04		1/2"	1/4"	\$0.83
2403-08-06		1/2"	3/8"	\$1.00
2403-08-08		1/2"	1/2"	\$1.00
2403-10-06		5/8"	3/8"	\$0.94
2403-10-08		5/8"	1/2"	\$0.91
2403-10-10		5/8"	5/8"	\$1.38
2403-12-08		3/4"	1/2"	\$1.77
2403-12-12		3/4"	3/4"	\$2.62
2403-14-14		7/8"	7/8"	\$2.40
2403-16-12		1"	3/4"	\$2.57
2403-16-16		1"	1"	\$4.28
2403-20-16		1-1/4"	1"	\$4.32
2403-20-20		1-1/4"	1-1/4"	\$5.60
2403-24-24		1-1/2"	1-1/2"	\$7.32
2403-32-32		2"	2"	\$19.06

SAE 37 To JIC

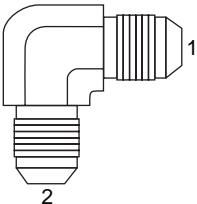
	Part Number	T1 (UNF)	T2 (UNF)	List Price Steel
	<p>90 Degree Union Elbow</p> 	2500-04-04	1/4"	1/4"
2500-05-05		5/16"	5/16"	\$1.13
2500-06-04		3/8"	1/4"	\$1.30
2500-06-06		3/8"	3/8"	\$1.23
2500-08-06		1/2"	3/8"	\$1.38
2500-08-08		1/2"	1/2"	\$1.66
2500-10-08		5/8"	1/2"	\$1.74
2500-10-10		5/8"	5/8"	\$2.06
2500-12-08		3/4"	1/2"	\$3.45
2500-12-12		3/4"	3/4"	\$4.32
2500-14-14		7/8"	7/8"	\$4.74
2500-16-12		1"	3/4"	\$5.09
2500-16-16		1"	1"	\$5.09
2500-20-20		1-1/4"	1-1/4"	\$10.55
2500-24-24		1-1/2"	1-1/2"	\$17.51
2500-32-32		2"	2"	\$42.72





HYDRAULIC HOSE COUPLINGS

SAE 37 To (JIC) Adapters

IC Swivel 90

90 Degree Swivel Elbow

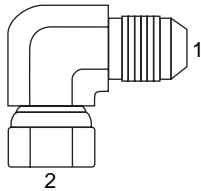

J

Part Number	T1 (UNF)	T2 (UNF)	List Price Stainless Steel
6500-04-04	1/4"	1/4"	\$1.23
6500-05-05	5/16"	5/16"	\$1.36
6500-06-04	3/8"	1/4"	\$1.81
6500-06-06	3/8"	3/8"	\$1.77
6500-06-08	3/8"	1/2"	\$2.30
6500-08-06	1/2"	3/8"	\$2.19
6500-08-08	1/2"	1/2"	\$2.15
6500-08-10	1/2"	5/8"	\$4.11
6500-10-08	5/8"	1/2"	\$4.04
6500-10-10	5/8"	5/8"	\$2.81
6500-12-10	3/4"	5/8"	\$5.41
6500-12-12	3/4"	3/4"	\$3.74
6500-14-14	7/8"	7/8"	\$6.91
6500-16-16	1"	1"	\$6.08
6500-20-20	1-1/4"	1-1/4"	\$15.13
6500-24-24	1-1/2"	1-1/2"	\$21.81
6500-32-32	2"	2"	\$37.64

IC Swivel Elbow 45

45 Degree Swivel Elbow

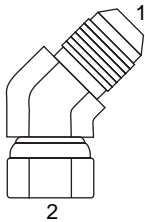

Part Number	T1 (UNF)	T2 (UNF)	List Price Steel
6502-04-04	1/4"	1/4"	\$1.70
6502-05-05	5/16"	5/16"	\$2.11
6502-06-06	3/8"	3/8"	\$1.77
6502-08-08	1/2"	1/2"	\$1.98
6502-10-10	5/8"	5/8"	\$3.32
6502-12-12	3/4"	3/4"	\$3.89
6502-14-14	7/8"	7/8"	\$5.04
6502-16-16	1"	1"	\$7.02
6502-20-20	1-1/4"	1-1/4"	\$14.00
6502-24-24	1-1/2"	1-1/2"	\$19.43
6502-32-32	2"	2"	\$36.45



HYDRAULIC HOSE COUPLINGS

JIC To O-Ring Adapters

JIC To O-Ring

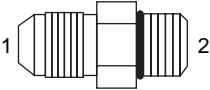
	Part Number	T1 (UNF)	T2 (UNF)	List Price Steel
	Straight Thread Connector Short 	6400-02-02	1/8"	1/8"
6400-03-03		3/16"	3/16"	\$0.58
6400-04-04		1/4"	1/4"	\$0.62
6400-04-05		1/4"	5/16"	\$0.70
6400-04-06		1/4"	3/8"	\$0.75
6400-04-08		1/4"	1/2"	\$0.94
6400-05-04		5/16"	1/4"	\$0.64
6400-05-05		5/16"	5/16"	\$0.81
6400-05-06		5/16"	3/8"	\$0.87
6400-06-04		3/8"	1/4"	\$0.75
6400-06-05		3/8"	5/16"	\$0.79
6400-06-06		3/8"	3/8"	\$0.74
6400-06-08		3/8"	1/2"	\$0.92
6400-06-10		3/8"	5/8"	\$1.17
6400-06-12		3/8"	3/4"	\$1.32
6400-08-04		1/2"	1/4"	\$0.89
6400-08-06		1/2"	3/8"	\$0.92
6400-08-08		1/2"	1/2"	\$0.98
6400-08-10		1/2"	5/8"	\$2.06
6400-08-12		1/2"	3/4"	\$1.57
6400-08-16		1/2"	1"	\$2.55
6400-10-06		5/8"	3/8"	\$1.00
6400-10-08		5/8"	1/2"	\$1.34
6400-10-10		5/8"	5/8"	\$1.34
6400-10-12		5/8"	3/4"	\$1.68
6400-10-14		5/8"	7/8"	\$2.32
6400-12-08		3/4"	1/2"	\$1.66
6400-12-10		3/4"	5/8"	\$1.70
6400-12-12		3/4"	3/4"	\$2.00
6400-12-16		3/4"	1"	\$2.58
6400-12-20		3/4"	1-1/4"	\$6.11
6400-14-14		7/8"	7/8"	\$2.40
6400-14-16		7/8"	1"	\$3.13
6400-16-10		1"	5/8"	\$4.32
6400-16-14		1"	7/8"	\$6.60
6400-16-16		1"	1"	\$3.38
6400-16-20		1"	1-1/4"	\$5.47
6400-16-24		1"	1-1/2"	\$7.58
6400-20-12		1-1/4"	3/4"	\$5.11
6400-20-16		1-1/4"	1"	\$6.11
6400-20-20	1-1/4"	1-1/4"	\$5.51	
6400-20-24	1-1/4"	1-1/2"	\$7.83	
6400-24-16	1-1/2"	1"	\$9.70	
6400-24-20	1-1/2"	1-1/4"	\$8.60	
6400-24-24	1-1/2"	1-1/2"	\$8.60	
6400-24-32	1-1/2"	2"	\$15.02	
6400-32-24	2"	1-1/2"	\$16.42	
6400-32-32	2"	2"	\$17.89	





HYDRAULIC HOSE COUPLINGS

JIC Union

IC Union

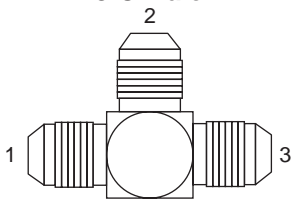
<p>JIC Male X JIC Male X JIC Male</p> 	Part Number	T1, T2, T3 (JIC) T2 (UNF)	List Price Steel
	2603-04	1/4"	\$2.62
	2603-05	5/16"	\$1.77
	2603-06	3/8"	\$1.75
	2603-08	1/2"	\$2.38
	2603-10	5/8"	\$3.06
	2603-12	3/4"	\$4.55
	2603-14	7/8"	\$6.57
	2603-16	1"	\$8.42
	2603-20	1-1/4"	\$15.94
	2603-24	1-1/2"	\$18.42
	2603-32	2"	\$45.15

37 Flare To Pipe Adapters

To Male O-Ring Boss To Female NPTF

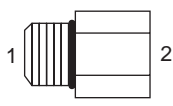
<p>Male O-Ring X Female Pipe</p> 	Part Number	T1 (NPTF)	T2 (ORB)	List Price Steel
	6405-04-02	1/4"	1/8"	\$0.92
	6405-04-04	1/4"	1/4"	\$0.96
	6405-05-02	5/16"	1/8"	\$0.98
	6405-05-04	5/16"	1/4"	\$1.04
	6405-06-04	3/8"	1/4"	\$1.09
	6405-06-06	3/8"	3/8"	\$1.11
	6405-06-08	3/8"	1/2"	\$1.06
	6405-08-04	1/2"	1/4"	\$1.17
	6405-08-06	1/2"	3/8"	\$1.23
	6405-08-08	1/2"	1/2"	\$1.51
	6405-10-06	5/8"	3/8"	\$2.30
	6405-10-08	5/8"	1/2"	\$1.83
	6405-10-12	5/8"	3/4"	\$3.58
	6405-12-08	3/4"	1/2"	\$2.36
	6405-12-12	3/4"	3/4"	\$2.92
	6405-14-12	7/8"	3/4"	\$2.75
	6405-16-12	1"	3/4"	\$3.09
	6405-16-16	1"	1"	\$3.38
	6405-16-20	1"	1-1/4"	\$7.94
	6405-20-12	1-1/4"	3/4"	\$5.09
	6405-20-16	1-1/4"	1"	\$5.96
	6405-20-20	1-1/4"	1-1/4"	\$5.58
	6405-24-16	1-1/2"	1"	\$10.19
	6405-24-20	1-1/2"	1-1/4"	\$9.70
	6405-24-24	1-1/2"	1-1/2"	\$11.68
	6405-32-32	2"	2"	\$35.00

J



HYDRAULIC HOSE COUPLINGS

Male O-Ring Boss To Female Pipe Swivel

Male O-Ring X Female Pipe	Part Number	T1 (ORB)	T2 (NPSM)	List Price Steel
		6900-04-04	1/4"	1/4"
6900-04-06		1/4"	3/8"	\$1.34
6900-05-04		5/16"	1/4"	\$1.51
6900-05-08		5/16"	1/2"	\$1.51
6900-06-04		3/8"	1/4"	\$1.23
6900-06-06		3/8"	3/8"	\$1.26
6900-06-08		3/8"	1/2"	\$1.70
6900-08-04		1/2"	1/4"	\$1.81
6900-08-06		1/2"	3/8"	\$1.87
6900-08-08		1/2"	1/2"	\$1.81
6900-08-12		1/2"	3/4"	\$2.45
6900-10-06		5/8"	3/8"	\$2.08
6900-10-08		5/8"	1/2"	\$2.08
6900-10-12		5/8"	3/4"	\$2.57
6900-12-08		3/4"	1/2"	\$2.57
6900-12-12		3/4"	3/4"	\$2.34
6900-12-16		3/4"	1"	\$3.79
6900-14-12		7/8"	3/4"	\$3.06
6900-16-12		1"	3/4"	\$3.45
6900-16-16		1"	1"	\$4.04
6900-20-16	1-1/4"	1"	\$5.32	
6900-20-20	1-1/4"	1-1/4"	\$6.21	
6900-24-20	1-1/2"	1-1/4"	\$13.74	
6900-24-24	1-1/2"	1-1/2"	\$8.92	
6900-32-32	2"	2"	\$27.51	

O-Ring Boss To JIC Swivel Adapters

Male O-Ring To Female JIC Swivel

Male O-Ring X Female JIC Swivel	Part Number	T1 (UNF)	T2 (UNF)	List Price Steel
		6402-04-04	1/4"	1/4"
6402-06-04		3/8"	1/4"	\$1.26
6402-06-06		3/8"	3/8"	\$1.28
6402-08-06		1/2"	3/8"	\$1.92
6402-08-08		1/2"	1/2"	\$1.96
6402-08-12		1/2"	3/4"	\$1.96
6402-10-06		5/8"	3/8"	\$1.79
6402-10-08		5/8"	1/2"	\$1.79
6402-10-12		5/8"	3/4"	\$1.79
6402-12-08		3/4"	1/2"	\$3.30
6402-12-12		3/4"	3/4"	\$3.30
6402-16-16		1"	1"	\$4.60
6402-20-20		1-1/4"	1-1/4"	\$8.06





HYDRAULIC HOSE COUPLINGS

JIC To O-Ring Adapters

JIC To O-Ring Elbow 90

90 Male JIC X
Male O-Ring

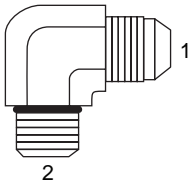

J

Part Number	T1 (UNF)	T2 (UNF)	List Price Steel
6801-04-04	1/4"	1/4"	\$1.30
6801-04-05	1/4"	5/16"	\$1.55
6801-04-06	1/4"	3/8"	\$1.13
6801-04-08	1/4"	1/2"	\$2.15
6801-05-04	5/16"	1/4"	\$1.66
6801-05-05	5/16"	5/16"	\$1.62
6801-05-06	5/16"	3/8"	\$1.74
6801-06-04	3/8"	1/4"	\$1.51
6801-06-05	3/8"	5/16"	\$1.51
6801-06-06	3/8"	3/8"	\$1.55
6801-06-08	3/8"	1/2"	\$2.87
6801-06-10	3/8"	5/8"	\$3.19
6801-06-12	3/8"	3/4"	\$3.34
6801-08-04	1/2"	1/4"	\$1.64
6801-08-06	1/2"	3/8"	\$1.91
6801-08-08	1/2"	1/2"	\$2.09
6801-08-10	1/2"	5/8"	\$2.30
6801-08-12	1/2"	3/4"	\$3.66
6801-10-06	5/8"	3/8"	\$2.53
6801-10-08	5/8"	1/2"	\$2.92
6801-10-10	5/8"	5/8"	\$2.92
6801-10-12	5/8"	3/4"	\$3.28
6801-12-06	3/4"	3/8"	\$2.74
6801-12-08	3/4"	1/2"	\$4.21
6801-12-10	3/4"	5/8"	\$4.60
6801-12-12	3/4"	3/4"	\$4.15
6801-12-14	3/4"	7/8"	\$4.83
6801-12-16	3/4"	1"	\$5.58
6801-14-12	7/8"	3/4"	\$5.36
6801-14-14	7/8"	7/8"	\$5.36
6801-16-10	1"	5/8"	\$4.53
6801-16-12	1"	3/4"	\$5.55
6801-16-14	1"	7/8"	\$5.30
6801-16-16	1"	1"	\$5.92
6801-16-20	1"	1-1/4"	\$10.96
6801-20-16	1-1/4"	1"	\$10.96
6801-20-20	1-1/4"	1-1/4"	\$14.21
6801-20-24	1-1/4"	1-1/2"	\$17.51
6801-24-16	1-1/2"	1"	\$16.58
6801-24-20	1-1/2"	1-1/4"	\$16.58
6801-24-24	1-1/2"	1-1/2"	\$17.92
6801-24-32	1-1/2"	2"	\$17.92
6801-32-24	2"	1-1/2"	\$17.92
6801-32-32	2"	2"	\$31.87



HYDRAULIC HOSE COUPLINGS

JIC To O-Ring Adapters

O-Ring To JIC Swivel Elbow 90

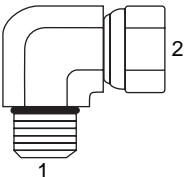
<p>Male 90 O-Ring X JIC Swivel Female</p> 	Part Number	T1 (UNF)	T2 (UNF)	List Price Steel
	6809-04-04	1/4"	1/4"	\$1.45
	6809-06-06	3/8"	3/8"	\$2.70
	6809-08-08	1/2"	1/2"	\$4.43
	6809-10-10	5/8"	5/8"	\$4.83
	6809-12-12	3/4"	3/4"	\$5.81
	6809-16-16	1"	1"	\$9.72
	6809-20-20	1-1/4"	1-1/4"	\$18.00

JIC To O-Ring Elbow 45

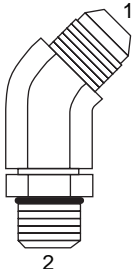
<p>45 Male JIC X Male O-Ring</p> 	Part Number	T1 (UNF)	T2 (UNF)	List Price Steel
	6802-04-04	1/4"	1/4"	\$1.49
	6802-04-06	1/4"	3/8"	\$1.47
	6802-06-04	3/8"	1/4"	\$1.75
	6802-05-05	5/16"	5/16"	\$1.83
	6802-06-06	3/8"	3/8"	\$1.70
	6802-06-08	3/8"	1/2"	\$2.60
	6802-08-06	1/2"	3/8"	\$2.49
	6802-08-08	1/2"	1/2"	\$2.40
	6802-08-10	1/2"	5/8"	\$3.02
	6802-10-08	5/8"	1/2"	\$3.08
	6802-10-10	5/8"	5/8"	\$3.19
	6802-10-12	5/8"	3/4"	\$4.26
	6802-12-10	3/4"	5/8"	\$4.34
	6802-12-12	3/4"	3/4"	\$4.49
	6802-12-16	3/4"	1"	\$5.91
	6802-14-14	7/8"	7/8"	\$4.89
	6802-16-12	1"	3/4"	\$6.02
	6802-16-16	1"	1"	\$6.47
	6802-16-20	1"	1-1/4"	\$13.66
6802-20-20	1-1/4"	1-1/4"	\$14.26	
6802-24-24	1-1/2"	1-1/2"	\$20.06	
6802-32-32	2"	2"	\$27.28	





HYDRAULIC HOSE COUPLINGS

45 O-Ring Male To Female Swivel

Male O-Ring To Female Swivel

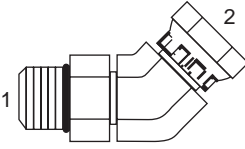
 <p>Male O-Ring X Female NPSM Swivel</p>	Part Number	T1 (ORB)	T2 (FNPSM)	List Price Steel
	6902-04-04	1/4"	1/4"	\$1.62
	6902-06-04	3/8"	1/4"	\$2.32
	6902-06-06	3/8"	3/8"	\$2.83
	6902-08-06	1/2"	3/8"	\$3.47
	6902-08-08	1/2"	1/2"	\$3.25
	6902-10-06	5/8"	3/8"	\$3.04
	6902-10-08	5/8"	1/2"	\$4.30
	6902-10-12	5/8"	3/4"	\$3.79
	6902-12-08	3/4"	1/2"	\$6.26
	6902-12-12	3/4"	3/4"	\$6.26
	6902-16-12	1"	3/4"	\$6.74
	6902-16-16	1"	1"	\$7.64
	6902-20-16	1-1/4"	1"	\$14.87
	6902-20-20	1-1/4"	1-1/4"	\$14.87
6902-24-24	1-1/2"	1-1/2"	\$21.60	

90 O-Ring Boss To Female Swivel

Male O-Ring To Female Swivel

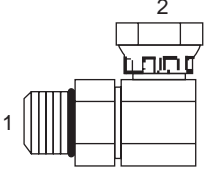
 <p>Male 90 O-Ring X Female Swivel</p>	Part Number	T1 (ORB)	T2 (NPSM)	List Price Steel
	6901-04-02	1/4"	1/8"	\$1.94
	6901-04-04	1/4"	1/4"	\$1.96
	6901-06-04	3/8"	1/4"	\$2.57
	6901-06-06	3/8"	3/8"	\$2.75
	6901-06-08	3/8"	1/2"	\$3.58
	6901-08-04	1/2"	1/4"	\$2.79
	6901-08-06	1/2"	3/8"	\$2.60
	6901-08-08	1/2"	1/2"	\$2.89
	6901-08-12	1/2"	3/4"	\$5.02
	6901-10-06	5/8"	3/8"	\$3.55
	6901-10-08	5/8"	1/2"	\$3.15
	6901-10-12	5/8"	3/4"	\$6.17
	6901-12-06	3/4"	3/8"	\$5.62
	6901-12-08	3/4"	1/2"	\$5.74
	6901-12-12	3/4"	3/4"	\$5.32
	6901-12-16	3/4"	1"	\$8.36
	6901-16-12	1"	3/4"	\$7.81
	6901-16-16	1"	1"	\$7.81
	6901-20-16	1-1/4"	1"	\$14.25
	6901-20-20	1-1/4"	1-1/4"	\$15.23
	6901-24-24	1-1/2"	1-1/2"	\$21.98
	6901-32-32	2"	2"	\$79.34



HYDRAULIC HOSE COUPLINGS

Pipe Adapters

Male NPTF To Male NPTF

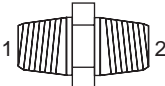
<p>Male NPTF Pipe X Male NPTF Pipe</p> 	Part Number	T1 (NPTF)	T2 (NPTF)	List Price Steel
	5404-02-02	1/8"	1/8"	\$0.62
	5404-04-02	1/4"	1/8"	\$0.68
	5404-04-04	1/4"	1/4"	\$0.74
	5404-06-02	3/8"	1/8"	\$0.74
	5404-06-04	3/8"	1/4"	\$0.79
	5404-06-06	3/8"	3/8"	\$0.83
	5404-08-04	1/2"	1/4"	\$0.98
	5404-08-06	1/2"	3/8"	\$1.02
	5404-08-08	1/2"	1/2"	\$1.04
	5404-12-08	3/4"	1/2"	\$1.64
	5404-12-12	3/4"	3/4"	\$1.81
	5404-16-12	1"	3/4"	\$3.25
	5404-16-16	1"	1"	\$3.89
	5404-20-16	1-1/4"	1"	\$5.11
	5404-20-20	1-1/4"	1-1/4"	\$5.36
	5404-24-24	1-1/2"	1-1/2"	\$8.38
5404-32-32	2"	2"	\$15.89	

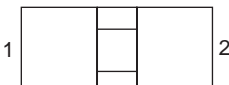

Female Pipe Union

<p>Female Pipe X Female Pipe</p> 	Part Number	T1 (NPTF)	T2 (NPTF)	List Price Steel
	5000-02-02	1/8"	1/8"	\$0.74
	5000-04-02	1/4"	1/8"	\$0.98
	5000-04-04	1/4"	1/4"	\$1.21
	5000-06-04	3/8"	1/4"	\$1.02
	5000-06-06	3/8"	3/8"	\$0.98
	5000-08-04	1/2"	1/4"	\$2.50
	5000-08-06	1/2"	3/8"	\$1.53
	5000-08-08	1/2"	1/2"	\$1.62
	5000-12-08	3/4"	1/2"	\$2.26
	5000-12-12	3/4"	3/4"	\$2.28
	5000-16-12	1"	3/4"	\$3.81
	5000-16-16	1"	1"	\$3.55
	5000-20-20	1-1/4"	1-1/4"	\$5.36
	5000-24-24	1-1/2"	1-1/2"	\$8.57
	5000-32-32	2"	2"	\$16.57



HYDRAULIC HOSE COUPLINGS

Pipe Adapters

Female NPTF 90 To Male NPTF

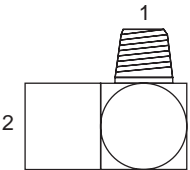
 <p>Male Pipe 90 X Female Pipe</p>	Part Number	T1 (NPTF)	T2 (NPTF)	List Price Steel
	5502-02-02	1/8"	1/8"	\$1.25
5502-02-04	1/8"	1/4"	\$1.51	
5502-04-02	1/4"	1/8"	\$1.53	
5502-04-04	1/4"	1/4"	\$1.47	
5502-04-06	1/4"	3/8"	\$2.04	
5502-06-04	3/8"	1/4"	\$2.04	
5502-06-06	3/8"	3/8"	\$2.08	
5502-08-06	1/2"	3/8"	\$2.70	
5502-06-08	3/8"	1/2"	\$2.60	
5502-08-08	1/2"	1/2"	\$2.60	
5502-12-08	3/4"	1/2"	\$3.72	
5502-08-12	1/2"	3/4"	\$6.57	
5502-12-12	3/4"	3/4"	\$3.98	
5502-16-12	1"	3/4"	\$6.45	
5502-16-16	1"	1"	\$6.64	
5502-16-20	1"	1-1/4"	\$10.28	
5502-20-16	1-1/4"	1"	\$10.94	
5502-20-20	1-1/4"	1-1/4"	\$18.41	
5502-24-24	1-1/2"	1-1/2"	\$18.32	
5502-32-32	2"	2"	\$40.70	

Female NPTF To Female NPTF 90

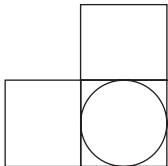
 <p>Female Pipe X Female Pipe 90</p>	Part Number	T1 (NPTF)	T2 (NPTF)	List Price Steel
	5504-02-02	1/8"	1/8"	\$1.43
5504-04-02	1/4"	1/8"	\$1.51	
5504-04-04	1/4"	1/4"	\$1.51	
5504-06-04	3/8"	1/4"	\$1.92	
5504-06-06	3/8"	3/8"	\$2.78	
5504-08-04	1/2"	1/4"	\$4.15	
5504-08-06	1/2"	3/8"	\$2.36	
5504-08-08	1/2"	1/2"	\$2.68	
5504-12-08	3/4"	1/2"	\$4.00	
5504-12-12	3/4"	3/4"	\$3.96	
5504-16-12	1"	3/4"	\$5.74	
5504-16-16	1"	1"	\$6.55	
5504-20-16	1-1/4"	1"	\$8.36	
5504-20-20	1-1/4"	1-1/4"	\$9.15	
5504-24-24	1-1/2"	1-1/2"	\$23.46	
5504-32-32	2"	2"	\$57.85	



HYDRAULIC HOSE COUPLINGS

Pipe Adapters

Female NPTF Tee

<p>Female Pipe X Female Pipe X Female Pipe</p>	Part Number	T1,T2,T3 (NPTF)	List Price Steel
	5605-02	1/8"	\$1.85
	5605-04	1/4"	\$2.32
	5605-06	3/8"	\$2.81
	5605-08	1/2"	\$3.81
	5605-12	3/4"	\$5.70
	5605-16	1"	\$8.85
	5605-20	1-1/4"	\$17.15
	5605-24	1-1/2"	\$31.32
	5605-32	2"	\$33.21

Bushing

Male NPTF To Female NPTF

<p>Male Pipe X Female Pipe</p>	Part Number	T1 (NPTF)	T2 (NPTF)	List Price Steel
	5406-04-02	1/4"	1/8"	\$0.79
	5406-06-02	3/8"	1/8"	\$0.74
	5406-06-04	3/8"	1/4"	\$0.79
	5406-08-04	1/2"	1/4"	\$0.85
	5406-08-06	1/2"	3/8"	\$0.96
	5406-08-08	1/2"	1/2"	\$1.06
	5406-12-04	3/4"	1/4"	\$1.40
	5406-12-06	3/4"	3/8"	\$1.36
	5406-12-08	3/4"	1/2"	\$1.49
	5406-16-06	1"	3/8"	\$1.94
	5406-16-08	1"	1/2"	\$2.55
	5406-16-12	1"	3/4"	\$2.66
	5406-20-08	1-1/4"	1/2"	\$4.04
	5406-20-12	1-1/4"	3/4"	\$3.83
	5406-20-16	1-1/4"	1"	\$3.85
	5406-24-08	1-1/2"	1/2"	\$5.09
	5406-24-12	1-1/2"	3/4"	\$5.09
	5406-24-16	1-1/2"	1"	\$5.45
	5406-24-20	1-1/2"	1-1/4"	\$5.45
	5406-32-08	2"	1/2"	\$10.91
	5406-32-12	2"	3/4"	\$10.92
	5406-32-16	2"	1"	\$10.92
	5406-32-20	2"	1-1/4"	\$13.45
5406-32-24	2"	1-1/2"	\$14.02	





HYDRAULIC HOSE COUPLINGS

Plugs

Pipe Plug Hex Head

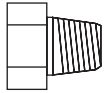
<p>Male Pipe Hex Plug</p> 	Part Number	T1 (NPTF)		List Price Steel
	5406-P-02	1/8"		\$1.00
	5406-P-04	1/4"		\$0.70
	5406-P-06	3/8"		\$0.77
	5406-P-08	1/2"		\$1.15
	5406-P-12	3/4"		\$1.58
	5406-P-16	1"		\$2.81
	5406-P-20	1-1/4"		\$3.79
	5406-P-24	1-1/2"		\$6.68
	5406-P-32	2"		\$12.85

O-Ring Plug Hex Head

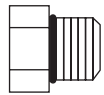
<p>Male O-Ring Hex Plug</p> 	Part Number	T1 (UNF)		List Price Steel
	6408-02	1/8"		\$0.51
	6408-03	3/16"		\$0.53
	6408-04	1/4"		\$0.60
	6408-05	5/16"		\$0.62
	6408-06	3/8"		\$0.64
	6408-08	1/2"		\$0.79
	6408-10	5/8"		\$1.02
	6408-12	3/4"		\$1.47
	6408-14	7/8"		\$1.70
	6408-16	1"		\$2.49
	6408-20	1-1/4"		\$3.25
	6408-24	1-1/2"		\$5.17
	6408-32	2"		\$10.66

JIC Plug Hex Head

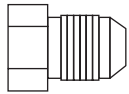
<p>Male JIC Hex Plug</p> 	Part Number	T1 (UNF)		List Price Steel
	2408-03	3/16"		\$0.55
	2408-04	1/4"		\$0.57
	2408-05	5/16"		\$0.60
	2408-06	3/8"		\$0.93
	2408-08	1/2"		\$0.74
	2408-10	5/8"		\$0.85
	2408-12	3/4"		\$1.78
	2408-14	7/8"		\$1.58
	2408-16	1"		\$1.89
	2408-20	1-1/4"		\$3.06
	2408-24	1-1/2"		\$4.19
	2408-32	2"		\$13.23



HYDRAULIC HOSE COUPLINGS

JIC Cap

Female JIC

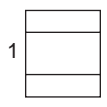
Female JIC 	Part Number	T1 (JIC)	List Price Steel
	304-C-04	1/4"	\$0.42
	304-C-05	5/16"	\$0.43
	304-C-06	3/8"	\$0.57
	304-C-08	1/2"	\$0.77
	304-C-10	5/8"	\$0.85
	304-C-12	3/4"	\$1.09
	304-C-14	7/8"	\$1.28
	304-C-16	1"	\$1.89
	304-C-20	1-1/4"	\$3.32
	304-C-24	1-1/2"	\$4.91
304-C-32	2"	\$11.58	

Anti-Seize Anaerobic Thread Sealants



50 or 250mL

AST-SEAL™ HYD (Hydraulic)

AST-SEAL™ PH (Pneumatic / Hydraulic)

Features and Benefits:

- Non-shredding / Non-contaminating.
- Made for high pressure fluid power systems.
- Easy to apply / non-destructive disassembly.
- Temperature resistance of -60° to +350°F (-51° to +176°C).



50 or 250mL

Part Number	Description	List Price
AST-SEAL™ HYD		
*22542	An excellent sealant for straight metal threads up to 1" diameter created to withstand hydraulic system pressures. Resistance to high temp, water, and non-polar solvents.	\$41.23
*22543	Same as 22542 but five times more (250mL)	\$126.51
AST-SEAL™ PH		
*22545	Designed to resist all hydraulic fluids and seal your Pneumatic / Hydraulic systems. This is a thicker non-running version of AST-SEAL™ HYD for overhead and inside machinery applications.	\$41.32
*22546	Same as 22545 but five times more (250mL)	\$126.51

* For Hydraulic Use



Pressure Washer Hose (3000psi)

Pressure washer hose with one braid. The temperature of the water can be up to 121°C.

Construction:

Tube: Black EPDM rubber .

Reinforcement: One wire braid.

Cover: Black EPDM rubber, smooth wrapped finish.

Branded: Pressure washer 3000 psi 250° F

Part Number	ID	OD	Working Pressure psi	Burst Pressure psi	Weight Per Foot	Length (Feet)	List Price Per Section
PW30003850	3/8"	0.69"	3000	9000	0.24	50	\$65.34
PW300038100	3/8"	0.69"	3000	9000	0.24	100	\$132.58
PW30005050	1/2"	0.81"	3000	9000	0.30	50	\$109.79
PW300050100	1/2"	0.81"	3000	9000	0.30	100	\$213.83
PW300050BL	1/2"	0.81"	3000	9000	0.30	50	\$72.92

Hose Bend Restrictors HB Series

Tapered design reduces bending stress near the hose coupling junction, thereby preventing damage and extending the life of the hose. The upper lip firmly attaches to the coupling, holding the restrictor in place and eliminating the use of costly adhesives or clamps. Designed to extend the life of a variety of hydraulic and pressure washer hoses.

Specifications:

- Material: Vinyl
- Color: Black



Part Number	Size	A	B	C	List Price
HB 40	1/4"	0.67"	0.76"	5.74"	\$2.15
HB 60	3/8"	0.75"	0.85"	6.43"	\$2.55
HB 80	1/2"	0.82"	0.93"	6.98"	\$3.11

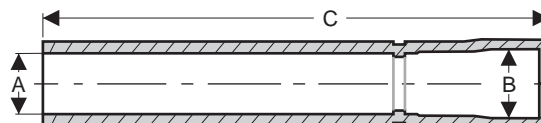

K



Pressure Washer Hose Assemblies

Tested hydrostatically to 3500 psi. There are bend restrictors on each end with male solid by male swivel.

Part Number	Hose ID	Pressure Washer Hose Assemblies	List Price
PW30003850CL	3/8"	3/8' X 50' Pressure Washer Coupled W/ Male X Male	\$78.45
PW300038100CL	3/8"	3/8' X 100' Pressure Washer Coupled W/ Male X Male	\$136.42
PW30005050CL	1/2"	1/2' X 50' Pressure Washer Coupled W/ Male X Male	\$122.72
PW300050100CL	1/2"	1/2' X 100' Pressure Washer Coupled W/ Male X Male	\$226.30
PW30003850BLCL	3/8"	3/8' X 50' Blue Pressure Washer Coupled W/ Male X Male	\$88.04



HYDRAULIC HOSE

1/4" through 1/2"
328 feet +/- one piece rolls



100R1AT R1 On Reels

Hydraulic Single Braid (Medium Pressure)

<p>This is an excellent hydraulic hose for mineral oil and glycol base liquids. Meets and exceeds SAE J517 100R1AT</p> <p>Temperature range: -40° to +210° F With peaks to 250° F</p> <p>Construction: Cover Oil and weather resistant synthetic rubber Tube Oil resistant synthetic rubber Reinforcement One steel wire braid</p> <p>The working pressure ratings are based on ambient temperature of 70° F and will vary inversely with temperature changes.</p>	Part Number	ID	OD	Working Pressure psi	Burst Pressure 70°	Weight Per 100Ft.	Bend Radius Inches	List Price Per Foot Reels
	R1AT-04	1/4"	0.53"	2750	11000	14.8	4.0	\$1.06
	R1AT-06	3/8"	0.69"	2250	9000	20.2	5.0	\$1.40
	R1AT-08	1/2"	0.82"	2000	8000	26.2	7.0	\$1.51
	R1AT-10	5/8"	0.94"	1500	6000	33.6	8.0	\$1.77
	R1AT-12	3/4"	1.10"	1250	5000	43.0	9.5	\$2.15
	R1AT-16	1"	1.35"	1000	4000	55.8	12.0	\$2.96



1/4" through 1/2"
328 feet +/- one piece rolls



100R1AT R1 Bulk Coils

Hydraulic Single Braid (Medium Pressure)

<p>This is an excellent hydraulic hose for mineral oil and glycol base liquids. Meets and exceeds SAE J517 100R1AT</p> <p>Temperature range: -40° to +210° F With peaks to 250° F</p> <p>Construction: Cover Oil and weather resistant synthetic rubber Tube Oil resistant synthetic rubber Reinforcement One steel wire braid</p> <p>The working pressure ratings are based on ambient temperature of 70° F and will vary inversely with temperature changes.</p>	Part Number	ID	OD	Working Pressure psi	Burst Pressure 70°	Weight Per 100Ft.	Bend Radius Inches	List Price Per Foot Bundled
	R1AT-04BC	1/4"	0.53"	2750	1000	14.8	4.0	\$0.91
	R1AT-06BC	3/8"	0.69"	2250	9000	20.2	5.0	\$1.25
	R1AT-08BC	1/2"	0.82"	2000	8000	26.2	7.0	\$1.36
	R1AT-10BC	5/8"	0.94"	1500	6000	33.6	8.0	\$1.62
	R1AT-12BC	3/4"	1.10"	1250	5000	43.0	9.5	\$1.98
	R1AT-16BC	1"	1.35"	1000	4000	55.8	12.0	\$2.77
	R1AT-20BC	1-1/4"	1.69"	625	2500	80.6	16.5	\$4.28
	R1AT-24BC	1-1/2"	2.05"	493	1972	94.9	20.0	\$4.85
	R1AT-32BC	2"	2.59"	327	1308	111	25.0	\$6.28



HYDRAULIC HOSE

1/4" through 1/2"
328 feet +/- one piece rolls



100R2AT R2 On Reels

Hydraulic Double Braid (High Pressure)

<p>This is an excellent hydraulic hose for mineral oil and glycol base liquids. Meets and exceeds SAE J517 100R2AT</p> <p>Temperature range: -40° to +200° F With peaks to 250° F</p> <p>Construction: Cover Oil and weather resistant synthetic rubber Tube Oil resistant synthetic rubber Reinforcement Two steel wire braids</p> <p>The working pressure ratings are based on ambient temperature of 70° F and will vary inversely with temperature changes.</p>	Part Number	ID	OD	Working Pressure psi	Burst Pressure 70°	Weight Per 100Ft.	Bend Radius Inches	List Price Per Foot Reels
	R2AT-04	1/4"	0.61"	5000	20000	23.5	4.0	\$1.32
	R2AT-06	3/8"	0.75"	4000	16000	30.9	5.0	\$1.70
	R2AT-08	1/2"	0.88"	3500	14000	42.3	7.0	\$1.96
	R2AT-10	5/8"	1.00"	2750	11000	51.1	8.0	\$2.34
	R2AT-12	3/4"	1.16"	2250	9000	63.2	9.5	\$2.75
	R2AT-16	1"	1.42"	2000	8000	80.6	12.0	\$3.91



1/4" through 1/2"
328 feet +/- one piece rolls



100R2AT R2 Bulk Coils

Hydraulic Double Braid (High Pressure)

<p>This is an excellent hydraulic hose for mineral oil and glycol base liquids. Meets and exceeds SAE J517 100R2AT</p> <p>Temperature range: -40° to +200° F With peaks to 250° F</p> <p>Construction: Cover Oil and weather resistant synthetic rubber Tube Oil resistant synthetic rubber Reinforcement Two steel wire braids</p> <p>The working pressure ratings are based on ambient temperature of 70° F and will vary inversely with temperature changes.</p>	Part Number	ID	OD	Working Pressure psi	Burst Pressure 70°	Weight Per 100Ft.	Bend Radius Inches	List Price Per Foot Bunched
	R2AT-04BC	1/4"	0.61"	5000	20000	23.5	4.0	\$1.17
	R2AT-06BC	3/8"	0.75"	4000	16000	30.9	5.0	\$1.60
	R2AT-08BC	1/2"	0.88"	3500	14000	42.3	7.0	\$1.83
	R2AT-10BC	5/8"	1.00"	2750	11000	51.1	8.0	\$2.21
	R2AT-12BC	3/4"	1.16"	2250	9000	63.2	9.5	\$2.58
	R2AT-16BC	1"	1.42"	2000	8000	80.6	12.0	\$3.72
	R2AT-20BC	1-1/4"	1.92"	1625	6500	114.0	16.5	\$6.04
	R2AT-24BC	1-1/2"	2.20"	1246	4984	147.0	20.0	\$6.08
	R2AT-32BC	2"	2.70"	1130	4520	190.0	25.0	\$7.21



100R12 R12

Hydraulic Four Spiral Steel Wire Reinforced (Heavy Duty, High Impulse)

<p>This is an excellent hydraulic hose for use with petroleum base hydraulic fluids and with water base hydraulic fluids within the temperature ranges agreed upon by us and the manufacture of the fluid. Meets and exceeds SAE J517 100R12.</p> <p>Temperature range: -40° to +250° F</p> <p>Construction: Cover: Oil and weathering resistant synthetic rubber Tube: Oil resistant synthetic rubber Reinforcement: Four spiral piles of steel wire wrapped in alternating directions.</p> <p>The working pressure ratings are based on ambient temperature of 70° F and will vary inversely with temperature changes.</p>	Part Number	ID	OD	Working Pressure psi	Burst Pressure 70°	Weight Per 100Ft.	Bend Radius Inches	List Price Per Foot Reels
	R12-6	3/8"	0.83"	4000	16000	47	4.9	\$4.81
	R12-8	1/2"	0.97"	4000	16000	50	7.1	\$5.23
	R12-10	5/8"	1.11"	4000	16000	59	7.9	\$5.91
	R12-12	3/4"	1.25"	4000	16000	71	9.4	\$5.45
	R12-16	1"	1.55"	4000	16000	107	11.8	\$6.98
	R12-20	1-1/4"	1.91"	3000	12000	159	16.5	\$8.77
	R12-24	1-1/2"	2.17"	2500	10000	181	19.7	\$10.38
	R12-32	2"	2.69"	2500	10000	226	25.2	\$13.09



100R13 R13

Hydraulic Multiple Spiral Steel Wire Reinforced (Heavy Duty, High Impulse)

<p>This is an excellent hydraulic hose for use with petroleum base hydraulic fluids and with water base hydraulic fluids within the temperature ranges agreed upon by us and the manufacture of the fluid. Meets and exceeds SAE J517 100R13.</p> <p>Temperature range: -40° to +250° F</p> <p>Construction: Cover: Oil and weathering resistant synthetic rubber Tube: Oil resistant synthetic rubber Reinforcement: Multiple spiral piles of steel wire wrapped in alternating directions.</p> <p>The working pressure ratings are based on ambient temperature of 70° F and will vary inversely with temperature changes.</p>	Part Number	ID	OD	Working Pressure psi	Burst Pressure 70°	Weight Per 100Ft.	Bend Radius Inches	List Price Per Foot Reels
	R13-12	3/4"	1.3"	5000	20000	117	9.4	\$10.47
	R13-16	1"	1.6"	5000	20000	155	11.8	\$12.55
	R13-20	1-1/4"	2"	5000	20000	249	16.5	\$14.42
	R13-24	1-1/2"	2.3"	5000	20000	313	19.7	\$18.15
	R13-32	2"	2.9"	5000	20000	464	25.2	\$22.45



HYDRAULIC HOSE & OIL RETURN



4SH

Hydraulic Four Spiral Steel Wire Reinforced (Heavy Duty, High Impulse)

The hose is suitable for use with:
Hydraulic fluids in accordance with ISO 6743-A64 with the exception of HFD R, HFD S and HFD T at temperatures ranging from -40°F to 212° F
Water based fluids at temperatures ranging from -40° F to 158° F
The hoses are not suitable for use with castor oil based on ester based fluids. Meets and exceeds **EN856-4SH**

Construction:

Cover Oil and weathering resistant synthetic rubber

Tube Oil and water resistant synthetic rubber

Reinforcement Four spiral piles of steel wire wrapped in alternating directions. Each Spiral wire ply is separated by an insulating layer of synthetic rubber.

Part Number	ID	OD	Working Pressure psi	Burst Pressure 70°	Weight Per 100Ft.	Bend Radius Inches	List Price Per Foot Reels
4SH-12	3/4"	1.30"	6000	24000	114	11.20	\$5.45
4SH-16	1"	1.57"	5500	22000	148	13.39	\$6.98
4SH-20	1-1/4"	1.85"	4700	18000	171	18.11	\$8.77
4SH-24	1-1/2"	2.17"	4200	16000	229	22.05	\$10.38
4SH-32	2"	2.74"	3600	14000	311	27.56	\$13.09

The working pressure ratings are based on ambient temperature of 70° F and will vary inversely with temperature changes.

K



SAE 100 R4 Oil Return Hose

A hydraulic suction and return hose for oil field, construction and farm equipment.

Temperature Range: -40° F to 212° F

Construction:

Tube: Black smooth nitril rubber for 50% aromatics.

Reinforcement: Spiraled high tensile textile cords and four highly flexible steel helix wire.

Cover: Neoprene rubber oil, ozone and abrasion resistant.

Part Number	ID	OD	Working Pressure psi	Burst Pressure psi	Bend Radius	Weight Per Foot	Standard Length (Feet)	List Price Per Foot
R4-12	3/4"	1.25"	300	1200	4	0.41	100	\$4.55
R4-16	1"	1.50"	250	1000	5	0.52	100	\$5.55
R4-20	1-1/4"	1.73"	200	800	6	0.62	100	\$6.83
R4-24	1-1/2"	2.00"	150	600	7	0.73	100	\$7.58
R4-32	2"	2.50"	150	600	10	0.91	100	\$10.85



HYDRAULIC HOSE ACCESSORIES

Nylotek Nylon Protective Sleeve

Part Number Per 100 Feet	Part Number Per 300 Feet	Nylotek Physical Data		List Price Per Foot
		Outside Flat "A"	Normal ID "B"	
NPS071-100	NPS071-300	1.19"	0.71"	\$0.28
NPS077-100	NPS077-300	1.25"	0.77"	\$0.32
NPS090-100	NPS090-300	1.50"	0.90"	\$0.38
NPS091-100	NPS091-300	1.50"	0.91"	\$0.40
NPS100-100	NPS100-300	1.66"	1.00"	\$0.42
NPS106-100	NPS106-300	1.72"	1.06"	\$0.42
NPS114-100	NPS114-300	1.88"	1.14"	\$0.45
NPS125-100	NPS125-300	2.03"	1.25"	\$0.55
NPS130-100	NPS130-300	2.13"	1.30"	\$0.57
NPS138-100	NPS138-300	2.25"	1.38"	\$0.58
NPS142-100	NPS142-300	2.29"	1.42"	\$0.60
NPS153-100	NPS153-300	2.50"	1.53"	\$0.62
NPS159-100	NPS159-300	2.56"	1.59"	\$0.62
NPS175-100	NPS175-300	2.81"	1.75"	\$0.70
NPS185-100	NPS185-300	3.00"	1.85"	\$0.72
NPS207-100	NPS207-300	3.31"	2.07"	\$0.81
NPS209-100	NPS209-300	3.33"	2.09"	\$0.83
NPS225-100	NPS225-300	3.63"	2.25"	\$0.92
NPS238-100	NPS238-300	3.81"	2.38"	\$0.96
NPS264-100	NPS264-300	4.25"	2.64"	\$1.06
NPS296-100	NPS296-300	4.75"	2.96"	\$1.19
NPS334-100	NPS334-300	5.31"	3.34"	\$1.23
NPS366-100	NPS366-300	5.81"	3.66"	\$1.42

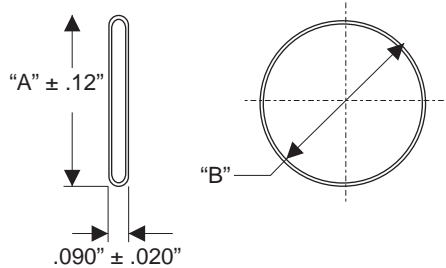

Technical Data

- ☑ **Material:** Made of bulk continuous filament nylon.
- ☑ **Thickness:** .090" ± .020" doubled flat.
- ☑ **Color:** Standard color is black.
- ☑ **Flammability:** Passes FMVSS302 horizontal flame test.
- ☑ **Temperature:** Ambient temperature of 250 °F max.
- ☑ **Packaged:** Rolls of 100 and 300 feet.

Recommendations

- ☑ Use band clamps or nylon cable ties to secure sleeve
- ☑ Heat treat cut ends to prevent fraying
- ☑ If hose has fittings installed a larger diameter sleeve may be required

Benefits

- ☑ Excellent protection for hoses from abrasion and cuts
- ☑ Useful for bundling 2 or more hoses
- ☑ Provides protection to operators of equipment from hydraulic fluids in the event of hose failures
- ☑ Reduces downtime by extending life cycles of hoses
- ☑ Easy to install allows rubber hose to move freely inside sleeve
- ☑ Can be applied over cables, chains, or springs to protect paint finishes





FIRE JACKETS



Fire Tape

Fire Tape Silicon Rubber 500°F				Self-Adhesive Tape for Hose 365°F			
Size	Part Number	Length	List Price	Size	Part Number	Length	List Price
3"	FT 300	50 FEET	\$375.47	1"	FJT100	12 Yards	\$31.79



Silicone rubber coated fiberglass sleeve (sleeving) protects hoses, cables and wire from molten metal splash, high heat hazards and occasional exposure to flame. Resistant to hydraulic fluids, fuels and lubricating oils and sheds molten metal splash. Reduces energy loss and offers personnel burn protection through insulating hot oil, steam lines or pipe surfaces. Allows the bundling of cables, hoses and wires while providing excellent thermal and abrasion resistance.

Construction: High bulk braided fiberglass sleeving and coated with a custom compounded silicone rubber designed to form a protective barrier

Temperature range: -65° F to 500°F

Color: Red

Fire Jackets

HOSE SIZE	PART NO.	LENGTH	LIST PRICE
1/4"	FJ4	50 FEET	\$91.45
3/8"	FJ6	50 FEET	\$110.49
1/2"	FJ8	50 FEET	\$121.92
5/8"	FJ10	50 FEET	\$140.96
3/4"	FJ12	50 FEET	\$154.30
7/8"	FJ14	50 FEET	\$188.60
1"	FJ16	50 FEET	\$200.02
1-1/4"	FJ20	50 FEET	\$238.13
1-1/2"	FJ24	50 FEET	\$285.75
1-3/4"	FJ28	50 FEET	\$352.43
2"	FJ32	50 FEET	\$403.87
2-1/2"	FJ40	50 FEET	\$495.32
3"	FJ48	50 FEET	\$742.98
4"	FJ64	50 FEET	\$885.87

K

Fiberglass Sleeving

HOSE SIZE	PART NO.	LENGTH	LIST PRICE
1/4"	FSL4	100 FEET	\$42.68
3/8"	FSL6	100 FEET	\$44.94
1/2"	FSL8	100 FEET	\$76.96
5/8"	FSL10	100 FEET	\$79.25
3/4"	FSL12	100 FEET	\$81.13
7/8"	FSL14	100 FEET	\$91.81
1"	FSL16	100 FEET	\$111.26
1-1/4"	FSL20	100 FEET	\$117.34
1-1/2"	FSL24	100 FEET	\$154.30
2"	FSL32	100 FEET	\$182.11
2-1/2"	FSL40	100 FEET	\$205.66
3"	FSL48	100 FEET	\$220.21
3-1/2"	FSL56	100 FEET	\$252.60
4"	FSL64	100 FEET	\$284.98

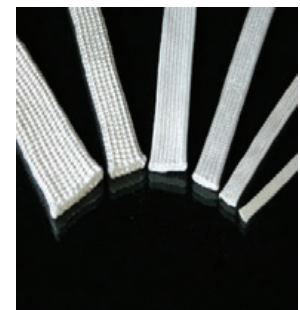

Braided texturized fiberglass tubing provides thermal insulation protection. The untreated tubing is flexible and expands to cover changing diameters.

Construction: Braided texturized fiberglass tubing

Temperature range: 1000°F

Color: White



Polyurethane Drop Hose



SERIES 1980

Designed to be Biofuel compatible, this specially formulated polyurethane drop hose handles gasoline, ethanol (up to E98), diesel and biodiesel (up to B100 meeting ASTM D6751 criteria). The polyurethane construction is non-permeable, lighter weight than conventional TPR/Rubber hose, and has superior sub-zero flexibility. The clear side wall of Series 1980 allow for easy inspection of material flow and external helix provides for easy drag.

Part Number	ID	OD	Working Pressure psi	Bend Radius Inches	Weight Per Foot	Standard Length (Feet)	List Price
1980-300	3"	3.79"	65	6"	121.0	100	\$21.70
1980-400	4"	4.80"	65	8"	171.0	100	\$28.77

Temperature range: -40° F to 150° F

Construction: Clear Polyurethane w/Polyester Braid w/Rigid Green PVC Helix (Static Wire Included)

Cover: Clear w/Green Helix



SF DROPFLEX

A lightweight petroleum drop and vacuum hose that is flexible and abrasion resistant. A static conductive tube assures no static buildup, plus the added protection of a continuous static wire. External PVC helix for abrasion resistance with black static conductive nitrile tube.

Safety Factor: 3 to 1

Temperature range: -30° F to 140° F

Construction:

Tube: Seamless black static conductive nitrile, 40% aromatic.

Reinforcement: Synthetic fabric multiple plies, PVC helix.

Cover: Nitrile

Static Grounding: Static Wire and static conductive

Part Number	ID	OD	Working Pressure psi	Bend Radius Inches	Weight Per Foot	Standard Length (Feet)	List Price
SFDF 200	2"	2.87"	100	2"	.95	100	\$16.04
SFDF 300	3"	3.87"	100	5"	1.27	100	\$21.13
SFDF 400	4"	4.87"	100	6"	1.65	19/100	\$28.21

Suction to 26" Hg at 72° F.

15% Gasohol

SF DROPFLEX SLINKY SLEEVES

Part Number	Size	Length (inch)	List Price
SL212	2"	12"	\$11.77
SL312	3"	12"	\$13.89
SL412	4"	12"	\$16.96





Seal Fast Air Hose Coupled And Uncoupled (Red)

<p>A general purpose air hose, engineered for medium applications. Temperature range: -4° F to +158° F, Tube: EPDM/NR blended / Limited oil Resistance Reinforcement: Polyester braided, Cover: EPDM/SBR blended Red</p> <p>Coupled with SFH(075 or 100) Universal Crowfoot Couplings 2 Stainless Steel Clamps Each End</p>	Hose ID	Part Number	Working Pressure psi	Burst Pressure psi	Length	List Price Per Section
	3/4"	SFAH 075 50	300	900	50'	\$86.79
	1"	SFAH 100 50	200	600	50'	\$117.66
	1"	SFAH 100-2 50	300	900	50'	\$152.53
	3/4"	SFAH 075 Coupled	300	900	50'	\$88.68
	3/4"	SFAH 075 Coupled 100	300	900	100'	\$177.36
	1"	SFAH 100 Coupled	200	600	50'	\$120.75
	1"	SFAH 100 Coupled 100	200	600	100'	\$256.62
	1"	SFAH 100-2 Coupled	300	900	50'	\$154.72



Seal Fast Air Hose Uncoupled (Black)

<p>A general purpose air hose, engineered for medium applications. Temperature range: -4° F to +158° F, Tube: EPDM/NR blended / Limited oil Resistance Reinforcement: Polyester braided, Cover: EPDM/SBR blended Black</p>	Hose ID	Part Number	Working Pressure psi	Burst Pressure psi	Weight per Foot	List Price Per Foot
	1/4"	SFAH 025 BLACK	300	900	0.09	\$0.68
	3/8"	SFAH 038 BLACK	300	900	0.14	\$0.81
	1/2"	SFAH 050 BLACK	300	900	0.19	\$1.08
	3/4"	SFAH 075 BLACK	300	900	0.34	\$1.87
	1"	SFAH 100 BLACK	200	600	0.41	\$2.40
	1-1/4"	SFAH 125 BLACK	200	600	0.81	\$4.72
	1-1/2"	SFAH 150 BLACK	200	600	1.12	\$6.55
	2"	SFAH 200 BLACK	200	600	1.22	\$9.70

K

Seal Fast Air and Water Hose



<p>A general purpose air hose, engineered for medium applications.</p> <p>Temperature range: -4° F to +158° F</p> <p>Construction:</p> <p>Tube: EPDM/NR blended / Limited oil resistance Reinforcement: Polyester braided Cover: EPDM/SBR blended Red</p>	Part Number	ID	OD	Working Pressure psi	Burst Pressure psi	Weight Per Foot	Standard Length (Feet)	List Price Per Foot
	SFAH 025	1/4"	0.523"	300	900	.123	900	\$0.64
	SFAH 038	3/8"	0.649"	300	900	.163	600	\$0.75
	SFAH 050	1/2"	0.815"	300	900	.242	600	\$1.04
	SFAH 075	3/4"	1.141"	300	900	.429	300	\$1.89
	SFAH 100-2	1"	1.440"	300	900	.537	300	\$3.26
	SFAH 100	1"	1.393"	200	600	.535	300	\$2.43
	SFAH 125	1 1/4"	1.732"	200	600	.813	100	\$4.49
	SFAH 150	1 1/2"	2.047"	200	600	1.123	100	\$5.62
	SFAH 200	2"	2.50"	200	600	1.22	100	\$10.09



Seal Fast 300# Contractors Air Hose (Yellow)



A general purpose air hose, engineered for construction applications.

Temperature range: -4° F to +158° F,

Construction:

Tube: EPDM/NR blended / Limited oil Resistance

Reinforcement: Polyester braided

Cover: EPDM/SBR blended Yellow

Part Number	ID	Working Pressure psi	Burst Pressure psi	Length	List Price Section
SFAHY 075 50	3/4"	300	900	50	\$86.79
SFAHY 075 Coupled	3/4"	300	900	50	\$105.44

Push-on Air Hose



This oil resistant hose is excellent for use with air tools, mild chemicals and various petroleum products. Special braid angle for quick secure push-on coupling retention.

Temperature range: -40° F to 212° F

Construction:

Tube: Black Nitrile

Reinforcement: Black Neoprene

Cover: One Textile Braid

Safety Factor : 3:1

Part Number	ID	OD	Working Pressure psi	Bend Radius	Weight Per Foot	Standard Length (Feet)	List Price Per Foot
PH025	1/4"	0.500"	300max	3.0	9	300	\$0.91
PH038	3/8"	0.625"	300max	3.0	12	300	\$1.13
PH050	1/2"	0.750"	300max	5.0	15	300	\$1.49



Fuel Oil Delivery Hose



General applications for transfer and delivery of fuels, oils, kerosene, diesel and other petroleum products.

Temperature range: -40°F to 180°F

Construction:

Tube: Black NBR compound

Reinforcement: 2 braid polyester cord

Cover: Red NBR compound

Part Number	ID	OD	Working Pressure psi	Burst Pressure	Weight Per Foot	Standard Length (Feet)	List Price Per Foot
FODH100	1"	1.500"	250	1000		100/125/150/175	\$6.74
FODH125	1-1/4"	1.795"	250	1000		100/125/150/175	\$8.87
FODH138	1-3/8"	1.874"	250	1000		100/125/150/175	\$10.19
FODH150	1-1/2"	2.094"	250	1000		100/125/150/175	\$11.70

*FODH is available coupled. Consult with your Seal Fast Associate for ordering.



Textile Cord Air Hose

<p>A general purpose air hose, engineered for medium to heavy-duty applications</p> <p>Temperature range: -31° F to +158° F</p> <p>Construction:</p> <p>Tube: Black synthetic rubber, oil mist resistant</p> <p>Reinforcement: 2 ply polyester tire cord</p> <p>Cover: Yellow, smooth (wrapped finish) long lasting synthetic rubber, weather, abrasion and tearing resistant (EPDM)</p>	Part Number	ID	OD	Working Pressure psi	Burst Pressure	Weight Per Foot	Standard Length (Feet)	Bend Radius (Inches)	List Price Per Foot
	TEA 050	1/2"	.83"	300	900	.22	50	4	\$2.43
	TEA 075	3/4"	1.14"	300	900	.37	50	5	\$3.21
	TEA 100	1"	1.46"	300	900	.48	50	7	\$3.87
	TEA 125	1-1/4"	1.73"	300	900	.73	50	9	\$4.53
	TEA 150	1-1/2"	1.97"	300	900	.85	50	10	\$5.09
	TEA 200	2"	2.52"	300	900	1.12	50/100	14	\$6.21
	TEA 250	2-1/2"	3.19"	300	900	1.86	50	17	\$9.62
	TEA 300	3"	3.62"	300	900	1.86	50	21	\$11.64
	TEA 400	4"	4.72"	300	900	2.75	50	36	\$17.26



Wire Air Hose

K

<p>Designed for the most severe jobs in mining, quarries, industrial and construction service, this mandrel built hose has a high margin of safety and gives a long and trouble-free service under the most arduous working conditions.</p> <p>Temperature range: -40° F to +248° F</p> <p>Construction:</p> <p>Tube: Black, smooth, synthetic rubber heat and oil mist resistant (SBR)</p> <p>Reinforcement: Plies of steel wire cord</p> <p>Cover: Yellow, smooth (wrapped finish) long lasting synthetic rubber, weather, abrasion and tearing resistant (EPDM)</p>	Part Number	ID	OD	Working Pressure psi	Burst Pressure	Weight Per Foot	Standard Length (Feet)	Bend Radius (Inches)	List Price
	WA 050	1/2"	.91"	1000	4000	.37	50	6	\$2.74
	WA 075	3/4"	1.14"	1000	4000	.50	50	9	\$2.98
	WA 100	1"	1.42"	800	3200	.65	50	12	\$3.40
	WA 125	1-1/4"	1.69"	800	3200	.80	50	15	\$5.62
	WA 150	1-1/2"	1.97"	800	3200	1.05	50	18	\$5.94
	WA 200	2"	2.52"	600	2400	1.50	50	24	\$7.98
	WA 250	2-1/2"	3.07"	500	2000	2.00	50	31	\$14.15
	WA 300	3"	3.62"	500	2000	2.50	50	36	\$19.34
	WA 400	4"	4.80"	500	2000	3.90	50	48	\$32.55



WATER SUCTION & STEAM HOSE

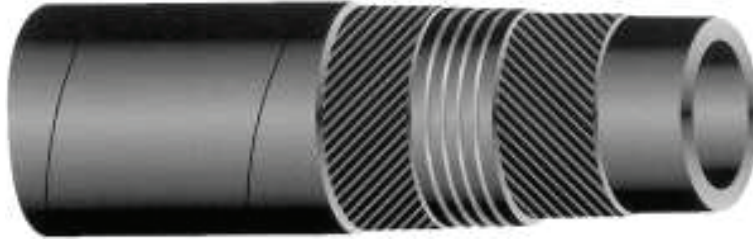

Water Suction Contractors (EPDM Blend)

Designed to meet almost all water hose applications, especially designed for use in construction, mining, industrial, and agricultural service. It is flexible and withstands high vacuum

Temperature range: -31°F to 158°F

Construction:

Tube: EPDM blend

Reinforcement: High tensile synthetic cord, incorporating wire helix

Cover: EPDM blend, resistant to abrasion and weathering

Part Number	ID	OD	Working Pressure psi	Burst Pressure	Weight Per Foot	Standard Length (Feet)	Bend Radius (Inches)	List Price Per Foot
CWS 100	1"	1.37"	150	450	.50	100	5	\$3.79
CWS 125	1-1/4"	1.65"	150	450	.60	100	5	\$4.62
CWS 150	1-1/2"	1.89"	150	450	.82	50/60/100	6	\$4.89
CWS 200	2"	2.44"	150	450	1.01	50/60/100	8	\$5.79
CWS 250	2-1/2"	3.00"	150	450	1.50	50/60/100	10	\$7.55
CWS 300	3"	3.50"	150	450	1.75	50/60/100	12	\$7.96
CWS 400	4"	4.57"	100	300	2.40	50/60/100	16	\$12.45
CWS 600	6"	6.61"	100	300	4.84	20/25/50/60/100	24	\$25.00
CWS 800	8"	8.70"	100	300	8.10	20	32	\$43.30

Water Suction Hose

(With Cam and Groove Aluminum Couplings)



All assemblies are coupled with stainless bands

Hose ID	Part Number	Description	Clamps Per End	List Price
2"	CWS20020CEAL	2" X 20' Water Suction W/C-E AL	2	\$176.17
3"	CWS30020CEAL	3" X 20' Water Suction W/C-E AL	2	\$236.41
4"	CWS40020CEAL	4" X 20' Water Suction W/C-E AL	3	\$351.61
6"	CWS60020CEAL	6" X 20' Water Suction W/C-E AL	3	\$704.55
2"	CWS20025CEAL	2" X 25' Water Suction W/C-E AL	2	\$213.54
3"	CWS30025CEAL	3" X 25' Water Suction W/C-E AL	2	\$285.78
4"	CWS40025CEAL	4" X 25' Water Suction W/C-E AL	3	\$424.97
2"	CWS20030CEAL	2" X 30' Water Suction W/C-E AL	2	\$250.92
3"	CWS30030CEAL	3" X 30' Water Suction W/C-E AL	2	\$335.15
4"	CWS40030CEAL	4" X 30' Water Suction W/C-E AL	3	\$498.32
4"	CWS40050CEAL	4" X 50' Water Suction W/C-E AL	3	\$786.14





WATER SUCTION & STEAM HOSE

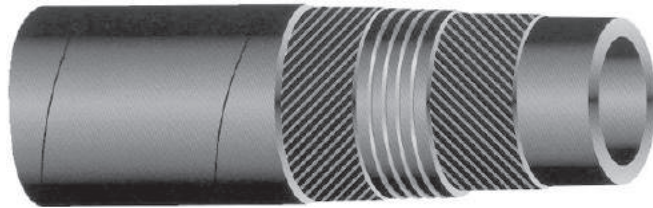

Water Suction Hose (EPDM)

<p>Water suction and delivery hose, for full suction and high discharge pressures</p> <p>Temperature range: -31° F to +158° F</p> <p>Construction: Tube: Black EPDM rubber Reinforcement: 2 ply polyester tire cord steel helix wire Cover: Smooth black EPDM rubber, weather and ozone resistant Branded: Green Stripe WS 800 is Corrugated</p>	Part Number	ID	OD	Working Pressure PSI	Burst Pressure	Weight Per Foot	Standard Length (Feet)	Bend Radius (Inches)	List Price Per Foot
	WS 150	1-1/2"	1.97"	150	450	0.85	100	6	\$5.85
	WS 200	2"	2.44"	150	450	1.01	100	8	\$7.74
	WS 250	2-1/2"	2.99"	150	450	1.55	100	10	\$9.34
	WS 300	3"	3.50"	150	450	1.75	100	12	\$9.91
	WS 400	4"	4.57"	100	300	2.40	100	16	\$17.85
	WS 600	6"	6.61"	100	300	4.84	20/100	24	\$33.68
	Corrugated WS 800	8"	8.82"	100	300	8.43	20	48	\$57.28

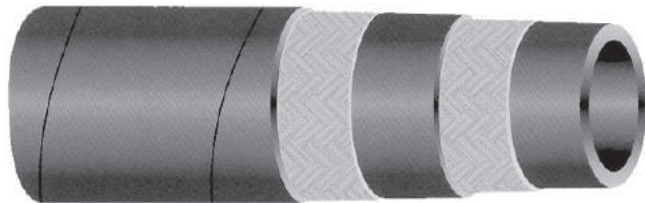

Steam Hose

<p>High pressure wire reinforced steam hose designed for service with super heated steam in heat control, fire prevention, thawing, etc., In many industries at max pressure of 17 ATM (250 psi).</p> <p>NOT RECOMMENDED FOR STEAM CLEANER.</p> <p>Safety Factor 10:1</p> <p>Temperature range: -40° F to 365° F</p> <p>Tube: Black, smooth, EPDM rubber specially compounded to withstand superheated steam</p> <p>Reinforcement: Plies of steel wire cord</p> <p>Cover: Black, smooth (wrapped finish) EPDM rubber with excellent resistance to high temperature, weathering, abrasion, ageing. It is pin pricked to prevent separation. For longer life drain after use.</p>	Part Number	ID	OD	Working Pressure psi	Burst Pressure	Weight Per Foot	Standard Length (Feet)	Bend Radius (Inches)	List Price Per Foot
	ST 050	1/2"	0.99"	250	2500	.37	50/100	6	\$4.72
	ST 075	3/4"	1.25"	250	2500	.52	50/100	9	\$4.53
	ST 100	1"	1.50"	250	2500	.65	50/100	12	\$6.36
	ST 125	1 1/4"	1.80"	250	2500	.83	50/100	15	\$9.34
	ST 150	1 1/2"	2.12"	250	2500	1.11	50/100	18	\$11.66
	ST 200	2"	2.60"	250	2500	1.50	50/100	24	\$16.51

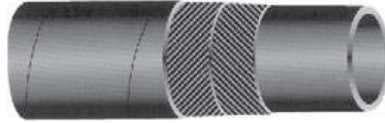

Water Discharge Hose - 2 Ply (EPDM/SBR Blend)

<p>A lightweight hose with a tough mandrel built construction, suitable for submersible pumps, irrigation and drainage systems, can be rolled up flat for storage. Temperature range: -40° F to +212° F</p> <p>Construction: Tube: Black EPDM rubber Reinforcement: 2 ply polyester tire cord Cover: Black EPDM rubber, abrasion and weather resistant Branded: Green Stripe 2PLY DISCHARGE</p>	Part Number	ID	OD	Working Pressure psi	Burst Pressure	Weight Per Foot	Standard Length (Feet)	List Price Per Foot
	DH 150-2	1 1/2"	1.77"	150	450	.40	50/100	\$4.04
	DH 200-2	2"	2.32"	150	450	.55	50/100	\$4.53
	DH 250-2	2-1/2"	2.80"	150	450	.65	50/100	\$6.04
	DH 300-2	3"	3.32"	150	450	.81	50/100	\$7.08
	DH 400-2	4"	4.32"	150	450	1.20	50/100	\$9.15
	DH 600-2	6"	6.39"	150	450	2.18	50/100	\$14.19
	DH 800-2	8"	8.39"	100	300	2.77	50	\$26.32
	DH 1000-2	10"	10.50"	100	300	4.38	50	\$48.40
	DH 1200-2	12"	12.50"	65	195	5.65	50	\$58.58

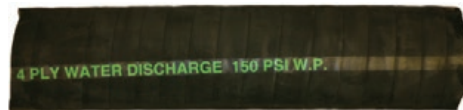

Water Discharge Hose - 4 Ply (EPDM/SBR Blend)

<p>A lightweight hose with a tough mandrel built construction, suitable for submersible pumps, irrigation and drainage systems, can be rolled up flat for storage. Temperature range: -40° F to +212° F</p> <p>Construction: Tube: Black SBR rubber Reinforcement: 4 ply polyester tire cord Cover: Black SBR rubber, abrasion and weather resistant Branded: Green Stripe 4PLY DISCHARGE 150WP</p>	Part Number	ID	OD	Working Pressure psi	Burst Pressure	Weight Per Foot	Standard Length (Feet)	List Price Per Foot
	DH 150	1 1/2"	1.85"	150	450	.62	50/100	\$4.43
	DH 200	2"	2.36"	150	450	.80	50/100	\$5.94
	DH 250	2-1/2"	2.84"	150	450	1.00	50/100	\$7.77
	DH 300	3"	3.43"	150	450	1.50	50/100	\$9.40
	DH 400	4"	4.45"	150	450	2.00	50/100	\$12.13
	DH 600	6"	6.64"	150	450	2.44	50/100	\$20.19
	DH 800	8"	8.54"	150	450	4.70	50	\$31.32
	DH 1000	10"	10.60"	150	450	5.90	50	\$61.91
	DH 1200	12"	12.60"	150	450	7.00	50	\$77.13



CRUDE OIL SUCTION HOSE

Crude Oil Suction Hose

<p>Designed for oilfield vacuum truck service. Tube and cover have resistance to crude oil. Recommended for CRUDE OIL ONLY. NOT RECOMMENDED FOR REFINED PETROLEUM PRODUCTS.</p> <p>Temperature range: -40° F to 180° F</p> <p>Construction: Tube: Neoprene blend, limited oil resistance, for oilfield use Reinforcement: Spiraled high tensile cords and steel helix wire Cover: Smooth black SBR/blend, abrasion, ozone, limited oil resistance. Branded: Blue Stripe</p>	Part Number	ID	OD	Working Pressure psi	Weight Per Foot	Standard Length (Feet)	Bend Radius (Inches)	List Price Per Foot
	COS 150	1-1/2"	1.89"	150	.80	100	7	\$5.75
	COS 200	2"	2.45"	150	1.00	100	8	\$6.38
	COS 250	2-1/2"	3.00"	150	1.26	100	10	\$10.00
	COS 300	3"	3.50"	150	1.80	100	12	\$10.53
	COS 400	4"	4.55"	150	2.30	100	15	\$13.49
	COS 600	6"	6.61"	100	5.00	20	26	\$30.47
	COS 800	8"	8.70"	100	7.60	20	35	\$46.49

With Cam and Groove Aluminum or Brass Couplings



*All standard assemblies are coupled with stainless bands. **Crimped assemblies are now available for the same price as banded. Consult with your Seal Fast Associate for ordering.**

Hose ID	Part Number	Description	Clamps Per End	List Price
2"	COS20020CEAL	2" X 20' Crude Oil Suction W/C-E AL	2	\$181.39
3"	COS30020CEAL	3" X 20' Crude Oil Suction W/C-E AL	2	\$279.01
4"	COS40020CEAL	4" X 20' Crude Oil Suction W/C-E AL	3	\$425.15
2"	COS20025CEAL	2" X 25' Crude Oil Suction W/C-E AL	2	\$218.58
3"	COS30025CEAL	3" X 25' Crude Oil Suction W/C-E AL	2	\$335.38
4"	COS40025CEAL	4" X 25' Crude Oil Suction W/C-E AL	3	\$511.58
2"	COS20030CEAL	2" X 30' Crude Oil Suction W/C-E AL	2	\$256.70
3"	COS30030CEAL	3" X 30' Crude Oil Suction W/C-E AL	2	\$393.18
4"	COS40030CEAL	4" X 30' Crude Oil Suction W/C-E AL	3	\$600.21
2"	COS20020CEBR	2" X 20' Crude Oil Suction W/C-E BR	2	\$211.59
3"	COS30020CEBR	3" X 20' Crude Oil Suction W/C-E BR	2	\$346.47
4"	COS40020CEBR	4" X 20' Crude Oil Suction W/C-E BR	3	\$516.32
2"	COS20025CEBR	2" X 25' Crude Oil Suction W/C-E BR	2	\$249.25
3"	COS30025CEBR	3" X 25' Crude Oil Suction W/C-E BR	2	\$403.56
4"	COS40025CEBR	4" X 25' Crude Oil Suction W/C-E BR	3	\$603.85
2"	COS20030CEBR	2" X 30' Crude Oil Suction W/C-E BR	2	\$286.90
3"	COS30030CEBR	3" X 30' Crude Oil Suction W/C-E BR	2	\$460.64
4"	COS40030CEBR	4" X 30' Crude Oil Suction W/C-E BR	3	\$691.38

K



Crude Oil Suction Hose "Frac Hose"

Frac Hose Temperature range: -40° F to +180° F Construction: Tube: Nitrile/SBR blend, limited oil resistance Reinforcement: 2 Ply + wire helix Cover: Black SBR blend w/blue stripe Branding: Oil field suction & discharge 100 psi W.P. (blue stripe). NOTE: Cover corrugated for increased flexibility	Part Number	ID	OD	Working Pressure psi	Plies	Weight Per Foot	Length (Inches)	Bend Radius (Inches)	List Price Per Foot
	*COS 800 40	8"	8.66"	100	2	8.05	40"	35"	\$196.23
	*COS 800 48	8"	8.66"	100	2	8.05	48"	35"	\$235.85
	*COS 800 60	8"	8.66"	100	2	8.05	60"	35"	\$294.34

***NOTE:** Cover Corrugated for Increased Flexibility With Soft Cuffs.



Tank Truck Hose

Designed for transferring gasolines and petroleum products from road tankers, barges, loading and unloading operations. It is a flexible and easy handling oil suction hose to withstand severe service condition. Temperature range: -44° F to 212° F Construction: Tube: Nitrile rubber, suitable for aromatics up to 50% Reinforcement: High tensile synthetic cords and wire helix Cover: Oil and abrasion resistant rubber Branded: Red Stripe	Part Number	ID	OD	Working Pressure psi	Burst Pressure	Weight Per Foot	Standard Length (Feet)	Bend Radius (Inches)	List Price Per Foot
	TT 100	1"	1.38"	150	450	.52	100	4	\$5.00
	TT 125	1-1/4"	1.65"	150	450	.62	100	5	\$6.19
	TT 150	1-1/2"	1.93"	150	450	.78	60/100	6	\$6.81
	TT 200	2"	2.48"	150	450	1.06	60/100	8	\$7.58
	TT 250	2-1/2"	3.00"	150	450	1.55	60/100	10	\$11.98
	TT 300	3"	3.50"	150	450	1.90	60/100	12	\$11.85
	TT 400	4"	4.57"	150	450	2.30	60/100	16	\$16.91
	TT 600	6"	6.77"	150	450	5.30	20	24	\$37.30
	TT 800	8"	8.70"	100	300	7.60	20	35	\$81.98

200 FOOT LENGTHS ARE NOW IN STOCK
For 1-1/2, 2", 3" and 4" Size



SEAL FAST COUPLED ASSEMBLIES

Tank Truck Hose (With Cam And Groove Aluminum Or Brass Couplings)



All assemblies are coupled with stainless bands, with each end of the hose grounded to the couplings. The grounding conductor is tested from coupling to coupling before we are done.

Crimped assemblies are now available for the same price as banded. Consult with your Seal Fast Associate for ordering

Hose ID	Part Number	Description Tank Truck W/Aluminum Couplings	Clamps Per End	List Price
1-1/2"	TT15020CEAL	1-1/2" X 20' Tank Truck W/C-E AL	2	\$188.92
2"	TT20020CEAL	2" X 20' Tank Truck W/C-E AL	2	\$211.91
3"	TT30020CEAL	3" X 20' Tank Truck W/C-E AL	2	\$355.05
4"	TT40020CEAL	4" X 20' Tank Truck W/C-E AL	3	\$547.53
1-1/2"	TT15025CEAL	1-1/2" X 25' Tank Truck W/C-E AL	2	\$228.58
2"	TT20025CEAL	2" X 25' Tank Truck W/C-E AL	2	\$255.98
3"	TT30025CEAL	3" X 25' Tank Truck W/C-E AL	2	\$428.95
4"	TT40025CEAL	4" X 25' Tank Truck W/C-E AL	3	\$663.30
2"	TT20030CEAL	2" X 30' Tank Truck W/C-E AL	2	\$300.04
3"	TT30030CEAL	3" X 30' Tank Truck W/C-E AL	2	\$502.86
4"	TT40030CEAL	4" X 30' Tank Truck W/C-E AL	3	\$779.07
1-1/2"	TT15050CEAL	1-1/2" X 50' Tank Truck W/C-E AL	2	\$426.87
2"	TT20050CEAL	2" X 50' Tank Truck W/C-E AL	2	\$476.30
3"	TT30050CEAL	3" X 50' Tank Truck W/C-E AL	2	\$798.50

K

Hose ID	Part Number	Description Tank Truck W/Brass Couplings	Clamps Per End	List Price
2"	TT20020CEBR	2" X 20' Tank Truck W/C-E BR	2	\$248.05
3"	TT30020CEBR	3" X 20' Tank Truck W/C-E BR	2	\$304.85
4"	TT40020CEBR	4" X 20' Tank Truck W/C-E BR	3	\$493.45
2"	TT20025CEBR	2" X 25' Tank Truck W/C-E BR	2	\$304.85
3"	TT30025CEBR	3" X 25' Tank Truck W/C-E BR	2	\$493.45
4"	TT40025CEBR	4" X 25' Tank Truck W/C-E BR	3	\$755.84
2"	TT20030CEBR	2" X 30' Tank Truck W/C-E BR	2	\$348.92
3"	TT30030CEBR	3" X 30' Tank Truck W/C-E BR	2	\$567.36
4"	TT40030CEBR	4" X 30' Tank Truck W/C-E BR	3	\$871.61



SEAL FAST COUPLED ASSEMBLIES

Tank Truck Hose

(With Cam And Groove Aluminum, Stainless Or Cast Iron Couplings)



All standard assemblies are coupled with stainless bands, with each end of the hose grounded to the couplings. The grounding conductor is tested from coupling to coupling before we are done. **Crimped assemblies are now available for the same price as banded. Consult with your Seal Fast Associate for ordering.**

Hose ID	Part Number	Description Tank Truck W/Stainless Couplings	Clamps Per End	List Price
2"	TT20020CESS	2" X 20' Tank Truck W/C-E SS	2	\$254.46
3"	TT30020CESS	3" X 20' Tank Truck W/C-E SS	2	\$444.50
4"	TT40020CESS	4" X 20' Tank Truck W/C-E SS	3	\$667.55
2"	TT20025CESS	2" X 25' Tank Truck W/C-E SS	2	\$298.52
3"	TT30025CESS	3" X 25' Tank Truck W/C-E SS	2	\$518.41
4"	TT40025CESS	4" X 25' Tank Truck W/C-E SS	3	\$783.32

Hose ID	Part Number	Description Tank Truck W/Cast Iron Couplings	Clamps Per End	List Price
2"	TT20020CECI	2" X 20' Tank Truck W/C-E Cast Iron	2	\$227.02
3"	TT30020CECI	3" X 20' Tank Truck W/C-E Cast Iron	2	\$348.39

Hose ID	Part Number	Description Tank Truck W/Alumin Adaptor & Auto-Lock Coupler	Clamps Per End	List Price
2"	TT20020CALSKEAL	2" X 20' Tank Truck W/C ALSKEAL	2	\$216.16
3"	TT30020CALSKEAL	3" X 20' Tank Truck W/C ALSKEAL	2	\$349.40
2"	TT20025CALSKEAL	2" X 25' Tank Truck W/C ALSKEAL	2	\$260.23
3"	TT30025CALSKEAL	3" X 25' Tank Truck W/C ALSKEAL	2	\$423.31
3"	TT30050CALSKEAL	3" X 50' Tank Truck W/C ALSKEAL	2	\$792.85
4"	TT40050CALSKEAL	4" X 50' Tank Truck W/C ALSKEAL	2	\$1234.43

Hose ID	Part Number	Description Tank Truck W/Aluminum Couplers	Clamps Per End	List Price
2"	TT20010CCAL	2" X 10' Tank Truck W/C-C AL	2	\$139.37
2"	TT20020CCAL	2" X 20' Tank Truck W/C-C AL	2	\$241.52
3"	TT30020CCAL	3" X 20' Tank Truck W/C-C AL	2	\$371.39
4"	TT40020CCAL	4" X 20' Tank Truck W/C-C AL	3	\$532.39
3"	TT30025CCAL	3" X 25' Tank Truck W/C-C AL	2	\$449.51





PETROLEUM & BULK HOSE



Corrugated Petroleum Hose

Designed for ease of handling where maximum flexibility is needed for transfer of gasoline, oil and other petroleum based products. Excellent kink resistance as required for bottom loading of trucks.

Temperature range: -40° F to 180° F

Construction:

Tube: Black Nitrile handles 50% Aromatic (ORS)

Reinforcement: Tire Cord, Helix Wire

Cover: Black Neoprene, (corrugated)

Ends: Soft Cuffs

Static Grounding: Use Helix Wire

Branded: Orange Stripe

Part Number	ID	OD	Working Pressure psi	Burst Pressure psi	Weight Per Foot	Standard Length (Feet)	Bend Radius (Inches)	List Price
CTT 200	2"	2.48"	150	450	1.00	100	6	\$8.81
CTT 300	3"	3.50"	150	450	1.80	100	9	\$14.55
CTT 400	4"	4.57"	150	450	2.10	100	12	\$19.98

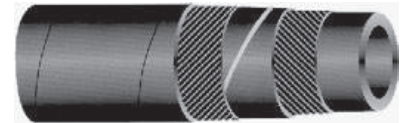

Oil Discharge Hose

Designed for handling gasoline, diesel fuels, oil sludge, fuel oils and other petroleum products. It is a flexible and easy handling petroleum discharge hose complete with built-in-anti-static wire.

Temperature range: -40° F to 180° F

Construction:

Tube: Nitrile, oil resistant, anti- static

Reinforcement: High tensile synthetic textile cords with anti-static wire

Cover: Neoprene, oil and abrasion resistant (red)

Part Number	ID	OD	Working Pressure psi	Burst Pressure psi	Weight Per Foot	Standard Length (Feet)	List Price Per Foot
ODH 150	1-1/2"	2.01"	200	600	.79	50	\$5.57
ODH 200	2"	2.48"	200	600	.93	50	\$7.98
ODH 300	3"	3.50"	200	600	1.39	50	\$12.42
ODH 400	4"	4.65"	200	600	2.29	50	\$16.91



Bulk Material Suction & Discharge Hose

Suitable for abrasive materials wet or dry. Also can be used for foodstuffs, flour, plastic pellets, etc. Tube meets FDA requirements. Ideal for sandblast return operations. Use Helix Wire for Static Grounding to couplings.

Temperature range: -25° F to 190° F

Construction:

Tube: Natural Gum Rubber

Reinforcement: Tire Cord, Helix Wire

Cover: Green, SBR (corrugated)

Ends: Soft Cuffs

Part Number	ID	OD	Working Pressure psi	Tube Gauge	Weight Per Foot	Standard Length (Feet)	Bend Radius (Inches)	List Price
BM 200	2"	2.91"	150	1/4	1.86	50	14	\$11.89
BM 300	3"	3.94"	125	1/4	2.51	50	23	\$17.83
BM 400	4"	4.96"	100	1/4	3.58	50	28	\$23.30
BM 600	6"	7.01"	75	5/16	6.32	50	42	\$45.00



XLPE Chemical Hose



Chemical Hose (XLPE Tube)

A premium hose with its special compounded cross-linked polyethylene tube, handles a wide range of chemicals, petroleum products (including aromatic) oils; highly flexible hose.

Temperature range: -40°F to +176° F

Construction:

Tube: Translucent, smooth cross-linked polyethylene

Reinforcement: 3 ply polyester tire cord and steel helix wire

Cover: Green, EPDM rubber abrasion and weather resistant

Branding: XLPE CHEMICAL S/D xxx PSI (yellow lettering)

Part Number	ID	OD	Working Pressure psi	Burst Pressure psi	Weight Per Foot	Standard Length (Feet)	Bend Radius (Inches)	List Price
CH 075	3/4"	1.25"	200	800	.48	100	3	\$6.60
CH 100	1"	1.50"	200	800	.60	100	4	\$6.13
CH 125	1-1/4"	1.77"	150	800	.70	100	6	\$7.17
CH 150	1-1/2"	2.05"	150	600	.85	100	7	\$7.96
CH 200	2"	2.60"	150	600	1.10	100	10	\$10.62
CH 250	2-1/2"	3.17"	150	600	1.90	100	17	\$13.96
CH 300	3"	3.75"	150	600	2.20	100	15	\$16.13
CH 400	4"	4.75"	150	600	3.10	100	20	\$31.42



All assemblies are coupled with stainless bands. **Crimped assemblies are now available for the same price as banded. Consult with your Seal Fast Associate for ordering.**

Hose ID	Part Number	Description XLPE W/Stainless Couplings	Clamps Per End	List Price
2"	CH20020CESS	2" X 20' XLPE Chemical Hose W/C-E SS	2	\$379.40
3"	CH30020CESS	3" X 20' XLPE Chemical Hose W/C-E SS	2	\$619.72
4"	CH40020CESS	4" X 20' XLPE Chemical Hose W/C-E SS	3	\$821.55

Hose ID	Part Number	Description XLPE W/Stainless Adapter & Sel- locking Coupler	Clamps Per End	List Price
2"	CH20020CSSKES	2" X 20' XLPE W/CSSK AND ESS	2	\$466.30
3"	CH30020CSSKES	3" X 20' XLPE W/CSSK AND ESS	2	\$772.27

Hose ID	Part Number	Description XLPE W/Stainless Couplings	Clamps Per End	List Price
2"	CH20010CESS	2" X 10' XLPE Coupled W/CESS	2	\$182.08
3"	CH30010CESS	3" X 10' XLPE Coupled W/CESS	2	\$293.61
4"	CH40010CESS	4" X 10' XLPE Coupled W/CESS	3	\$558.28

Hose ID	Part Number	Description XLPE W/Stainless Sel- locking Couplers	Clamps Per End	List Price
2"	CH20020CCSS	2" X 20' XLPE Chemical W/C/CSS	2	\$301.33
3"	CH30010CCSS	3" X 10' XLPE Chemical W/C/CSS	2	\$474.34
4"	CH40020CCSS	4" X 10' XLPE Chemical W/C/CSS	2	\$941.96

Hose ID	Part Number	Description XLPE W/Stainless Couplings	Clamps Per End	List Price
1"	CH10033CESS	1" X 33' XLPE Chemical W/C/CSS	2	\$235.97
2"	CH20033CESS	2" X 33' XLPE Chemical W/C/CSS	2	\$445.95
3"	CH30015CESS	3" X 15' XLPE Chemical W/C/CSS	2	\$378.04





Chemical Hose 240 psi WP (XLPE Tube)

<p>A premium hose with its special compounded cross-linked polyethylene tube, handles a wide range of chemicals, petroleum products (including aromatic) oils; highly flexible hose.</p> <p>Temperature range: -40°F to +176° F</p> <p>Construction: Tube: Translucent, smooth cross-linked polyethylene Reinforcement: 3 ply polyester tire cord and steel helix wire Cover: Green, EPDM rubber abrasion and weather resistant Branding: XLPE CHEMICAL S/D 240 PSI (red lettering)</p>	Part Number	ID	OD	Working Pressure psi	Burst Pressure psi	Weight Per Foot	Standard Length (Feet)	Bend Radius (Inches)	List Price
	CH 075-2	3/4"	1.22"	240	960	.42	100	3	\$8.40
	CH 100-2	1"	1.46"	240	960	.50	100	4	\$11.38
	CH 125-2	1-1/4"	1.73"	240	960	.73	100	6	\$13.38
	CH 150-2	1-1/2"	2.01"	240	960	.81	100	7	\$15.02
	CH 200-2	2"	2.56"	240	960	1.22	100	10	\$18.77
	CH 300-2	3"	3.62"	240	960	2.14	100	15	\$30.19

UHMW Chemical Hose

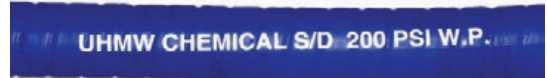

UHMW Chemical

<p>Handles 98% of common industrial chemicals in pressure, and suction service.</p> <p>Temperature range: -40°F to +176° F</p> <p>Construction: Tube: Smooth Black UHMW modified polyethylene offering hydrocarbon resistance. Reinforcement: Textile cord + double steel wire helix. Cover: Blue corrugated EPDM blend. Branding: "UHMW Chemical S/D 200 psi W.P." and White Stripe</p>	Part Number	ID	OD	Working Pressure psi	Burst Pressure psi	Weight Per Foot	Standard Length (Feet)	Bend Radius (Inches)	List Price
	UHMW 100	1"	1.50"	200	800	.54	100	4	\$6.96
	UHMW 150	1-1/2"	2.00"	200	800	.80	100	5	\$9.91
	UHMW 200	2"	2.60"	200	800	1.10	100	6	\$11.94
	UHMW 300	3"	3.65"	200	800	2.10	100	9	\$19.28
	UHMW 400	4"	4.72"	200	800	2.90	100	10	\$34.81



All assemblies are coupled with stainless bands. Crimped assemblies are now available for the same price as banded. Consult with your Seal Fast Associate for ordering.

Hose ID	Part Number	Description UHMW W/Stainless Couplings	Clamps Per End	List Price
2"	UHMW20020CESS	2" X 20' UHMW Chemical Hose W/C-E SS	2	\$319.20
3"	UHMW30020CESS	3" X 20' UHMW Chemical Hose W/C-E SS	2	\$551.05
4"	UHMW40020CESS	4" X 20' UHMW Chemical Hose W/C-E SS	3	\$976.42

Hose ID	Part Number	Description UHMW W/Stainless Adapter & Sel- locking Coupler	Clamps Per End	List Price
1"	UHMW10033CESS	1" X 33' UHMW W/C-E STAINLESS	2	\$267.51
2"	UHMW20033CESS	2" X 33' UHMW W/C-E STAINLESS	2	\$482.89



PGC & HOT AIR BLOWER HOSE



800 psi Plaster, Grout And Concrete Hose

<p>This hose is designed for pumping plaster, grout and wet concrete to construction placement sites at the rated working pressure. Temperature Range: -22° F to 179° F Construction: Tube: Black conductive NR for abrasion resistance. Reinforcement: Spiraled high tensile textile cords. Cover: Black SBR / natural rubber. Branding: Plaster/Grout/Concrete- 800 PSI W.P. (White)</p>	Part Number	ID	OD	Working Pressure psi	Burst Pressure psi	Weight Per 100 Foot	Standard Length (Feet)	Bend Radius (Inches)	List Price
	PGC 100	1"	1.57"	800	2400	.60	100	7	\$5.70
	PGC 125	1-1/4"	1.88"	800	2400	.75	100	9	\$8.83
	PGC 150	1-1/2"	2.25"	800	2400	1.06	100	10	\$11.23
	PGC 200	2"	2.75"	800	2400	1.42	100	14	\$11.77



Hot Air Blower Hose

<p>This hose is specifically designed to convey hot air from the compressor or blower on dry material unloading systems. Temperature range: +5° F to +325°F Construction: Tube: Black heat resistant EPDM rubber Reinforcement: 2 ply polyester tire cord and steel helix wire Cover: Black EPDM rubber</p>	Part Number	ID	OD	Working Pressure psi	Burst Pressure	Weight Per Foot	Standard Length (Feet)	Bend Radius (Inches)	List Price
	HAB 300	3"	3.55"	150	450	1.75	100	12	\$11.81
	HAB 400	4"	4.65"	150	450	2.40	100	16	\$19.04



Cement Discharge

<p>Temperature range: -40° F to +158° F Construction: Tube: Black, smooth, compounded for long wear resistance in handling of hard, sharp, abrasive materials, it is anti-static, 3/16" wall thickness. Reinforcement: High strength synthetic cord Cover: Black, smooth (wrapped finish) abrasion resistant synthetic rubber; it is anti-static.</p>	Part Number	ID	OD	Working Pressure psi	Burst Pressure	Weight Per Foot	Standard Length (Feet)	List Price Per Foot
	CD 400	4"	4.57"	75	225	1.70	50	\$16.70
	CD 400 100	4"	4.57"	75	225	1.70	100	\$16.70



SAND BLAST HOSE

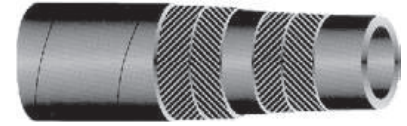

Sandblast Hose

A long lasting heavy-duty hose 2 or 4 ply, exceptionally tough and abrasion resistant, for use in sand and steel blasting service. It is manufactured from static conductive materials.

Safety Factor: 3 to 1

Construction:

Tube: Black natural rubber, static conductive.



Reinforcement: For 1/2" hose there is a 2 ply tire cord and for 3/4" to 1-1/2" there is a 4 ply tire cord.

Cover: Black synthetic rubber, abrasion and weather resistant and is also pin pricked.

Part Number	ID	OD	Working Pressure psi	Burst Pressure psi	Weight Per Foot	Standard Length (Feet)	Bend Radius (Inches)	List Price
SA 050	1/2"	1.06"	150	450	.34	50/100	3	\$4.06
SA 075	3/4"	1.50"	150	450	.62	50/100	6	\$4.96
SA 100	1"	1.89"	150	450	.96	50/100	7	\$6.13
SA 125	1-1/4"	2.17"	150	450	1.15	50/100	9	\$6.74
SA 150	1-1/2"	2.36"	150	450	1.30	50/100	10	\$8.58

*Sandblast Hose is available coupled. Consult with your Seal Fast Associate for ordering.

Sandblast Hose Couplings with screws

	Hose Ends with Crowfoot			Aluminum			Brass		
	Hose Size	Hose O. D.		Part Number	Screws Supplied	Aluminum	Part Number	Screws Supplied	Brass
	3/4"	1-1/2"	--	Q 1AL	4	\$3.77	Q 1BR	4	\$13.87
	1"	1-7/8"	--	Q 2AL	4	\$3.94	Q 2BR	4	\$14.77
	1-1/4"	2-5/32"	--	Q 3AL	8	\$5.98	Q 3BR	8	\$24.91
	1-1/2"	2-3/8"	--	Q 4AL	8	\$7.45	Q 4BR	8	\$29.91
	Hose End Nozzle Holder - NPSH Thread			Aluminum			Brass		
	Hose Size	Hose O. D.	Pipe Thd.	Part Number	Screws Supplied	Aluminum	Part Number	Screws Supplied	Brass
	3/4"	1-1/2"	1-1/4"	HE 1AL	4	\$3.75	HE 1BR	4	\$12.56
	1"	1-7/8"	1-1/4"	HE 2AL	4	\$3.77	HE 2BR	4	\$14.49
	1-1/4"	2-5/32"	1-1/4"	HE 3AL	4	\$5.38	HE 3BR	6	\$21.89
	1-1/2"	2-3/8"	1-1/4"	HE 4AL	4	\$6.32	HE 4BR	8	\$26.98
	Adapters - Crowfoot x Female NPT Pipe Thread			Aluminum, Brass & Cast Iron					
	Pipe Thd.	Part Number	Aluminum	Part Number	Brass				
	1-1/4"	SB 1AL	\$3.91	SB 1BR	\$15.28				
	1-1/2"	SB 2AL	\$3.91	SB 2BR	\$14.91				
Gaskets - Fit All Sizes - 25 per Pkg.									

K



NITRIL-PVC HOSE



Nitril 10

Nitril-PVC Layflat Discharge Hose

<p>Designed for the delivery of fluids or gases, resistant to many products such as oil, grease, acids, bases, salts, sewage and seawater.</p> <p>Construction: Color: Black Composition: Nitril-PVC oil/weather resistant rubber, polyester reinforcement Cover: Ribbed, highly resistant to oil, abrasion and weathering Service Temp: -4° to 176° F</p>	Part Number	Size	Wall Thickness	Standard Length	Working Pressure	List Price
	NITRIL 10150	1-1/2"	.08"	200'	200	\$3.19
	NITRIL 10200	2"	.08"	200'	200	\$3.75
	NITRIL 10250	2-1/2"	.08"	200'	200	\$4.15
	NITRIL 10300	3"	.08"	200'	150	\$5.98
	NITRIL 10400	4"	.08"	100/200'	150	\$7.89
	NITRIL 10600	6"	.09"	200'	150	\$13.19
	NITRIL 10800	8"	.12"	100/50/660'	100	\$28.30
	NITRIL 101000	10"	.12"	100/300'	100	\$38.02

Less weight than Rubber Discharge

Irrigation - Agriculture - Pump Discharge - Industrial Wash Down
 *660' Sections available upon request.



Nitril 20

Nitril-PVC Layflat Discharge Hose

<p>Designed for the delivery of fluids or gases, where higher working pressures are required.</p> <p>Construction: Color: Yellow or Black Composition: Nitril-PVC oil/weather resistant to oil, abrasion and weathering Cover: Ribbed, highly resistant to oil, abrasion and weathering Service Temp: -4° to 176° F</p>	Part Number Yellow	Size	Wall Thickness	Standard Length	Working Pressure	List Price
	NITRIL 20075	3/4"	.08"	200'	200	\$2.75
	NITRIL 20100	1"	.08"	200'	200	\$2.96
	NITRIL 20150	1-1/2"	.08"	200'	200	\$3.51
	NITRIL 20200	2"	.09"	200'	200	\$4.32
	NITRIL 20250	2-1/2"	.09"	200'	200	\$5.45
	NITRIL 20300	3"	.10"	200'	200	\$6.53
	NITRIL 20400	4"	.11"	200'	200	\$8.75

Irrigation - Agriculture - Pump Discharge - Industrial Wash Down



SUCTION & DISCHARGE



Series 1400 (EPDM Suction Hose)

Heavy-duty liquid suction hose ideal for construction, de-watering, liquid waste, cess pool, septic, agricultural, and marine use. Hose is designed to remain flexible in winter conditions. lightweight, and external helix provides for easy drag. The smooth interior provides for optimum product flow. Flexible for easy handling and storage.

Part Number	ID	OD	Working Pressure psi	Bend Radius (in.)	Weight Per Foot	Standard Length (Feet)	List Price Per Foot
1400-150	1 1/2"	1.84"	50	3.2	0.40	100	\$3.04
1400-200	2"	2.43"	50	5.2	0.67	100*	\$4.79
1400-300	3"	3.52"	43	7.1	1.10	100*	\$8.30
1400-400	4"	4.61"	38	11.0	1.84	100	\$14.57

Temperature range: -50° F to +225° F
Construction:
Tube: Black EPDM
Cover: Black w/ Green polypropylene

*Additional lengths available in 2" and 3" hose.
 20', 25', 33' Lengths



Series 1580 (Reinforced PVC Water Suction / Discharge Hose)

Heavy-duty PVC Suction & Discharge hose designed for applications requiring combined vacuum and higher working pressures. Excellent for use as a fish suction hose and rental / construction pumping.

Part Number	ID	OD	Working Pressure psi	Bend Radius (in)	Weight Per 100 Foot	Standard Length (Feet)	List Price Per Foot
1580-200	2"	2.60"	100	4.0	70	100	\$6.51
1580-300	3"	3.70"	100	6.3	113	100	\$8.11
1580-400	4"	4.78"	75	7.1	174	100	\$11.60
1580-600	6"	7.17"	70	10.2	388	100/20	\$26.26
1580-800	8"	9.34"	60	15.7	554	20	\$42.92

Temperature range: -13° F to +140° F

Construction:
 Clear PVC w/ Polyester Braid w/ orange PVC Helix

Color: Clear w/ orange PVC Helix

M

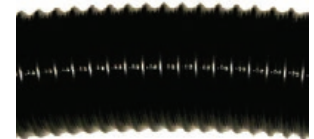

Series 1800 (Polyurethane Lined Material Handling Hose)

For "DRY" pneumatic conveying of solids where heavy-duty abrasive are present. Special formulated HMV PVC compound provides sub-zero flexibility and the exposed PVC helix allows for excellent abrasion resistance and easy drag. The smooth polyurethane lining eliminates material build up, and is formulated with static dissipating compounds.

Part Number	ID	OD	Working Pressure psi	Vacuum Rating (in Hg)	Weight Per 100 Foot	Standard Length (Feet)	List Price Per Foot
1800-200	2"	2.40"	40	29.0	59	100	\$7.13
1800-300	3"	3.65"	40	29.0	83	100	\$13.04
1800-400	4"	4.77"	35	29.0	137	100	\$20.55
1800-600	6"	6.81"	30	29.0	310	100/20	\$39.11
1800-800	8"	9.02"	30	29.0	451	20	\$65.77

Tube: Polyurethane Lined (static dissipating)
Reinforcement: High density rigid PVC helix
Cover: Black HMV PVC

Temperature range: -40° F to +150° F



SUCTION & DISCHARGE

Series 1380 (Nitril Blended Drop Hose)



Gasoline tank truck gravity drop hose. Designed to be lightweight, tough, durable and flexible. Specially designed to handle unleaded gasoline, diesel and up to 15% gasohol. It is rated up to 40% aromatic content.

Part Number	ID	OD	Working Pressure psi	Bend Radius (in.)	Weight Per Foot	Standard Length (Feet)	List Price Per Foot
1380-300	3"	3.67"	65	6	1.38	100	\$19.25
1380-400	4"	4.85"	65	8	2.19	100	\$26.38

Temperature range: -30° F to +140° F

Construction:

Tube: Black Nitril Rubber Blend

Reinforcement: Multiple Pies of Polyester w/Static Wire

Cover: Nitril w/Orange PVC Reinforcing Rod

Series 1975 (Polyurethane Vapor Recovery Hose)



Designed to be Biofuel compatible, this specially formulated polyurethane vapor recovery hose handles gasoline, ethanol (up to E98), diesel and biodiesel (up to B100 meeting ASTM D6751 criteria). The polyurethane construction is non-permeable, lighter weight than conventional TPR/Rubber hose. It has superior sub-zero flexibility.

Part Number	ID	OD	Working Pressure psi	Bend Radius (in.)	Weight Per Foot	Standard Length (Feet)	List Price Per Foot
1975-300	3"	3.55"	13	4.5	0.95	100	\$17.51

Temperature range: -40° F to +150° F

Construction:

Cover: Clear Polyurethane w/Rigid Red PVC Helix (Static Wire Included)

Series 1980 (Polyurethane Drop Hose)



M

Designed to be Biofuel compatible, this specially formulated polyurethane drop hose handles gasoline, ethanol (up to E98), diesel and biodiesel (up to B100 meeting ASTM D6751 criteria). The polyurethane construction is non-permeable, lighter weight than conventional TPR/Rubber hose, and has superior sub-zero flexibility. The clear side wall of Series 1980 allows for easy inspection of material flow and the external helix provides for easy drag.

Part Number	ID	OD	Working Pressure psi	Bend Radius (in.)	Weight Per Foot	Standard Length (Feet)	List Price Per Foot
1980-300	3"	3.79"	65	6	1.21	100	\$21.70
1980-400	4"	4.80"	65	8	1.71	100	\$28.77

Temperature range: -40° F to +150° F

Construction:

Cover: Clear Polyurethane w/Polyester Braid w/Rigid Green Helix (Static Wire Included)



PVC SUCTION HOSE

PVC Suction Hose - Green or Clear

<p>The Green Hose will handle a variety of liquid and solid materials such as water, slurry transfers, sewage, air, chemicals, grains and pellets. A versatile hose for agriculture, construction, industry and mining. The Clear Hose will handle a variety of liquids and solid materials. A versatile hose for agriculture, construction, industry and mining. The working pressure and vacuum ratings are based on ambient temperature of 70° F and will vary inversely with temperature changes.</p> <p>Safety Factor 3:1 Temperature range: -5° to 140° F Construction: Cover: Green or Clear PVC Tube: Green or Clear PVC Reinforcement: Rigid White PVC</p>	ID	Part Number	OD	Working Pressure psi	Vacuum Rating "Hg"	Weight Per 100 Foot	Standard Length (Feet)	List Price Per Foot
	3/4"	GR/CL 075	1.00"	100	29	20	100	\$0.91
	1"	GR/CL 100	1.22"	100	29	25	100	\$1.06
	1 1/4"	GR/CL 125	1.50"	90	29	34	100	\$1.34
	1 1/2"	GR/CL 150	1.79"	85	29	37	100	\$1.30
	2"	GR/CL 200	2.30"	85	29	53	100	\$1.70
	2 1/2"	GR/CL 250	2.90"	85	29	80	100	\$3.26
	3"	GR/CL 300	3.40"	75	29	91	100	\$3.09
	4"	GR/CL 400	4.40"	65	29	160	100	\$4.98
	6"	GR/CL 600	6.50"	45	29	320	100/25/20	\$10.94
8"	GR/CL 800	8.60"	35	20	510	25/20	\$25.47	



Hose ID	Part Number	Description Green and Clear PVC Suction	Clamps Per End	List Price
2"	GR20020CALXMP	2" X 20' PVC Suction W/KC Plated	2	\$53.49
2"	GR20025CALXMP	2" X 25' PVC Suction W/KC Plated	2	\$61.76
3"	GR30020CALXMP	3" X 20' PVC Suction W/KC Plated	2	\$86.42
3"	GR30025CALXMP	3" X 25' PVC Suction W/KC Plated	2	\$101.02
4"	GR40020CALXMP	4" X 20' PVC Suction W/KC Plated	3	\$133.11
6"	GR60020CALXMP	6" X 20' PVC Suction W/KC Plated	3	\$295.11
2"	GR20020CALXM	2" X 20' PVC Suction W/C AL and KC	2	\$54.80
3"	GR30020CALXM	3" X 20' PVC Suction W/C AL and KC	2	\$89.18
4"	GR40020CALXM	4" X 20' PVC Suction W/C AL and KC	3	\$136.55
6"	GR60020CALXM	6" X 20' PVC Suction W/C AL and KC	3	\$300.09
6"	GR60025CALXM	6" X 25' PVC Suction W/C AL and KC	3	\$349.42
2"	GR20020CEAL	2" X 20' PVC Suction W/C EAL	2	\$58.20
3"	GR30020CEAL	3" X 20' PVC Suction W/C EAL	2	\$93.62
4"	GR40020CEAL	4" X 20' PVC Suction W/C EAL	3	\$140.83
6"	GR60020CEAL	6" X 20' PVC Suction W/C EAL	3	\$349.78
2"	GR20025CEAL	2" X 25' PVC Suction W/C EAL	2	\$65.32
3"	GR30025CEAL	3" X 25' PVC Suction W/C EAL	2	\$106.37
4"	GR40025CEAL	4" X 25' PVC Suction W/C EAL	3	\$162.30
2"	GR20030CEAL	2" X 30' PVC Suction W/C EAL	2	\$73.55
3"	GR30030CEAL	3" X 30' PVC Suction W/C EAL	2	\$120.92
4"	GR40030CEAL	4" X 30' PVC Suction W/C EAL	3	\$184.68
2"	CL20020CEAL	2" X 20' PVC Suction W/C EAL	2	\$57.04
3"	CL30020CEAL	3" X 20' PVC Suction W/C EAL	2	\$91.78
4"	CL40020CEAL	4" X 20' PVC Suction W/C EAL	3	\$139.91
6"	CL60020CEAL	6" X 20' PVC Suction W/C EAL	3	\$317.96

M



PVC SUCTION HOSE



Sludge Suction and Discharge - Gray

The super elastic compound provides superior abrasion resistance, improved temperature range, and longer service life. This is an ideal hose for cesspool and septic tank applications. It will handle a variety of liquid and solid materials such as water, slurry transfer, sewage, air, chemicals, grains and pellets. The working pressure and vacuum ratings are based on ambient temperature of 70° F and will vary inversely with temperature changes.

Safety Factor 3:1

Temperature range: -15° to +135° F

Construction:

Cover: Gray PVC

Tube: Gray PVC

Reinforcement: Rigid White PVC with blue outer coating.

Part Number	ID	OD	Working Pressure psi	Vacuum Rating "Hg"	Weight Per 100Ft.	Standard Length (Feet)	List Price Per Foot
SL 150	1 1/2"	1.90"	70	29	47	100	\$1.81
SL 200	2"	2.40"	70	29	68	100	\$2.68
SL 300	3"	3.45"	55	29	114	100	\$4.43
SL 400	4"	4.55"	45	29	174	100	\$6.70
SL 600	6"	6.60"	35	29	322	20/25/100	\$12.40

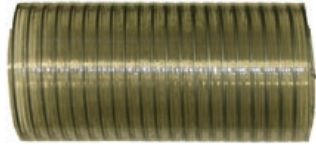

Plexisteel Clear Suction - With Wire Helix - FDA

It is ideal for suction and transport of foods and up to 28% alcoholic liquids. Good in general industrial construction, and agricultural applications. Steel helix for excellent flexibility, kink, and crush resistance. Steel helix wire can be used for static dissipation. The working pressure and vacuum ratings are based on ambient temperature of 70° F and will vary inversely with temperature changes.

Safety Factor 3:1

Temperature range: -1.4° to 140° F

Construction:

Cover: Clear PVC

Tube: Clear PVC - FDA - Blue Tint

Reinforcement: Steel wire

Part Number	ID	OD	Working Pressure psi	Vacuum Rating "Hg"	Weight Per 100 Foot	Standard Length (Feet)	List Price Per Foot
PS 075	3/4"	1.03"	100	29	21	100	\$1.04
PS 100	1"	1.32"	85	29	34	100	\$1.62
PS 125	1-1/4"	1.58"	72	29	42	100	\$2.04
PS 150	1-1/2"	1.85"	72	29	52	100	\$2.77
PS 200	2"	2.42"	72	29	84	100	\$3.89
PS 250	2-1/2"	2.95"	57	29	121	100	\$5.58
PS 300	3"	3.55"	57	29	148	100	\$7.53
PS 400	4"	4.65"	36	29	235	100	\$11.79
PS 600	6"	6.65"	28	29	429	100/20	\$21.83



All Clear Corrugated Suction - FDA

This crystal clear FDA hose has a corrugated cover for increased flexibility and a smooth bore to eliminate material build-up. Recommended for bulk handling of resin, pellets, powdery materials, as well as liquid, solid, and semi-solid food products. The working pressure and vacuum ratings are based on ambient temperature of 70° F and will vary inversely with temperature changes.

Safety Factor 3:1

Temperature range: -10° to 140° F

Construction:

Tube & Cover: Clear PVC

Reinforcement: Clear PVC helix

Part Number	ID	OD	Working Pressure psi	Vacuum Rating "Hg"	Weight Per 100 Foot	Standard Length (Feet)	List Price Per Foot
AC 150	1-1/2"	1.83"	50	29	34	100	\$1.51
AC 200	2"	2.35"	40	29	50	100	\$2.26
AC 300	3"	3.48"	40	29	100	100	\$4.43
AC 400	4"	4.60"	35	29	152	100	\$6.77

Comparable to Kuriyama WT



PVC DISCHARGE HOSE

Standard Duty Discharge - Blue

<p>Designed for water discharge applications in agriculture, construction, industry, and mining. Strong, lightweight discharge hose. Rolls up flat for easy storage. The working pressure ratings are based on ambient temperature of 70° F and will vary inversely with temperature changes. At 120°F the working pressure will be reduced to 40% of the working pressure at 70 °F</p> <p>Safety Factor 3:1 Temperature range: -5° to +130° F</p> <p>Construction: Cover: Blue PVC Tube: Blue PVC Reinforcement: Two spiral plies, one</p>	Part Number	ID	Working Pressure psi	Burst Pressure 70°	Weight Per 300Ft.	Standard Length (Feet)	List Price Per Foot
	LD 100	1"	70	294	32	300	\$0.45
	LD 125	1-1/4"	70	252	38	300	\$0.45
	LD 150	1-1/2"	70	240	42	300	\$0.55
	LD 200	2"	65	240	60	300	\$0.64
	LD 250	2-1/2"	55	195	78	300	\$0.98
	LD 300	3"	55	180	90	300	\$1.02
	LD 400	4"	50	135	120	300	\$1.43
	LD 500	5"	40	120	171	300	\$2.11
	LD 600	6"	40	120	225	300	\$2.53
	LD 800	8"	40	120	330	300	\$5.00
	LD 1000	10"	35	105	181	100	\$12.74
	LD 1200	12"	30	90	195	100	\$15.00



Hose ID	Part Number	Description Blue PVC Discharge	Clamps Per End	List Price
1-1/2"	LD15025CEAL	1-1/2" X 25' PVC Blue Discharge W/C-E AL	1	\$33.18
2"	LD20025CEAL	2" X 25' PVC Blue Discharge W/C-E AL	2	\$41.93
3"	LD30025CEAL	3" X 25' PVC Blue Discharge W/C-E AL	2	\$59.80
4"	LD40025CEAL	4" X 25' PVC Blue Discharge W/C-E AL	3	\$91.46
1-1/2"	LD15050CEAL	1-1/2" X 50' PVC Blue Discharge W/C-E AL	1	\$33.82
2"	LD20050CEAL	2" X 50' PVC Blue Discharge W/C-E AL	2	\$59.92
3"	LD30050CEAL	3" X 50' PVC Blue Discharge W/C-E AL	2	\$86.06
4"	LD40050CEAL	4" X 50' PVC Blue Discharge W/C-E AL	3	\$132.52
5"	LD50050CEAL	5" X 50' PVC Blue Discharge W/C-E AL	3	\$200.31
6"	LD60050CEAL	6" X 50' PVC Blue Discharge W/C-E AL	3	\$224.38
1-1/2"	LD15050AL150S	1-1/2" X 50' PVC Blue Discharge W/AL 150S	1	\$41.81
2"	LD20050AL200S	2" X 50' PVC Blue Discharge W/AL 200S	2	\$55.28
3"	LD30050AL300S	3" X 50' PVC Blue Discharge W/AL 300S	2	\$84.47
4"	LD40050AL400S	4" X 50' PVC Blue Discharge W/AL 400S	3	\$147.79
6"	LD60050AL600S	6" X 50' PVC Blue Discharge W/AL 600S	3	\$225.90

M



PVC DISCHARGE/SPRAY HOSE



Medium Duty Discharge - Brick Red

<p>Designed for medium duty water discharge applications in agriculture, construction, industry, and mining. Abrasion resistant PVC cover, and PVC tube provide long service life. Rolls up flat for easy storage. The working pressure ratings are based on ambient temperature of 70° F and will vary inversely with temperature changes. At 120 °F the working pressure will be reduced to 40% of the working pressure at 70 °F.</p> <p>Safety Factor 3:1 Temperature range: -10° to +150° F Construction: Cover: Red PVC Tube: Red PVC Reinforcement: Two Spiral, one longitudinal ply.</p>	Part Number	ID	Working Pressure psi	Burst Pressure 70°	Weight Per 300Ft.	Standard Length (Feet)	List Price Per Foot
	M150	1 1/2"	150	450	64lb	300	\$0.85
	M200	2"	150	450	85lb	300	\$1.23
	M250	2-1/2"	150	450	123lb	300	\$1.58
	M300	3"	150	450	145lb	300	\$1.96
	M400	4"	125	375	205lb	300	\$3.00
	M600	6"	115	345	352lb	300	\$4.15
	M800	8"	70	210	440lb	300	\$6.79

Heavy Duty Discharge - Yellow (Two Layer Construction)



<p>Designed for heavy duty water discharge applications in agriculture, construction, industry, and mining. Abrasion resistant PVC cover, and PVC tube provide long service life. Rolls up flat for easy storage. The working pressure ratings are based on ambient temperature of 70° F and will vary inversely with temperature changes. At 120 °F the working pressure will be reduced to 40% of the working pressure at 70 °F.</p> <p>Safety Factory 3:1 Temperature range: -10° to +150° F Construction: Cover: Yellow PVC Tube: Black PVC Reinforcement: Two spiral plies, one longitudinal ply. Fire Resistant MSHA 2G-60/1</p>	ID	Part Number	Working Pressure psi	Burst Pressure 70°	Weight Per 300Ft.	Standard Length (Feet)	List Price Per Foot
	8	216Y-800	150	450	804	300	\$29.34

PVC #600 Orange & #800 Green AG Spray Hose



<p>Produced with premium PVC compound for agricultural spraying of insecticides and fertilizers, water, air, and light chemical solutions. High adhesion between the tube and cover provide long service life. The working pressure ratings are based on ambient temperature of 70° F and will vary inversely with temperature changes. At 120 °F the working pressure will be reduced to (40% #600 Orange), (53% #800 Green) of the working pressure at 70 °F.</p> <p>Safety Factor 3:1 Temperature range: -10° to +150° F Construction: #600 Cover: Orange PVC Tube: Orange PVC #800 Cover: Green PVC Tube: Black PVC Reinforcement: Two spiral plies and one longitudinal ply.</p>	#600 Orange							
	Part Number	ID	OD	Working Pressure psi	Burst Pressure 70°	Weight Per 300Ft.	Standard Length (Feet)	List Price Per Foot
	342Y-025	1/4"	0.52	600	1800	24	300	\$0.34
	342Y-038	3/8"	0.64	600	1800	36	300	\$0.43
	342Y-050	1/2"	0.80	600	1800	51	300	\$0.64
	342Y-075	3/4"	1.13	600	1800	81	300	\$1.19
	#800 Green							
	Part Number	ID	OD	Working Pressure psi	Burst Pressure 70°	Weight Per 300Ft.	Standard Length (Feet)	List Price Per Foot
	380L-038	3/8"	0.67	800	2400	39	300	\$0.57
	380L-050	1/2"	0.83	800	2400	60	300	\$0.81
	380L-075	3/4"	1.16	800	2400	99	300	\$1.51





PVC AIR/TUBING HOSE

PVC Multi-Purpose Air And Water



A lightweight, economical general purpose hose for carrying, air water, and many spray solutions. Mostly used with pneumatic tools and stapler guns. The working pressure ratings are based on ambient temperature of 70°F and will vary inversely with temperature changes. At 120 °F the working pressure will be reduced to 40% of the working pressure at 70 °F.

Safety Factor: 3:1
Temperature: -10°F to +150°F

Construction:
Color: Red or Blue
Tube: Black, PVC/Nitrile
Reinforcement: 2 Spiral + 1 Longitudinal layer

On Reels

Part Number	ID	OD	Working Pressure psi	Burst Pressure 70°	Weight Per Foot	Standard Length (Feet)	List Price Per Foot
MPH 025	1/4"	0.48"	300	900	0.07	500	\$0.28
MPH 038	3/8"	0.60"	300	900	0.09	500	\$0.42
MPH 050	1/2"	0.75"	250	750	0.13	500	\$0.53
MPH 058	5/8"	0.89"	200	600	0.18	500	\$0.74
MPH 075	3/4"	1.03"	200	600	0.22	400	\$0.85
MPH 100	1"	1.31"	175	525	0.30	400	\$1.23

Please Specify Red or Blue When Ordering

Ducting



For leaf-collecting machines, manhole blowers, air conditioning and heating applications and for air ducting and pollution control devices.

It is not designed for pressure service.

Temperature range: 30° to 150° F

Flexibility 90°

Construction:

Cover: High density Clear w/white helix synthetic compound.

Tube: High density Clear w/white helix synthetic compound.

Reinforcement: Rigid white helix of high density Clear w/white helix synthetic compound.

Non-Branded

Part Number	ID	OD	Bend Radius	Vacuum Rating "Hg"	Weight Per Foot	Standard Length (Feet)	List Price Per Foot
Ducting 150	1-1/2"	1.74"	2.25	5	.18	100	\$1.51
Ducting 200	2"	2.30"	3.0	5	.28	100	\$2.34
Ducting 300	3"	3.32"	6.3	5	.46	100	\$4.68
Ducting 400	4"	4.44"	7.5	5	.66	100	\$6.32
Ducting 600	6"	6.46"	10	5	1.25	30	\$11.60

Clear Tubing (Blue Tint) FDA

Part Number	ID	OD	Working Pressure psi	Burst Pressure 70°	Weight Per 100Ft.	Standard Length (Feet)	List Price Per 100Ft.
510	1/8"	1/4"	55	165	1.78	100	\$6.79
510	3/16"	5/16"	55	165	2.5	100	\$10.09
510	1/4"	3/8"	55	165	4.00	100	\$14.68
510	1/4"	1/2"	60	180	8.25	100	\$31.51
510	5/16"	7/16"	50	150	3.75	100	\$15.38
510	5/16"	1/2"	55	165	5.25	100	\$20.09
510	3/8"	1/2"	45	135	6.25	100	\$21.98
510	3/8"	9/16"	50	150	6.30	100	\$28.60
510	3/8"	5/8"	55	165	11.25	100	\$42.55
510	1/2"	5/8"	30	90	7.50	100	\$25.92
510	1/2"	3/4"	45	135	13.25	100	\$50.85
510	5/8"	7/8"	40	120	16	100	\$61.89
510	5/8"	13/16"	35	105	11.6	100	\$44.53
510	3/4"	1"	35	105	19.50	100	\$75.11
510	7/8"	1-1/8"	30	90	19.71	100	\$81.09
510	1"	1-1/4"	25	75	26.00	100	\$99.58
510	1-1/4"	1-1/2"	20	60	28	50	\$113.96
510	1-1/2"	1-7/8"	30	90	54	50	\$210.64
510	1-1/2"	2"	35	105	74	50	\$282.83
510	2"	2-1/2"	35	105	96	50	\$368.40



The recommended procedure to maintain serviceability of PVC hose when not in use:

1. Disconnect and drain.
2. Keep hose straight and flat.
3. Avoid extreme heat and cold.
4. Store out of direct sunlight.

The working pressure ratings are based on ambient temperature of 70° F and will vary inversely with temperature changes. At 120 °F the working pressure will be reduced to 50% of the working pressure at 70 °F.



PVC AIR/TUBING HOSE

PVC Clear Braided Tubing - FDA Standard

<p>This is an excellent hose for conveying liquids, air and powdered foods. The hose is transparent, allowing for easy inspection during service.</p> <p>Safety Factor 3:1 Temperature range: -10° to +150° F</p> <p>Construction: Cover: Clear Blue Tint PVC Tube: Clear Blue Tint PVC with yellow stripe. Reinforcement: Two spiral plies and one longitudinal ply.</p> <p>The working pressure ratings are based on ambient temperature of 70° F and will vary inversely with temperature changes. At 120 °F the working pressure will be reduced to 40% of the working pressure at 70 °F.</p>	Part Number	ID	OD	Working Pressure psi	Burst Pressure 70°	Weight Per 100Ft.	Standard Length (Feet)	List Price Per Foot
	410 025	1/4"	0.44"	250	750	5.59	300	\$0.19
	410 038	3/8"	0.59"	225	675	8.21	300	\$0.28
	410 050	1/2"	0.75"	200	600	12.61	300	\$0.45
	410 058	5/8"	0.89"	200	600	16.45	300	\$0.55
	410 075	3/4"	1.03"	150	450	20.70	300	\$0.74
	410 100	1"	1.30"	125	375	30.48	300	\$1.09
	410 125	1 1/4"	1.62"	100	300	43.17	50	\$1.55
	410 150	1 1/2"	1.94"	100	300	62.88	50	\$2.26
	410 200	2"	2.49"	75	225	85.00	50	\$3.06

PVC Clear Braided Tubing - FDA Heavy Wall

<p>This is an excellent hose for conveying liquids, air and powdered foods. The hose is transparent, allowing for easy inspection during service.</p> <p>Safety Factor 3:1 Temperature range: -10° to +150° F</p> <p>Construction: Cover: Clear Blue Tint PVC Tube: Clear Blue Tint PVC with Blue stripe yarn. Reinforcement: Two spiral plies and one longitudinal ply.</p> <p>The working pressure ratings are based on ambient temperature of 70° F and will vary inversely with temperature changes. At 120 °F the working pressure will be reduced to 40% of the working pressure at 70 °F.</p>	Part Number	ID	OD	Working Pressure psi	Burst Pressure 70°	Weight Per 100Ft.	Standard Length (Feet)	List Price Per Foot
	410 025-2	1/4"	0.50"	350	1050	8.7	300	\$0.26
	410 038-2	3/8"	0.62"	275	825	16.8	300	\$0.36
	410 050-2	1/2"	0.81"	250	750	24.4	300	\$0.58
	410 058-2	5/8"	1.00"	225	675	29.5	300	\$0.85
	410 075-2	3/4"	1.13"	200	600	30.0	300	\$1.06
	410 100-2	1"	1.38"	150	450	39.0	300	\$1.40
	410 125-2	1 1/4"	1.75"	125	375	59.9	50	\$2.13
	410 150-2	1 1/2"	2.00"	100	300	74.7	50	\$2.64
	410 200-2	2"	2.50"	75	225	97.0	50	\$3.45

Premium Gardenflex

 <p>Kink resistant under pressure and abrasion resistant.</p> <p>Temperature range: -40° F to +150° F</p> <p>Construction: Premium Hybrid Polymer</p>	Part Number	Description	List Price
	GFH058050	5/8" x 50' Coupled with GHT Threads	\$64.06
	GFH058100	5/8" x 100' Coupled with GHT Threads	\$124.15

Rubber Garden Hose

 <p>COMING SOON</p>	Part Number	Description	List Price
	RGH058050	5/8" X 50' Rubber Garden Hose	\$48.00
	RGH058100	5/8" x 100' Rubber Garden Hose	\$94.32
	RGH075050	3/4" x 50' Rubber Garden Hose	\$72.45
	RGH075100	3/4" x 100' Rubber Garden Hose	\$139.40
	RGH100050	1" x 50' Rubber Garden Hose	\$89.34

Octagon Rubber Garden Hose

	Part Number	Description	List Price
	ORGH058050	5/8" X 50' Rubber Garden Hose	\$46.87





Goodyear PVC Hose

1500 Clear Suction



<p>General water suction and discharge hose for industry, agriculture, construction and septic tank cleaning. It is 50% lighter than rubber.</p> <p>Safety Factor 3:1 Temperature range: 15° to 150°F (-9°C to 66°C)</p> <p>Construction: Cover: Clear Pliovic® compound. Non-Branded Tube: Clear Pliovic® compound. Reinforcement: Rigid green Pliovic® helix</p> <p>The working pressure and vacuum ratings are based on ambient temperature of 70° F and will vary inversely with temperature changes.</p>	Part Number	ID	OD	Working Pressure psi	Vacuum Rating "Hg"	Weight Per Foot	Standard Length (Feet)	List Price Per Foot
	1500 100	1"	1.26"	106	29	0.26	100	\$2.98
	1500 150	1 1/2"	1.78"	89	29	0.41	100	\$3.06
	1500 200	2"	2.31"	79	29	0.61	100	\$4.15
	1500 300	3"	3.38"	65	29	1.11	100	\$7.45
	1500 400	4"	4.46"	55	29	1.62	100	\$11.55
	1500 600	6"	6.57"	47	29	3.44	20/25/100	\$20.66

1600 Green Suction



<p>Water suction and discharge hose for construction, septic tank cleaning, industry and agricultural applications, where mild chemical resistance is required.</p> <p>Safety Factor 3:1 Temperature range: 15° to 150°F (-9°C to 66° C)</p> <p>Construction: Cover: Olive green Pliovic® synthetic compound. Non-Branded Tube: Olive green Pliovic® compound. Reinforcement: Rigid Pliovic® compound. helix</p> <p>The working pressure and vacuum ratings are based on ambient temperature of 70° F and will vary inversely with temperature changes.</p>	Part Number	ID	OD	Working Pressure psi	Vacuum Rating "Hg"	Weight Per Foot	Standard Length (Feet)	List Price Per Foot
	1600 100	1"	1.24"	106	29	0.25	100	\$2.98
	1600 125	1 1/4"	1.53"	99	29	0.34	100	\$3.36
	1600 150	1 1/2"	1.78"	89	29	0.41	100	\$2.98
	1600 200	2"	2.32"	79	29	0.63	100	\$4.15
	1600 250	2 1/2"	2.85"	65	29	0.87	100	\$6.79
	1600 300	3"	3.44"	65	29	1.15	100	\$7.08
	1600 400	4"	4.43"	55	29	1.73	100	\$11.04
1600 600	6"	6.57"	47	29	3.17	20/25/100	\$19.77	

Blue Flat Discharge - Standard Duty (Two Layer Construction)



<p>Water discharge for construction, industry, mining, agriculture and marine service.</p> <p>Safety Factor 3:1 Temperature range: 10° to 150° F</p> <p>Construction: Cover: Blue Pliovic® Tube: Black Pliovic® Reinforcement: Two spiral and one longitudinal synthetic fiber</p> <p>The working pressure ratings are based on ambient temperature of 70° F and will vary inversely with temperature changes.</p>	Part Number	ID	OD	Working Pressure psi	Weight Per Foot	Standard Length (Feet)	List Price Per Foot
	BL150	1 1/2"	1.62"	75	0.17	300	\$1.42
	BL200	2"	2.22"	60	0.22	300	\$1.68
	BL250	2 1/2"	2.62"	60	0.29	300	\$2.68
	BL300	3"	3.26"	50	0.40	300	\$2.92
	BL400	4"	4.26"	45	0.53	300	\$3.77
	BL600	6"	6.28"	35	0.82	300	\$7.55

2700 Discharge - (Heavy Duty Two Layer Construction)



<p>For heavy duty discharge applications in mining, agriculture, construction, and marine service.</p> <p>Safety Factor 3:1 Temperature range: -10° to 150° F</p> <p>Construction: Cover: Yellow fire retardant Pliovic® MSHA 2G-14C/15 approved. Tube: Pliovic® synthetic polymers Reinforcement: Two spiral plies plus a longitudinal ply of synthetic fiber.</p> <p>The working pressure ratings are based on ambient temperature of 70° F and will vary inversely with temperature changes.</p>	Part Number	ID	OD	Working Pressure psi	Weight Per Foot	Standard Length (Feet)	List Price Per Foot
	2700 150	1-1/2"	1.72"	200	.324	300	\$3.75
	2700 200	2"	2.22"	200	.420	300	\$5.00
	2700 250	2-1/2"	2.75"	200	.620	300	\$10.09
	2700 300	3"	3.38"	200	.760	300	\$8.11
	2700 400	4"	4.33"	150	1.00	300	\$11.28
	2700 600	6"	6.48"	150	1.60	200/300	\$20.49



SEAL FAST MILL HOSE

MILL DISCHARGE HOSE - SYNTHETIC - SBR LINED

NOT RECOMMENDED FOR USE AS FIRE HOSE WORKING PRESSURE 110PSI

All synthetic, lightweight SBR (rubber) lined general purpose hose designed for open end discharge and wash down. This hose is totally immune to the effects of mildew and requires no drying.

HOSE SIZE	PART NO.	LENGTH	BOWL SIZE	WEIGHT PER LENGTH		LIST PRICE PER FOOT
				UNCOUPLED	COUPLED	
1"	80-100	50 FEET	N/A	7.5	N/A	\$0.72
1-1/2"	80-150	50 FEET	1-3/4"	11	12	\$0.87
1-1/2"	80-150 100	100 FEET	1-3/4"	22	24	\$0.87
2"	80-200	50 FEET	2-3/16"	17	18	\$1.00
2"	80-200 100	100 FEET	2-3/16"	34	36	\$1.00
2-1/2"	80-250	50 FEET	2-13/16"	20	22	\$1.25
2-1/2"	80-250 100	100 FEET	2-13/16"	40	44	\$1.25
3"	80-300	50 FEET	N/A	28	N/A	\$1.64
3"	80-300 100	100 FEET	N/A	56	N/A	\$1.64
4"	80-400	50 FEET	N/A	50	N/A	\$2.28

MILL DISCHARGE HOSE - SYNTHETIC - EPDM LINED

NOT RECOMMENDED FOR USE AS FIRE HOSE WORKING PRESSURE 110PSI

All synthetic, lightweight EPDM Rubber lined general purpose hose designed for open end discharge and wash down. This hose is totally immune to the effects of mildew and requires no drying.

HOSE SIZE	PART NO.	LENGTH	BOWL SIZE	WEIGHT PER LENGTH		LIST PRICE PER FOOT
				UNCOUPLED	COUPLED	
1"	80-132	50 FEET	N/A	7.5	N/A	\$1.00
1-1/2"	80-133	50 FEET	1-3/4"	11	12	\$1.00
1-1/2"	80-133 100	100 FEET	1-3/4"	22	24	\$1.00
2"	80-134	50 FEET	2-3/16"	17	18	\$1.23
2"	80-134 100	100 FEET	2-3/16"	34	36	\$1.23
2-1/2"	80-135	50 FEET	2-13/16"	20	22	\$1.53
2-1/2"	80-135 100	100 FEET	2-13/16"	40	44	\$1.53
3"	80-136	50 FEET	N/A	28	N/A	\$1.87
3"	80-136 100	100 FEET	N/A	56	N/A	\$1.87
4"	80-137	50 FEET	N/A	50	N/A	\$2.74
6"	80-139	50 FEET	N/A	59	N/A	\$4.49

DOUBLE JACKET MILL DISCHARGE HOSE - SYNTHETIC-SBR LINED

NOT RECOMMENDED FOR USE AS FIRE HOSE WORKING PRESSURE 200PSI

All synthetic, lightweight SBR (rubber) lined general purpose hose designed for open end discharge. This hose is totally immune to the effects of mildew and requires no drying.

HOSE SIZE	PART NO.	LENGTH	BOWL SIZE	WEIGHT PER LENGTH		LIST PRICE PER FOOT
				UNCOUPLED	COUPLED	
1-1/2"	80-150DJ	50 FEET	N/A	16.5	N/A	\$1.30
1-1/2"	80-150DJ 100	100 FEET	N/A	33	N/A	\$1.30
2"	80-200DJ	50 FEET	N/A	27.3	N/A	\$1.64
2"	80-200DJ 100	100 FEET	N/A	61.8	N/A	\$1.64
2-1/2"	80-250DJ	50 FEET	N/A	28.5	N/A	\$2.06
2-1/2"	80-250DJ 100	100 FEET	N/A	57	N/A	\$2.06

5% CUTTING CHARGE FOR ANY LENGTH HOSE NOT LISTED





SEAL FAST COUPLED ASSEMBLIES

Mill Hose

(With Aluminum Pinlugs With Brass Nut)

(With Aluminum Cam & Groove Couplings)



WORKING PRESSURE FOR THESE ASSEMBLIES IS 110PSI

Hose ID	Part Number	Description Mill Discharge Hose Assemblies	Clamps Per End	List Price
1-1/2"	80-150AL150S	1-1/2" X 50' Mill Hose W/AL 150S and SS Clamps	1	\$61.32
2"	80-200AL200S	2" X 50' Mill Hose W/AL 200S and SS Clamps	2	\$104.49
2-1/2"	80-250AL250S	2-1/2" X 50' Mill Hose W/AL 250S and SS Clamps	2	\$118.84
3"	80-300AL300S	3" X 50' Mill Hose W/AL 300S and SS Clamps	2	\$137.87
4"	80-400AL400S	4" X 50' Mill Hose W/AL 400S and SS Clamps	3	\$219.58
4"	80-40025AL400S	4" X 25' Mill Hose W/AL 400S and SS Clamps	3	\$139.63
4"	80-400MPXAL400M	4" X 50' Mill Hose Plated KC X Male Shank	3	\$200.11
4"	80-400MPXAL400F	4" X 50' Mill Hose Plated KC X Female Shank	3	\$211.66
1-1/2"	80-150100AL150S	1-1/2" X 100' Mill Hose W/AL 150S and SS Clamps	1	\$113.29
2"	80-200100AL200S	2" X 100' Mill Hose W/AL 200S and SS Clamps	2	\$192.44
2-1/2"	80-250100AL250S	2-1/2" X 100' Mill Hose W/AL 250S and SS Clamps	2	\$212.78
3"	80-300100AL300S	3" X 100' Mill Hose W/AL 300S and SS Clamps	2	\$266.83
1-1/2"	80-150CEAL	1-1/2" X 50' Mill Hose W/C-E AL	1	\$67.20
2"	80-200CEAL	2" X 50' Mill Hose W/C-E AL	2	\$113.21
2-1/2"	80-250CEAL	2-1/2" X 50' Mill Hose W/C-E AL	2	\$94.66
3"	80-300CEAL	3" X 50' Mill Hose W/C-E AL	2	\$157.06
4"	80-400CEAL	4" X 50' Mill Hose W/C-E AL	3	\$210.47
1-1/2"	80-150100CEAL	1-1/2" X 100' Mill Hose W/C-E AL	1	\$119.16
2"	80-200100CEAL	2" X 100' Mill Hose W/C-E AL	2	\$201.15
2-1/2"	80-250100CEAL	2-1/2" X 100' Mill Hose W/C-E AL	2	\$219.82
3"	80-300100CEAL	3" X 100' Mill Hose W/C-E AL	2	\$274.98
1-1/2"	80-15025CEAL	1-1/2" X 25' Mill Hose W/C-E AL	1	\$46.81
2"	80-20025CEAL	2" X 25' Mill Hose W/C-E AL	2	\$69.72
3"	80-30025CEAL	3" X 25' Mill Hose W/C-E AL	2	\$98.58
4"	80-40025CEAL	4" X 25' Mill Hose W/C-E AL	3	\$138.99
2-1/2"	80-25020FNSTCAL	2-1/2" X 20' Mill Hose W/FNST X C AL	2	\$122.28



SEAL FAST COUPLED ASSEMBLIES

Mill Hose

(With Aluminum Pinlugs With Brass Nut)

(With Aluminum Cam & Groove Couplings)



WORKING PRESSURE FOR THESE ASSEMBLIES IS 110PSI

Hose ID	Part Number	Description Mill Hose Coupled SBR Tube	List Price
1-1/2"	80-1502035310	1-1/2" X 50' Mill Hose W/PL NST X 1-3/4"	\$98.74
1-1/2"	80-1502035315	1-1/2" X 50' Mill Hose W/PL NPSH X 1-3/4"	\$98.74
1-1/2"	80-1502035410	1-1/2" X 50' Mill Hose W/RL NST X 1-3/4"	\$98.74
1-1/2"	80-1503035415	1-1/2" X 50' Mill Hose W/RL NPSH X 1-3/4"	\$98.74
1-1/2"	80-1502035410AL	1-1/2" X 50' Mill Hose W/RL NST X 1-3/4"	\$81.95
1-1/2"	80-1502035415AL	1-1/2" X 50' Mill Hose W/RL NPSH X 1-3/4"	\$81.95
1-1/2"	80-1501002035310	1-1/2" X 100' Mill Hose W/PL NST X 1-3/4"	\$150.70
1-1/2"	80-1501002035315	1-1/2" X 100' Mill Hose W/PL NPSH X 1-3/4"	\$150.70
1-1/2"	80-1501002035410	1-1/2" X 100' Mill Hose W/RL NST X 1-3/4"	\$150.70
1-1/2"	80-1501002035415	1-1/2" X 100' Mill Hose W/RL NPSH X 1-3/4"	\$150.70
1-1/2"	80-1501002035410AL	1-1/2" X 100' Mill Hose W/RL NST X 1-3/4"	\$133.91
1-1/2"	80-1501002035415AL	1-1/2" X 100' Mill Hose W/RL NPSH X 1-3/4"	\$133.91
2"	80-2002035421AL	2" X 50' Mill Hose W/RL NST X 2-3/16"	\$117.92
2"	80-2002035418AL	2" X 50' Mill Hose W/RL NPSH X 2-3/16"	\$117.92
2-1/2"	80-2502035355	2-1/2" X 50' Mill Hose W/PL NST 2-13/16	\$209.87
2-1/2"	80-2502035360	2-1/2" X 50' Mill Hose W/PL NPSH 2-13/16	\$209.87
2-1/2"	80-2502035445	2-1/2" X 50' Mill Hose W/RL NST 2-13/16	\$209.87
2-1/2"	80-2502035450	2-1/2" X 50' Mill Hose W/RL NPSH 2-13/16	\$209.87
2-1/2"	80-2502035445AL	2-1/2" X 50' Mill Hose W/RL NST 2-13/16	\$165.89
2-1/2"	80-2502035451AL	2-1/2" X 50' Mill Hose W/RL NPSH 2-13/16	\$165.89
2-1/2"	80-250252035355	2-1/2" X 25' Mill Hose W/PL NST 2-13/16	\$162.90
2-1/2"	80-2501002035355	2-1/2" X 100' Mill Hose W/PL NST 2-13/16	\$303.81
2-1/2"	80-2501002035360	2-1/2" X 100' Mill Hose W/PL NPSH 2-13/16	\$303.81
2-1/2"	80-2501002035445	2-1/2" X 100' Mill Hose W/RL NST 2-13/16	\$303.81
2-1/2"	80-2501002035450	2-1/2" X 100' Mill Hose W/RL NPSH 2-13/16	\$303.81
2-1/2"	80-2501002035445AL	2-1/2" X 100' Mill Hose W/RL NST 2-13/16	\$259.83
2-1/2"	80-2501002035451AL	2-1/2" X 100' Mill Hose W/RL NPSH 2-13/16	\$259.83





SEAL FAST COUPLED ASSEMBLIES

Mill Hose

(With Aluminum Pinlugs With Brass Nut)

(With Aluminum Cam & Groove Couplings)



WORKING PRESSURE FOR THESE ASSEMBLIES IS 110PSI

Hose ID	Part Number	Description Mill Hose Coupled EPDM Tube	Clamps Per End	List Price
1-1/2"	80-133AL150S	1-1/2" X 50' MILL HOSE EPDM TUBE AL150S	1	\$87.30
2"	80-134AL200S	2" X 50' MILL HOSE EPDM TUBE AL200S	2	\$104.49
2-1/2"	80-135AL250S	2-1/2" X 50' MILL HOSE EPDM TUBE AL250S	2	\$118.84
3"	80-136AL300S	3" X 50' MILL HOSE EPDM TUBE AL300S	2	\$148.90
4"	80-137AL400S	4" X 50' MILL HOSE EPDM TUBE AL400S	3	\$219.58
1-1/2"	80-133100AL150S	1-1/2" X 100' MILL HOSE EPDM TUBE AL150S	1	\$165.25
2"	80-134100AL200S	2" X 100' MILL HOSE EPDM TUBE AL200S	2	\$192.44
2-1/2"	80-135100AL250S	2-1/2" X 100' MILL HOSE EPDM TUBE AL250S	2	\$212.78
3"	80-136100AL300S	3" X 100' MILL HOSE EPDM TUBE AL300S	2	\$266.83
1-1/2"	80-133CEAL	1-1/2" X 50' COUPLED W/C-E AL	1	\$93.26
2"	80-134CEAL	2" X 50' COUPLED W/C-E AL	2	\$112.25
2-1/2"	80-135CEAL	2-1/2" X 50' COUPLED W/C-E AL	2	\$123.80
3"	80-136CEAL	3" X 50' COUPLED W/C-E AL	2	\$153.26
4"	80-137CEAL	4" X 50' COUPLED W/C-E AL	3	\$205.43
1-1/2"	80-133100CEAL	1-1/2" X 100' COUPLED W/C-E AL	1	\$171.21
2"	80-134100CEAL	2" X 100' COUPLED W/C-E AL	2	\$200.19
2-1/2"	80-135100CEAL	2-1/2" X 100' COUPLED W/C-E AL	2	\$217.74
3"	80-136100CEAL	3" X 100' COUPLED W/C-E AL	2	\$271.19
1-1/2"	80-1332035310	1-1/2" X 50' MILL HOSE W/PL NST X 1-3/4"		\$124.72
1-1/2"	80-1332035315	1-1/2" X 50' MILL HOSE W/PL NPSH X 1-3/4"		\$124.72
1-1/2"	80-1332035410	1-1/2" X 50' MILL HOSE W/RL NST X 1-3/4"		\$124.72
1-1/2"	80-1332035415	1-1/2" X 50' MILL HOSE W/RL NPSH X 1-3/4"		\$124.72
1-1/2"	80-1332035410AL	1-1/2" X 50' MILL HOSE W/RL NST X 1-3/4"		\$107.93
1-1/2"	80-1332035415AL	1-1/2" X 50' MILL HOSE W/RL NPSH X 1-3/4"		\$107.93



SEAL FAST COUPLED ASSEMBLIES

Mill Hose

(With Aluminum Pinlugs With Brass Nut)



(With Aluminum Cam & Groove Couplings)



WORKING PRESSURE FOR THESE ASSEMBLIES IS 110PSI

Hose ID	Part Number	Description Mill Hose Coupled EPDM Tube	Clamps Per End	List Price
1-1/2"	80-1331002035310	1-1/2" X 100' MILL HOSE W/PL NST X 1-3/4"		\$202.67
1-1/2"	80-1331002035410	1-1/2" X 100' MILL HOSE W/RL NST X 1-3/4"		\$202.67
1-1/2"	80-1331002035315	1-1/2" X 100' MILL HOSE W/PL NPSH X 1-3/4"		\$202.67
2"	80-1342035421AL	2" X 50' MILL HOSE W/RL NST X 2-3/16"		\$148.70
2"	80-1342035424AL	2" X 50' MILL HOSE W/RL NST X 2-5/16"		\$148.70
2"	80-1342012135AL	2" X 50' MILL HOSE W/RL NPSH X 2-5/16"		\$163.34
2-1/2"	80-1352035355	2-1/2" X 50' MILL HOSE W/PL NST X 2-13/16"		\$209.87
2-1/2"	80-1352035360	2-1/2" X 50' MILL HOSE W/PL NPSH X 2-13/16"		\$209.87
2-1/2"	80-1352035445	2-1/2" X 50' MILL HOSE W/RL NST X 2-13/16"		\$209.87
2-1/2"	80-1352035450	2-1/2" X 50' MILL HOSE W/RL NPSH X 2-13/16"		\$209.87
2-1/2"	80-1352035445AL	2-1/2" X 50' MILL HOSE W/RL NST X 2-13/16"		\$165.89
2-1/2"	80-1352035451AL	2-1/2" X 50' MILL HOSE W/RL NPSH X 2-13/16"		\$165.89
DOUBLE JACKET MILL HOSE SBR TUBE				
1-1/2"	80-150DJCEAL	1-1/2" X 50' DOUBLE JACKET MILL W/ C-E AL	1	\$87.26
2"	80-200DJCEAL	2" X 50' DOUBLE JACKET MILL W/ C-E AL	2	\$114.25
2-1/2"	80-250DJCEAL	2-1/2" X 50' DOUBLE JACKET MILL W/ C-E AL	2	\$143.79





SEAL FAST FIRE HOSE

FIRE HOSE -SINGLE JACKET- 300# TEST-WORKING PRESSURE 135PSI 100% POLYESTER-EPDM LINED

Jacket with a high-grade single ply extruded EPDM liner. This hose is totally immune to the effects of mildew. It is designed for emergency fire protection with water pressure not exceeding 135 psi working pressure.

HOSE SIZE	PART NO.	LENGTH	BOWL SIZE	WEIGHT PER LENGTH		LIST PRICE PER FOOT
				UNCOUPLED	COUPLED	
1-1/2"	80-075	50 FEET	1-3/4"	11	12	\$1.32
1-1/2"	80-075 75	75 FEET	1-3/4"	16.5	17.5	\$1.32
1-1/2"	80-075 100	100 FEET	1-3/4"	22	24	\$1.32
2"	80-076	50 FEET	2-5/16"	17	18	\$1.55
2"	80-076 100	100 FEET	2-5/16"	25.5	26.5	\$1.55
2-1/2"	80-077	50 FEET	2-13/16"	25	27	\$1.91
2-1/2"	80-077 75	75 FEET	2-13/16"	37.5	39.5	\$1.91
2-1/2"	80-077 100	100 FEET	2-13/16"	50	54	\$1.91

BRANDING IS 1/2 SERVICE TEST PRESSURE OR 150PSI

FIRE HOSE-SINGLE JACKET 300# TEST-WORKING PRESSURE 135PSI 100% POLYESTER-EPDM LINED - UL LABEL

Jacket with a high grade single ply extruded EPDM liner. This hose is totally immune to the effects of mildew. It is designed for emergency fire protection with water pressure not exceeding 135 psi working pressure. **UL LABEL**

HOSE SIZE	PART NO.	LENGTH	BOWL SIZE	WEIGHT PER LENGTH		LIST PRICE PER FOOT
				UNCOUPLED	COUPLED	
1-1/2"	80-075UL	50 FEET	1-3/4"	11	12	\$1.49
1-1/2"	80-075UL 100	100 FEET	1-3/4"	22	24	\$1.49
2-1/2"	80-077UL	50 FEET	2-13/16"	25	27	\$2.17
2-1/2"	80-077UL 100	100 FEET	2-13/16"	50	54	\$2.17

BRANDING IS 1/2 SERVICE TEST PRESSURE OR 150PSI

UL LABEL

FIRE HOSE -SINGLE JACKET 500# TEST -WORKING PRESSURE 225PSI 100% POLYESTER -EPDM LINED

This lightweight, super-strength hose is recommended for exterior fire protection. All polyester construction will not mildew or decay with age. Recommended 225 psi working pressure.

HOSE SIZE	PART NO.	LENGTH	BOWL SIZE	WEIGHT PER LENGTH		LIST PRICE PER FOOT
				UNCOUPLED	COUPLED	
1-1/2"	80-083	50 FEET	1-3/4"	13	14	\$1.47
1-1/2"	80-083 100	100 FEET	1-3/4"	26	28	\$1.47
2"	80-084	50 FEET	2-5/16"	19	20	\$1.74
2"	80-084 100	100 FEET	2-5/16"	28	40	\$1.74
2-1/2"	80-085	50 FEET	2-13/16"	26	28	\$2.11
2-1/2"	80-085 100	100 FEET	2-13/16"	52	56	\$2.11

BRANDING IS 1/2 SERVICE TEST PRESSURE OR 250PSI

FIRE HOSE - SINGLE JACKET 500# TEST - WORKING PRESSURE 225PSI 100% POLYESTEREPDM LINED - UL LABELED

This lightweight, super-strength hose is recommended for exterior fire protection. All polyester construction will not mildew or decay with age. Recommended 225 psi working pressure.

HOSE SIZE	PART NO.	LENGTH	BOWL SIZE	WEIGHT PER LENGTH		LIST PRICE PER FOOT
				UNCOUPLED	COUPLED	
1-1/2"	80-083UL	50 FEET	1-3/4"	13	14	\$1.79
1-1/2"	80-083UL 100	100 FEET	1-3/4"	26	28	\$1.79
2-1/2"	80-085UL	50 FEET	2-13/16"	26	28	\$2.75
2-1/2"	80-085UL 100	100 FEET	2-13/16"	52	56	\$2.75

BRANDING IS 1/2 SERVICE TEST PRESSURE OR 250PSI

5% CUTTING CHARGE FOR ANY LENGTH HOSE NOT LISTED



SEAL FAST FIRE HOSE

SEAL FAST COUPLED FIRE HOSE ASSEMBLIES

Single Jacket
 UL Label
 300psi Test
 Service Test 150psi
 Working Pressure 135psi



Single Jacket
 300psi Test
 Service Test 150psi
 Working Pressure 135psi

Hose ID	Part Number	Description Single Jacket EPDM Tube 300# Test UL Where Noted	List Price
1-1/2"	80-0752035310	1-1/2" X 50' SJ W/PL NST X 1-3/4"	\$146.71
1-1/2"	80-0752035315	1-1/2" X 50' SJ W/PL NPSH X 1-3/4"	\$146.71
1-1/2"	80-0752035410	1-1/2" X 50' SJ W/RL NST X 1-3/4"	\$146.71
1-1/2"	80-0752035415	1-1/2" X 50' SJ W/RL NPSH X 1-3/4"	\$146.71
1-1/2"	80-0752035410AL	1-1/2" X 50' SJ W/RL NST X 1-3/4" Aluminum	\$129.92
1-1/2"	80-0752035415AL	1-1/2" X 50' SJ W/RL NPSH X 1-3/4" Aluminum	\$129.92
1-1/2"	80-0751002035310	1-1/2" X 100' SJ W/PL NST X 1-3/4"	\$246.64
1-1/2"	80-0751002035315	1-1/2" X 100' SJ W/PL NPSH X 1-3/4"	\$246.64
1-1/2"	80-0751002035410	1-1/2" X 100' SJ W/RL NST X 1-3/4"	\$246.64
1-1/2"	80-0751002035415	1-1/2" X 100' SJ W/RL NPSH X 1-3/4"	\$246.64
1-1/2"	80-0751002035410AL	1-1/2" X 100' SJ W/RL NST X 1-3/4" Aluminum	\$229.85
1-1/2"	80-0751002035415AL	1-1/2" X 100' SJ W/RL NPSH X 1-3/4" Aluminum	\$229.85
1-1/2"	80-075UL2035310	1-1/2" X 50' SJ UL W/PL NST X 1-3/4"	\$146.71
1-1/2"	80-075UL2035410	1-1/2" X 50' SJ UL W/PL NPSH X 1-3/4"	\$146.71
1-1/2"	80-075UL2035410AL	1-1/2" X 50' SJ UL W/RL NST X 1-3/4" Aluminum	\$129.92
1-1/2"	80-075UL1002035410	1-1/2" X 100' SJ UL W/RL NST X 1-3/4"	\$246.64
1-1/2"	80-075UL1002035410AL	1-1/2" X 100' SJ UL W/RL NST X 1-3/4" Aluminum	\$229.85
2"	80-0762035421AL	2" X 50' SJ W/RL NST X 2-3/16" Aluminum	\$179.88
2"	80-0762035418AL	2" X 50' SJ W/RL NPSH X 2-3/16" Aluminum	\$179.88
2"	80-0762035424AL	2" X 50' SJ W/RL NST X 2-5/16" Aluminum	\$179.88
2"	80-0761002035421AL	2" X 100' SJ W/RL NST X 2-3/16" Aluminum	\$299.81
2"	80-0761002035418AL	2" X 100' SJ W/RL NPSH X 2-3/16" Aluminum	\$299.81
2"	80-0761002035424AL	2" X 100' SJ W/RL NPSH X 2-5/16" Aluminum	\$299.81





SEAL FAST FIRE HOSE

SEAL FAST COUPLED FIRE HOSE ASSEMBLIES

Single Jacket
 UL Label
 300psi Test
 Service Test 150psi
 Working Pressure 135psi



Single Jacket
 300psi Test
 Service Test 150psi
 Working Pressure 135psi

Hose ID	Part Number	Description Single Jacket EPDM Tube 300# Test UL Where Noted	List Price
2-1/2"	80-0772035355	2-1/2" X 50' SJ W/PL NST X 2-13/16	\$251.84
2-1/2"	80-0772035360	2-1/2" X 50' SJ W/PL NPSH X 2-13/16	\$251.84
2-1/2"	80-0772035445	2-1/2" X 50' SJ W/RL NST X 2-13/16	\$251.84
2-1/2"	80-0772035450	2-1/2" X 50' SJ W/RL NPSH X 2-13/16	\$251.84
2-1/2"	80-0772035445AL	2-1/2" X 50' SJ W/RL NST X 2-13/16 Aluminum	\$207.87
2-1/2"	80-0772035451AL	2-1/2" X 50' SJ W/RL NPSH X 2-13/16 Aluminum	\$207.87
2-1/2"	80-0771002035355	2-1/2" X 100' SJ W/PL NST X 2-13/16	\$387.75
2-1/2"	80-0771002035360	2-1/2" X 100' SJ W/PL NPSH X 2-13/16	\$387.75
2-1/2"	80-0771002035445	2-1/2" X 100' SJ W/RL NST X 2-13/16	\$387.75
2-1/2"	80-0771002035450	2-1/2" X 100' SJ W/RL NPSH X 2-13/16	\$387.75
2-1/2"	80-0771002035445AL	2-1/2" X 100' SJ W/RL NST X 2-13/16 Aluminum	\$343.78
2-1/2"	80-077UL2035355	2-1/2" X SJ UL W/PL NST X 2-13/16	\$257.83
2-1/2"	80-077UL2035360	2-1/2" X SJ UL W/PL NPSH X 2-13/16	\$257.83
2-1/2"	80-077UL2035445	2-1/2" X SJ UL W/RL NST X 2-13/16	\$257.83
2-1/2"	80-077UL2035445AL	2-1/2" X SJ UL W/RL NST X 2-13/16 Aluminum	\$201.87
2-1/2"	80-077UL1002035355	2-1/2" X 100' SJ UL W/PL NST X 2-13/16	\$399.74
2-1/2"	80-077UL1002035445	2-1/2" X 100' SJ UL W/RL NST X 2-13/16	\$399.74
2-1/2"	80-077UL1002035445AL	2-1/2" X 100' SJ UL W/RL NST X 2-13/16 Aluminum	\$343.78



SEAL FAST FIRE HOSE

SEAL FAST COUPLED FIRE HOSE ASSEMBLIES WORKING PRESSURE FOR THESE ASSEMBLIES IS 225PSI

Hose ID	Part Number	Description Single Jacket EPDM Tube 500# Test UL Where Noted	List Price
1-1/2"	80-0832035310	1-1/2" X 50' SJ W/PL NST 1-3/4"	\$142.71
1-1/2"	80-0832035315	1-1/2" X 50' SJ W/PL NPSH 1-3/4"	\$142.71
1-1/2"	80-0832035410	1-1/2" X 50' SJ W/RL NST 1-3/4"	\$142.71
1-1/2"	80-0832035415	1-1/2" X 50' SJ W/RL NPSH 1-3/4"	\$142.71
1-1/2"	80-0832035410AL	1-1/2" X 50' SJ W/RL NST 1-3/4" Aluminum	\$221.86
1-1/2"	80-0832035415AL	1-1/2" X 50' SJ W/RL NPSH 1-3/4" Aluminum	\$221.86
1-1/2"	80-0831002035310	1-1/2" X 100' SJ W/PL NST 1-3/4"	\$238.65
1-1/2"	80-0831002035315	1-1/2" X 100' SJ W/PL NPSH 1-3/4"	\$238.65
1-1/2"	80-0831002035410	1-1/2" X 100' SJ W/RL NST 1-3/4"	\$238.65
1-1/2"	80-0831002035415	1-1/2" X 100' SJ W/RL NPSH 1-3/4"	\$238.65
1-1/2"	80-0831002035410AL	1-1/2" X 100' SJ W/RL NST 1-3/4" Aluminum	\$221.86
1-1/2"	80-0831002035415AL	1-1/2" X 100' SJ W/RL NPSH 1-3/4" Aluminum	\$221.86
1-1/2"	80-083UL2035310	1-1/2" X 50' SJ W/PL NST 1-3/4"	\$144.71
1-1/2"	80-083UL2035410	1-1/2" X 50' SJ W/RL NST 1-3/4"	\$144.71
1-1/2"	80-083UL2035410AL	1-1/2" X 50' SJ W/RL NST 1-3/4" Aluminum	\$127.92
1-1/2"	80-083UL1002035310	1-1/2" X 100' SJ W/PL NST 1-3/4"	\$242.64
1-1/2"	80-083UL1002035410	1-1/2" X 100' SJ W/RL NST 1-3/4"	\$242.64
1-1/2"	80-083UL1002035410AL	1-1/2" X 100' SJ W/RL NST 1-3/4" Aluminum	\$225.86
2"	80-0842035421AL	2" X 50' SJ W/RL NST 2-3/16" Aluminum	\$171.89
2"	80-0842035424AL	2" X 50' SJ W/RL NST 2-5/16" Aluminum	\$171.89
2"	80-0841002035421AL	2" X 100' SJ W/RL NST 2-3/16" Aluminum	\$332.87
2"	80-0841002035418AL	2" X 100' SJ W/RL NPSH 2-3/16" Aluminum	\$332.87
2"	80-0841002012135AL	2" X 100' SJ W/RL NST 2-5/16" Aluminum	\$332.87
2-1/2"	80-0852035355	2-1/2" X 50' SJ W/PL NST 2-13/16"	\$239.85
2-1/2"	80-0852035360	2-1/2" X 50' SJ W/PL NPSH 2-13/16"	\$239.85
2-1/2"	80-0852035445	2-1/2" X 50' SJ W/RL NST 2-13/16"	\$239.85
2-1/2"	80-0852035450	2-1/2" X 50' SJ W/RL NPSH 2-13/16"	\$239.85
2-1/2"	80-0852035445AL	2-1/2" X 50' SJ W/RL NST 2-13/16" Aluminum	\$195.87
2-1/2"	80-0852035451AL	2-1/2" X 50' SJ W/RL NPSH 2-13/16" Aluminum	\$195.87
2-1/2"	80-0851002035355	2-1/2" X 100' SJ W/PL NST 2-13/16"	\$363.77
2-1/2"	80-0851002035360	2-1/2" X 100' SJ W/PL NPSH 2-13/16"	\$363.77
2-1/2"	80-0851002035445	2-1/2" X 100' SJ W/RL NST 2-13/16"	\$363.77
2-1/2"	80-0851002035450	2-1/2" X 100' SJ W/RL NPSH 2-13/16"	\$363.77
2-1/2"	80-0851002035445AL	2-1/2" X 100' SJ W/RL NST 2-13/16" Aluminum	\$319.80
2-1/2"	80-0851002035451AL	2-1/2" X 100' SJ W/RL NPSH 2-13/16" Aluminum	\$319.80
2-1/2"	80-085UL2035355	2-1/2" X 50' SJ UL W/PL NST 2-13/16"	\$257.83
2-1/2"	80-085UL2035445	2-1/2" X 50' SJ UL W/RL NST 2-13/16"	\$257.83
2-1/2"	80-085UL2035445AL	2-1/2" X 50' SJ UL W/RL NST 2-13/16" Aluminum	\$213.86
2-1/2"	80-085UL1002035355	2-1/2" X 100' SJ UL W/PL NST 2-13/16"	\$399.74
2-1/2"	80-085UL1002035345	2-1/2" X 100' SJ UL W/PL NST 2-13/16"	\$399.74
2-1/2"	80-085UL1002035445AL	2-1/2" X 100' SJ UL W/RL NST 2-13/16" Aluminum	\$355.77





SEAL FAST FIRE HOSE

FIRE HOSE-DOUBLE JACKET- 600# TEST 100% POLYESTER-EPDM LINED WORKING PRESSURE 270PSI

The ultimate in industrial fire protection, this hose is manufactured to exacting municipal requirements. The jackets are woven from the finest high tensile, 100% polyester yarn, with complete filler coverage of both jackets. The compact weave insures flexibility and strength and will provide protection against wear from abrasion. It does not require drying after use and is completely immune to mildew and rot. Recommended 270 psi working pressure.

HOSE SIZE	PART NO.	LENGTH	BOWL SIZE	WEIGHT PER LENGTH		LIST PRICE PER FOOT
				UNCOUPLED	COUPLED	
1-1/2"	80-002	50 FEET	1-15/16"	16.5	17.5	\$2.04
1-1/2"	80-002 100	100 FEET	1-15/16"	33	35	\$2.04
2"	80-003	50 FEET	2-5/16"	19	20	\$2.62
2-1/2"	80-130	50 FEET	3"	28.5	30.5	\$3.08
2-1/2"	80-130 100	100 FEET	3"	57	61	\$3.08

BRANDING IS 1/2 SERVICE TEST PRESSURE OR 300PSI
5% CUTTING CHARGE FOR ANY LENGTH HOSE NOT LISTED

SEAL FAST COUPLED FIRE HOSE ASSEMBLIES



Double Jacket
600psi Test
Service Test 300psi
Working Pressure 270psi

Hose ID	Part Number	Description Double Jacket EPDM Tube 600# Test	Clamps Per End	List Price
1-1/2"	80-0022012110	1-1/2" X 50' DJ W/PL NST 1-15/16"		\$152.70
1-1/2"	80-0022012115	1-1/2" X 50' DJ W/PL NPSH 2"		\$152.70
1-1/2"	80-0022012120	1-1/2" X 50' DJ W/PL NPSH 2"		\$152.70
1-1/2"	80-0022015910	1-1/2" X 50' DJ W/RL NST 1-15/16"		\$152.70
1-1/2"	80-0022015915	1-1/2" X 50' DJ W/RL NPSH 1-15/16"		\$152.70
1-1/2"	80-0022015920	1-1/2" X 50' DJ W/RL NST 2"		\$152.70
1-1/2"	80-0022015925	1-1/2" X 50' DJ W/PL NPSH 2"		\$152.70
1-1/2"	80-0022015910AL	1-1/2" X 50' DJ W/RL NST 1-15/16" Aluminum		\$140.99
1-1/2"	80-0021002012115	1-1/2" X 100' DJ W/PL NST 2"		\$258.63
1-1/2"	80-0021002012120	1-1/2" X 100' DJ W/PL NPSH 2"		\$258.63
1-1/2"	80-0021002015910	1-1/2" X 100' DJ W/RL NST 1-15/16"		\$258.63
1-1/2"	80-0021002015920	1-1/2" X 100' DJ W/RL NST 2"		\$258.63
1-1/2"	80-0021002015925	1-1/2" X 100' DJ W/RL NPSH 2"		\$258.63
1-1/2"	80-0021002015910AL	1-1/2" X 100' DJ W/RL NST 1-15/16" Aluminum		\$241.85
2"	80-0032035424AL	2" X 50' DJ W/RL NST 2-5/16" Aluminum		\$207.87
2"	80-0032012135AL	2" X 50' DJ W/RL NPSH 2-5/16" Aluminum		\$207.87
2"	80-003CEAL	2" X 50' DJ W/C-E AL	2	\$161.18
2-1/2"	80-1302012145	2-1/2" X 50' DJ W/PL NPSH 2-15/16"		\$275.82
2-1/2"	80-1302015953	2-1/2" X 50' DJ W/RL NST 3"		\$275.82
2-1/2"	80-1302012165	2-1/2" X 50' DJ W/PL NST 3"		\$275.82
2-1/2"	80-1302015921AL	2-1/2" X 50' DJ W/RL NST Aluminum		\$235.45
2-1/2"	80-1301002012145	2-1/2" X 100' DJ W/PL NPSH 2-15/16"		\$435.72
2-1/2"	80-1301002015953	2-1/2" X 100' DJ W/RL NST 3"		\$435.72
2-1/2"	80-1301002015921AL	2-1/2" X 100' DJ W/RL NST 3" Aluminum		\$395.35



SEAL FAST FIRE HOSE

FIRE HOSE-DOUBLE JACKET-800# TEST

100% POLYESTER-EPDM LINED WORKING PRESSURE 270PSI

The ultimate in industrial fire protection, this hose is manufactured to exacting municipal requirements. The jackets are woven from the finest high tensile, 100% polyester yarn, with complete filler coverage of both jackets. The compact weave insures flexibility and strength and will provide protection against wear from abrasion. It does not require drying after use and is completely immune to mildew and rot. Recommended 270 psi working pressure.

HOSE SIZE	PART NO.	LENGTH	BOWL SIZE	WEIGHT PER LENGTH		LIST PRICE PER FOOT
				UNCOUPLED	COUPLED	
1-1/2"	80-004	50 FEET	1-15/16"	16.5	17.5	\$2.51
1-1/2"	80-004 100	100 FEET	1-15/16"	33	35	\$2.51
2-1/2"	80-131	50 FEET	3"	28.5	30.5	\$4.30
2-1/2"	80-131 100	100 FEET	3"	57	61	\$4.30

BRANDING IS 1/2 SERVICE TEST PRESSURE OR 400PSI
5% CUTTING CHARGE FOR ANY LENGTH HOSE NOT LISTED

SEAL FAST COUPLED FIRE HOSE ASSEMBLIES



Double Jacket 800psi Test
Service Test 400psi
Working Pressure 270psi

Hose ID	Part Number	Description Double Jacket EPDM Tube 800# Test	List Price
1-1/2"	80-0042012110	1-1/2" X 50' DJ W/PL NST X 1-15/16"	\$212.66
1-1/2"	80-0042012115	1-1/2" X 50' DJ W/PL NST X 2"	\$212.66
1-1/2"	80-0042012120	1-1/2" X 50' DJ W/PL NPSH X 2"	\$212.66
1-1/2"	80-0042015910	1-1/2" X 50' DJ W/RL NST 1-15/16"	\$212.66
1-1/2"	80-0042015915	1-1/2" X 50' DJ W/RL NPSH X 1-15/16"	\$212.66
1-1/2"	80-0042015920	1-1/2" X 50' DJ W/RL NST X 2"	\$212.66
1-1/2"	80-0042015925	1-1/2" X 50' DJ W/RL NPSH X 2"	\$212.66
1-1/2"	80-0042015910AL	1-1/2" X 50' DJ W/RL NST X 1-15/16" Aluminum	\$195.87
1-1/2"	80-0041002012110	1-1/2" X 100' DJ W/PL NST X 2"	\$378.56
1-1/2"	80-0041002012120	1-1/2" X 100' DJ W/PL NPSH X 2"	\$378.56
1-1/2"	80-0041002015920	1-1/2" X 100' DJ W/RL NST X 2"	\$378.56
1-1/2"	80-0041002015925	1-1/2" X 100' DJ W/RL NPSH X 2"	\$378.56
1-1/2"	80-0041002015910AL	1-1/2" X 100' DJ W/RL NST X 1-15/16" Aluminum	\$361.77
2-1/2"	80-1312012165	2-1/2" X 50' DJ W/PL NST X 3-1/8"	\$387.75
2-1/2"	80-1312015960	2-1/2" X 50' DJ W/RL NPSH X 3-1/8"	\$387.75
2-1/2"	80-1312015953	2-1/2" X 50' DJ W/RL NST X 3"	\$387.75
2-1/2"	80-1312015921AL	2-1/2" X 50' DJ W/RL NST X 3" Aluminum	\$347.38
2-1/2"	80-1311002012155	2-1/2" X 100' DJ W/PL NST X 3-1/8"	\$659.58
2-1/2"	80-1311002012160	2-1/2" X 100' DJ W/PL NPSH X 3-1/8"	\$659.58
2-1/2"	80-1311002015953	2-1/2" X 100' DJ W/RL NST X 3"	\$659.58
2-1/2"	80-1311002015921AL	2-1/2" X 100' DJ W/RL NST X 3" Aluminum	\$619.20



SEAL FAST FIRE HOSE

FIRE HOSE - SINGLE JACKET - 500# TEST - RED POLYMERIC COATING EPDM LINING WORKING PRESSURE 135PSI



This hose is 100% polyester with a outer red polymeric coating having high ozone and abrasion resistance. Wide range of application including power plants, steel plants, mines and all other types of industry needing high visibility and maintenance free hose. Recommended 135 psi working pressure.

HOSE SIZE	PART NO.	LENGTH	BOWL SIZE	WEIGHT PER LENGTH		LIST PRICE PER FOOT
				UNCOUPLED	COUPLED	
1-1/2"	NOVADURA150	50 FEET	1-3/4"	10.5	11.5	\$2.43
1-1/2"	NOVADURA150 100	100 FEET	1-3/4"	21	23	\$2.43
2-1/2"	NOVADURA250	50 FEET	2-13/16"	19.5	21.5	\$3.53
2-1/2"	NOVADURA250 100	100 FEET	2-13/16"	39	43	\$3.53

BRANDING 1/2 SERVICE TEST PRESSURE OR 250PSI
5% CUTTING CHARGE FOR ANY LENGTH HOSE NOT LISTED

SEAL FAST COUPLED ASSEMBLIES



Single Jacket
500# Test
Service Test 250#
Working Pressure 135psi

Hose ID	Part Number	Description Single Jacket Red Coated 500# Test	List Price
1-1/2"	N1502035310	1-1/2" X 50' SJ W/PL NST X 1-3/4"	\$176.69
1-1/2"	N1502035315	1-1/2" X 50' SJ W/PL NPSH X 1-3/4"	\$176.69
1-1/2"	N1502035410	1-1/2" X 50' SJ W/RL NST X 1-3/4"	\$176.69
1-1/2"	N1502035415	1-1/2" X 50' SJ W/RL NPSH X 1-3/4"	\$176.69
1-1/2"	N1502035410AL	1-1/2" X 50' SJ W/RL NST X 1-3/4" Aluminum	\$159.90
1-1/2"	N1502035415AL	1-1/2" X 50' SJ W/RL NPSH X 1-3/4" Aluminum	\$159.90
1-1/2"	N1501002035310	1-1/2" X 100' SJ W/PL NST X 1-3/4"	\$306.60
1-1/2"	N1501002035315	1-1/2" X 100' SJ W/PL NPSH X 1-3/4"	\$306.60
1-1/2"	N1501002035410	1-1/2" X 100' SJ W/RL NST X 1-3/4"	\$306.60
1-1/2"	N1501002035415	1-1/2" X 100' SJ W/RL NPSH X 1-3/4"	\$306.60
1-1/2"	N1501002035410AL	1-1/2" X 100' SJ W/RL NST X 1-3/4" Aluminum	\$289.81
1-1/2"	N1501002035415AL	1-1/2" X 100' SJ W/RL NPSH X 1-3/4" Aluminum	\$289.81
2-1/2"	N2502035355	2-1/2" X 50' SJ W/PL NST X 2-13/16"	\$317.80
2-1/2"	N2502035360	2-1/2" X 50' SJ W/PL NPSH X 2-13/16"	\$317.80
2-1/2"	N2502035445	2-1/2" X 50' SJ W/RL NST X 2-13/16"	\$317.80
2-1/2"	N2502035450	2-1/2" X 50' SJ W/RL NPSH X 2-13/16"	\$317.80
2-1/2"	N2502035445AL	2-1/2" X 50' SJ W/RL NST X 2-13/16" Aluminum	\$273.82
2-1/2"	N2502035451AL	2-1/2" X 50' SJ W/RL NPSH X 2-13/16" Aluminum	\$273.82
2-1/2"	N2501002035355	2-1/2" X 100' SJ W/PL NST X 2-13/16"	\$519.67
2-1/2"	N2501002035360	2-1/2" X 100' SJ W/PL NPSH X 2-13/16"	\$519.67
2-1/2"	N2501002035445	2-1/2" X 100' SJ W/RL NST X 2-13/16"	\$519.67
2-1/2"	N2501002035450	2-1/2" X 100' SJ W/RL NPSH X 2-13/16"	\$519.67
2-1/2"	N2501002035445AL	2-1/2" X 100' SJ W/RL NST X 2-13/16" Aluminum	\$475.70
2-1/2"	N2501002035451AL	2-1/2" X 100' SJ W/RL NPSH X 2-13/16" Aluminum	\$475.70





SEAL FAST FIRE HOSE

FIRE HOSE - SINGLE JACKET - 500# TEST - YELLOW POLYMERIC COAT - EPDM LINING-WORKING PRESSURE 135PSI

This hose is 100% polyester with a outer yellow polymeric coating having high ozone and abrasion resistance. A wide range of applications including power plants, steel plants, mines and all other types of industry needing high visibility and maintenance free hose.



HOSE SIZE	PART NO.	LENGTH	BOWL SIZE	WEIGHT PER LENGTH		LIST PRICE PER FOOT
				UNCOUPLED	COUPLED	
1-1/2"	NOVADURA150Y	50 FEET	1-3/4"	10.5	11.5	\$2.43
1-1/2"	NOVADURA150Y 100	100 FEET	1-3/4"	21	23	\$2.43
2-1/2"	NOVADURA250Y	50 FEET	2-13/16"	19.5	21.5	\$3.53
2-1/2"	NOVADURA250Y 100	100 FEET	2-13/16"	39	43	\$3.53

BRANDING 1/2 SERVICE TEST PRESSURE OR 250PSI
5% CUTTING CHARGE FOR ANY LENGTH HOSE NOT LISTED

Single Jacket
500# Test
Working Pressure 135psi

SEAL FAST COUPLED ASSEMBLIES

Hose ID	Part Number	Description Single Jacket Yellow Coated 500# Test	List Price
1-1/2"	NY1502035310	1-1/2" X 50' SJ W/PL NST X 1-3/4"	\$176.69
1-1/2"	NY1502035315	1-1/2" X 50' SJ W/PL NPSH X 1-3/4"	\$176.69
1-1/2"	NY1502035410	1-1/2" X 50' SJ W/RL NST X 1-3/4"	\$176.69
1-1/2"	NY1502035415	1-1/2" X 50' SJ W/RL NPSH X 1-3/4"	\$176.69
1-1/2"	NY1502035410AL	1-1/2" X 50' SJ W/RL NST X 1-3/4"	\$159.90
1-1/2"	NY1502035415AL	1-1/2" X 50' SJ W/RL NPSH X 1-3/4"	\$159.90
1-1/2"	NY1501002035310	1-1/2" X 100' SJ W/PL NST X 1-3/4"	\$306.60
1-1/2"	NY1501002035315	1-1/2" X 100' SJ W/PL NPSH X 1-3/4"	\$306.60
1-1/2"	NY1501002035410	1-1/2" X 100' SJ W/RL NST X 1-3/4"	\$306.60
1-1/2"	NY1501002035415	1-1/2" X 100' SJ W/RL NPSH X 1-3/4"	\$306.60
1-1/2"	NY1501002035410AL	1-1/2" X 100' SJ W/RL NST X 1-3/4"	\$289.81
1-1/2"	NY1501002035415AL	1-1/2" X 100' SJ W/RL NPSH X 1-3/4"	\$289.81
2-1/2"	NY2502035355	2-1/2" X 50' SJ W/PL NST X 2-13/16"	\$317.80
2-1/2"	NY2502035360	2-1/2" X 50' SJ W/PL NPSH X 2-13/16"	\$317.80
2-1/2"	NY2502035445	2-1/2" X 50' SJ W/RL NST X 2-13/16"	\$317.80
2-1/2"	NY2502035450	2-1/2" X 50' SJ W/RL NPSH X 2-13/16"	\$317.80
2-1/2"	NY2502035445AL	2-1/2" X 50' SJ W/RL NST X 2-13/16"	\$273.82
2-1/2"	NY2502035451AL	2-1/2" X 50' SJ W/RL NPSH X 2-13/16"	\$273.82
2-1/2"	NY2501002035355	2-1/2" X 100' SJ W/PL NST X 2-13/16"	\$519.67
2-1/2"	NY2501002035360	2-1/2" X 100' SJ W/PL NPSH X 2-13/16"	\$519.67
2-1/2"	NY2501002035445	2-1/2" X 100' SJ W/RL NST X 2-13/16"	\$519.67
2-1/2"	NY2501002035450	2-1/2" X 100' SJ W/RL NPSH X 2-13/16"	\$519.67
2-1/2"	NY2501002035445AL	2-1/2" X 100' SJ W/RL NST X 2-13/16"	\$475.70
2-1/2"	NY2501002035451AL	2-1/2" X 100' SJ W/RL NPSH X 2-13/16"	\$475.70

FORESTRY HOSE - 100% POLYESTER - 500# TEST YELLOW COVER

Forestry hose light weight 100% polyester in oxford weave. Lining is patented lamination of tropicalized rubber. This hose is ideal to combat forest fires with controlled water percolation and resistant to abrasion and heat. Cover is yellow for high visibility. Recommended 125 psi working pressure.

HOSE SIZE	PART NO.	LENGTH	BOWL SIZE	WEIGHT PER LENGTH		LIST PRICE PER FOOT
				UNCOUPLED	COUPLED	
1-1/2"	FORESTRY150	50 FEET	1-3/4"	5	6	\$3.04
1-1/2"	FORESTRY150 100	100 FEET	1-3/4"	11	12	\$3.04

BRANDING 1/2 SERVICE TEST PRESSURE 250PSI





NITRIL-PVC HOSE

NITRILE COVERED FIRE HOSE - PERMALINE 100% SYNTHETIC - RED-WORKING PRESSURE 225PSI



This covered hose is a premium quality, abrasion resistant, chemical resistant, lightweight industrial fire hose. The one-piece cover/lining totally encompasses the synthetic reinforcement providing an industrial fire hose that is easy to use, clean and maintain. This hose is totally immune to mildew and resists the effects of most chemicals. Recommended 225 psi working pressure. **RED COVER**

HOSE SIZE	PART NO.	LENGTH	BOWL SIZE	WEIGHT PER LENGTH		LIST PRICE PER FOOT
				UNCOUPLED	COUPLED	
1-1/2"	PERMALINE 150	50 FEET	1-3/4"	10.5	11.5	\$2.57
1-1/2"	PERMALINE 150 100	100 FEET	1-3/4"	21	23	\$2.57
2-1/2"	PERMALINE 250	50 FEET	2-13/16"	19.5	21.5	\$3.89
2-1/2"	PERMALINE 250 100	100 FEET	2-13/16"	39	43	\$3.89

BRANDING IS 1/2 SERVICE TEST PRESSURE OR 250PSI
5% CUTTING CHARGE FOR ANY LENGTH HOSE NOT LISTED

SEAL FAST COUPLED FIRE HOSE ASSEMBLIES

500# Test
Service Test 250#
Working Pressure 225psi

NITRILE COVERED

Hose ID	Part Number	Description Nitril Covered 500# Test	List Price
1-1/2"	P1502035310	1-1/2" X 50' SJ W/PL NST X 1-3/4"	\$250.64
1-1/2"	P1502035315	1-1/2" X 50' SJ W/PL NPSH X 1-3/4"	\$250.64
1-1/2"	P1502035410	1-1/2" X 50' SJ W/RL NST X 1-3/4"	\$250.64
1-1/2"	P1502035415	1-1/2" X 50' SJ W/RL NPSH X 1-3/4"	\$250.64
1-1/2"	P1502035410AL	1-1/2" X 50'SJ W/RL NST X 1-3/4" Aluminum	\$233.85
1-1/2"	P1502035415AL	1-1/2" X 50'SJ W/RL NPSH X 1-3/4" Aluminum	\$233.85
1-1/2"	P1501002035310	1-1/2" X 100' SJ W/PL NST X 1-3/4"	\$454.51
1-1/2"	P1501002035315	1-1/2" X 100' SJ W/PL NPSH X 1-3/4"	\$454.51
1-1/2"	P1501002035410	1-1/2" X 100' SJ W/RL NST X 1-3/4"	\$454.51
1-1/2"	P1501002035415	1-1/2" X 100' SJ W/RL NPSH X 1-3/4"	\$454.51
1-1/2"	P1501002035410AL	1-1/2" X 100' SJ W/RL NST X 1-3/4" Aluminum	\$437.72
1-1/2"	P1501002035415AL	1-1/2" X 100' SJ W/RL NPSH X 1-3/4" Aluminum	\$437.72
2-1/2"	P2502035355	2-1/2" X 50' SJ W/PL NST X 2-13/16	\$423.73
2-1/2"	P2502035360	2-1/2" X 50' SJ W/PL NPSH X 2-13/16	\$423.73
2-1/2"	P2502035445	2-1/2" X 50' SJ W/RL NST X 2-13/16	\$423.73
2-1/2"	P2502035450	2-1/2" X 50' SJ W/RL NPSH X 2-13/16	\$423.73
2-1/2"	P2502035445AL	2-1/2" X 50' SJ W/RL NST X 2-13/16 Aluminum	\$383.35
2-1/2"	P2502035451AL	2-1/2" X 50' SJ W/RL NPSH X 2-13/16 Aluminum	\$383.35
2-1/2"	P2501002035355	2-1/2" X 100'SJ W/PL NST X 2-13/16	\$731.53
2-1/2"	P2501002035360	2-1/2" X 100'SJ W/PL NPSH X 2-13/16	\$731.53
2-1/2"	P2501002035445	2-1/2" X 100'SJ W/RL NST X 2-13/16	\$731.53
2-1/2"	P2501002035450	2-1/2" X 100'SJ W/RL NPSH X 2-13/16	\$731.53
2-1/2"	P2501002035445AL	2-1/2" X 100'SJ W/RL NST X 2-13/16 Aluminum	\$691.16
2-1/2"	P2501002035451AL	2-1/2" X 100'SJ W/RL NPSH X 2-13/16 Aluminum	\$691.16



FIRE HOSE FITTINGS AND ACCESSORIES

 Single Jacket Brass Pin Lug Brass 20353		
Part #	Size	List Price
2035310	1-1/2" NST x 1-3/4"	\$43.36
2035315	1-1/2" NPSH x 1-3/4"	\$43.36
2035355	2-1/2" NST x 2-13/16"	\$107.55
2035360	2-1/2" NPSH x 2-13/16"	\$107.55

 Single Jacket Brass Rocker Lug Brass 20354		
Part #	Size	List Price
2035410	1-1/2" NST x 1-3/4"	\$43.36
2035415	1-1/2" NPSH x 1-3/4"	\$43.36
2035445	2-1/2" NST x 2-13/16"	\$107.55
2035450	2-1/2" NPSH x 2-13/16"	\$107.55

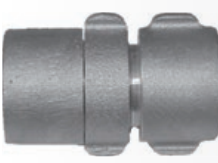
 Double Jacket Brass Rocker Lug Brass 20159		
Part #	Size	List Price
2015910	1-1/2" NST x 1-15/16"	\$43.36
2015915	1-1/2" NPSH x 1-15/16"	\$43.36
2015953	2-1/2" NST x 3"	\$107.55

 Double Jacket Brass Pin Lug Brass 20121		
Part #	Size	List Price
2012110	1-1/2" NST x 1-15/16"	\$43.36
2012165	2-1/2" NST x 3"	\$107.55

 Brass Expansion Rings 22129		
Part #	Size	List Price
2212915	1-1/2" x 3/4"	\$3.30
2212920	1-1/2" x 1"	\$3.47
2212925	1-1/2" x 1-1/4"	\$3.68
2212930	2" x 1"	\$3.96
2212935	2" x 1-1/4"	\$4.75
2212940	2-7/16" x 1-1/4"	\$5.83
2212945	2-7/16" x 1-1/2"	\$6.40







FIRE HOSE FITTINGS AND ACCESSORIES

 <p>Female x Female Swivel 100 psi working pressure max 19115</p>		
1911526AL	1-1/2" FNST x 1-1/2" FNST	\$17.74
1911527AL	1-1/2" FNPSH X 1-1/2" FNST	\$17.74
1911561AL	2-1/2" FNST X 2-1/2" FNST	\$33.40
1911562AL	2-1/2" FNPSH X 2-1/2" FNST	\$33.40

 <p>Aluminum Couplings Hard Coat Female x Male Swivel 100 psi wpm 19215</p>		
1921522AL	1-1/2" FNST X 1-1/2" MNST	\$17.74
1921523AL	1-1/2" FNST X 1-1/2" MNPT	\$17.55
1921572AL	2-1/2" FNST X 2-1/2" MNST	\$38.49
1921573AL	2-1/2" FNST X 2-1/2" MNPT	\$38.11

 <p>Aluminum Rocker Lug Single Jacket Double Jacket 20354 20159 20121</p>		
2035410AL	1-1/2" NST X 1-3/4"	\$27.81
2035415AL	1-1/2" NPSH X 1-3/4"	\$27.81
2015910AL	1-1/2" NST X 1-15/16"	\$31.92
2017510AL	1-3/4" X 1-1/2" NST X 2-1/6"	\$44.62
2035418AL	2" NPSH X 2-3/16"	\$40.91
2035421AL	2" NST X 2-3/16"	\$40.91
2035424AL	2" NST X 2-5/16"	\$40.91
2035427AL	1-1/2" NST X 1-3/4 FORESTRY	\$44.62
2035435AL	2" NPSH X 2-5/16"	\$55.49
2035445AL	2-1/2" NST X 2-13/16"	\$60.15
2035451AL	2-1/2" NPSH X 2-13/16"	\$60.15
2015921AL	2-1/2" NST X 3"	\$63.00

 <p>Swivel Gaskets SBR</p>					
G12011	1-1/2" NPSH Swivel	1-17/32"	2-1/16"	1/8"	\$0.81
G12015	1-1/2" NST Swivel	1-37/64"	2-1/16"	1/8"	\$0.81
G12038	2" Swivel	2-1/16"	2-5/8"	1/8"	\$1.04
G12042	2-1/2" NPSH Swivel	2-7/16"	3-3/16"	3/16"	\$1.40
G12041	2-1/2" NST Swivel	2-1/2"	3-7/32"	3/16"	\$1.40

 <p>Tail Gaskets SBR</p>					
G12020	1-1/2" SJ Tail	1-9/16"	1-29/32"	3/16"	\$0.81
G12016	1-1/2" DJ Tail	1-5/8"	2-1/32"	3/16"	\$0.81
G12036	2" Tail	2-3/32"	2-5/8"	3/16"	\$1.04
G12046	2-1/2" SJ Tail	2-9/16"	3-1/32"	1/4"	\$1.40
G12044	2-1/2" DJ Tail	2-5/8"	3-5/32"	1/4"	\$1.40

P



FIRE HOSE FITTINGS AND ACCESSORIES



Female x Male Reducer (Brass)
100 psi working pressure max
19130

Part #	Size	List Price
1913009	1-1/2" F NST x 3/4" M GHT	\$7.87
1913011	1-1/2" F NST x 1" M NPT	\$9.19
1913013	1-1/2" F NST x 1" M NPSH	\$8.21
1913036	2-1/2" F NST x 3/4" M NPT	\$13.94
1913037	2-1/2" F NST x 3/4" M GHT	\$14.25
1913039	2-1/2" F NST x 1" M NPSH	\$13.11
1913040	2-1/2" F NST x 1" M NPT	\$13.11
1913045	2-1/2" F NPT x 1-1/2" M NST	\$17.55
1913050	2-1/2" F NPSH x 1-1/2" M NPT	\$15.57
1913053	2-1/2" F NPSH x 1-1/2" M NST	\$14.72
1913055	2-1/2" F NST x 1-1/2" M NPT	\$13.98
1913057	2-1/2" F NST x 1-1/2" M NST	\$14.08
1913060	2-1/2" F NST x 2" M NPT	\$18.36
1913062	2-1/2" F NST x 2" M NPSH	\$15.28
1913065	2-1/2" F NST x 2" M NST	\$17.51
1913067	2-1/2" F NPSH x 2" M NPT	\$16.89
1913069	2-1/2" F NPSH x 2" M NST	\$22.26
1913071	2-1/2" F NST x 1-1/2" M NPSH	\$13.98
1913075	3" F NPT x 2-1/2" M NST	\$21.70
New Orleans Sewage Thread		
1913077	2-1/2" F NOST x 1-1/2" MNPT	\$22.55
1913078	2-1/2" F NOST x 2" MNPT	\$22.06



Female x Male Hex Nipple (Brass)
100 psi working pressure max
24155

Part #	Size	List Price
2415517	3/4" F GHT x 3/4" M NPT	\$2.94
2415518	3/4" F GHT x 1" M NPT	\$6.42
2415520	1" F NPT x 3/4" M GHT	\$5.04
2415523	1-1/2" F NST x 1" M NPT	\$14.08
2415525	1-1/2" F NPT x 1-1/2" M NST	\$8.60
2415530	1-1/2" F NPSH x 1-1/2" M NPSH	\$11.23
2415535	1-1/2" F NST x 1-1/2" M NPT	\$8.15
2415540	2-1/2" F NPT x 1-1/2" M NST	\$17.98
2415545	2-1/2" F NST x 1-1/2" M NST	\$15.38
2415548	2-1/2" F NST x 2" M NPT	\$19.25
241555	1-1/2" F NPT x 1" M NPT	\$15.08
2415550	2-1/2" F NPSH x 2-1/2" M NPT	\$18.02
2415555	2-1/2" F NST x 2-1/2" M NST	\$25.94
2415560	2-1/2" F NST x 2-1/2" M NPT	\$22.98
2415570	2-1/2" F NPT x 2-1/2" M NST	\$22.55
2415571	3" F NPT x 2-1/2" M NST	\$29.92
2415580	2-1/2" F NPSH x 2-1/2" M NST	\$22.17
2415590	4" F NST x 2-1/2" M NST	\$63.98
2415593	4-1/2" F NST x 2-1/2" M NST	\$75.57



Female x Male - Pin Lug (Brass)
100 psi working pressure max
19140

Part #	Size	List Price
1914020	1-1/2" F NST x 1-1/2" M NPT	\$9.72
1914025	1-1/2" F NPSH x 1-1/2" M NST	\$10.75
1914040	2-1/2" F NST x 2-1/2" M NPT	\$16.89
1914050	2-1/2" F NPSH x 2-1/2" M NST	\$16.70



Double Male Hex Nipple (Brass)
100 psi working pressure max
24146

Part #	Size	List Price
2414620	1-1/2" M NST x 1-1/2" M NST	\$8.40
2414625	1-1/2" M NST x 1-1/2" M NPT	\$9.91
2414630	1-1/2" M NPT x 1-1/2" M NPSH	\$7.64
2414635	2-1/2" M NPT x 1-1/2" M NST	\$18.21
2414640	2-1/2" M NST x 1-1/2" M NPT	\$18.40
2414650	2-1/2" M NST x 1-1/2" M NST	\$19.62
2414655	2-1/2" M NST x 2" M NST	\$17.26
2414660	2-1/2" M NPSH x 2" M NST	\$18.66
2414665	2-1/2" M NST x 2" M NPT	\$18.96
2414673	2-1/2" M NST x 2-1/2" M NPT	\$20.92
2414675	2-1/2" M NST x 2-1/2" M NST	\$20.09
2414682	3" M NPT x 2-1/2" M NST	\$31.43
2414690	4" M NST x 4" M NPT	\$57.17
2414692	4-1/2" M NST x 4" M NPT	\$69.64



Aluminum Couplings Hard Coat
100 psi working pressure max
14146 Male x Male

Part #	Size	List Price
2414622AL	1-1/2" MNST x 1-1/2" MNST	\$15.66
2414623AL	1-1/2" MNST x 1-1/2" MNPT	\$15.66
2414624AL	1-1/2" MNST x 1-1/2" MNPSH	\$15.66
2414677AL	2-1/2" MNST x 2-1/2" MNST	\$19.72
2414678AL	2-1/2" MNST x 2-1/2" MNPT	\$19.72





FIRE HOSE FITTINGS AND ACCESSORIES

Double Male Pin Lug (Brass)
100 psi working pressure max
19114

Part #	Size	List Price
1911421	1-1/2" M NPSH x 1-1/2" M NPSH R/L	\$16.89
1911450	2-1/2" M NPSH X 2-1/2" M NPT	\$21.98
1911455	2-1/2" M NPSH X 2-1/2" M NST	\$21.04

Double Female Swivel (Brass)
100 psi working pressure max
19115 Brass Swivels

Part #	Size	List Price
1911520	1-1/2" FNST x 1-1/2" FNST	\$14.06
1911525	1-1/2" FNPT x 1-1/2" FNST	\$15.85
1911530	1-1/2" FNPSH x 1-1/2" FNST	\$15.94
1911531	1-1/2" FNPSH x 1-1/2" FNPSH	\$16.70
1911535	1-1/2" FNPT x 1-1/2" FNPSH	\$16.70
1911545	2-1/2" FNST x 1-1/2" FNPT	\$23.96
1911555	2-1/2" FNPT x 2-1/2" FNST	\$48.64
1911560	2-1/2" FNST x 2-1/2" FNST	\$43.77

Female x Female - Hex (Brass)
100 psi working pressure max
24156

Part #	Size	List Price
2415620	1-1/2" F NST x 1-1/2" F NST	\$9.72
2415625	1-1/2" F NST x 1-1/2" F NPT	\$8.68
2415660	2-1/2" F NPT x 2-1/2" F NST	\$20.96
2415665	2-1/2" F NST x 2-1/2" F NST	\$19.25

Cap & Chain
Not intended for pressure
27126 Brass Cap

Part #	Size	List Price
2712630	1-1/2" NST Brass	\$9.62
2712640	1-1/2" NPSH Brass	\$9.91
2712650	2-1/2" NST Brass	\$15.98
2712660	2-1/2" NPSH Brass	\$16.36
2712662	4" NST Brass	\$47.51
2712665	4-1/2" NST Brass	\$47.51
2712630AL	1-1/2" NST HARD COAT ALUMINUM	\$15.00
2500	2-1/2" NST (Plastic)	\$10.91

Hex Female x Male Adapter (Brass)
100 psi working pressure max
25216

Part #	Size	List Price
2521632	1-1/2" F NST x 2" M NST	\$13.19
2521640	1-1/2" F NST x 2-1/2" M NST	\$18.58
2521642	1-1/2" F NPT x 2-1/2" M NST	\$18.58
2521650	2" F NPT x 2-1/2" M NST	\$25.30
2521677	2-1/2" F NST x 3" M NPT	\$29.60
2521680	4" F NPT x 4-1/2" M NST	\$87.25

Swivel Adapters - Pin Lug (Brass)
100 psi working pressure max
19215 Brass Swivels

Part #	Size	List Price
1921520	1-1/2" F NST x 1-1/2" M NPT	\$16.94
1921547	1-1/2" F NPSH X 1-1/2" M NPT	\$22.06
1921550	2-1/2" F NST x 2" M NPT	\$37.48
1921570	2-1/2" F NST x 2-1/2" M NPT	\$33.87
1921580	2-1/2" F NST x 3" M NPT"	\$50.08

Plug and Chain (Brass)
Not intended for pressure
2712725 NST

Part #	Size	List Price
2712725	2-1/2" NST (Plug)	\$26.60

P



FIRE HOSE FITTINGS AND ACCESSORIES



Plain Wye (Brass)
 Divide One Stream Into Two
 Brass w/ Red Body Paint
 100 psi
14106

Part #	Size	List Price
1410610	1-1/2" NST x 1-1/2" NST x 1-1/2" NST	\$100.94
1410612	2-1/2" NST x 1-1/2" NST x 1-1/2" NST	\$148.79
1410615	2-1/2" NST x 2-1/2" NST x 2-1/2" NST	\$155.66



Plain Wye (Aluminum Hardcoat)
 Weight 4.3 lbs.
587

Description	List Price
2-1/2" Female NST Inlet x (2) 2-1/2" Male NST Outlets	\$434.53

Maximum working pressure is 200psi



Angle Hose Valve (Brass)
 Female x Male
 150 psi water
28157

Part #	Size	List Price
2815725	1-1/2" F NPT x 1-1/2" M NST	\$86.23
2815735	1-1/2" F NPT x 1-1/2" M NPSH	\$86.23
2815750	2-1/2" F NPT x 2-1/2" M NST	\$225.09



Angle Hose Valve (Brass)
 Female x Female
 150 psi water
28158

Part #	Size	List Price
2815825	1-1/2" F NPT x 1-1/2" F NPT	\$86.23
2815855	2-1/2" F NPT x 2-1/2" F NPT	\$225.09



Siamese Clapper Valve (Aluminum Hardcoat)
 Weight 6.4 lbs.
585

Description	List Price
(2) 2-1/2" Female NST Swivel Inlets x 2-1/2" Male NST Outlet. Optional Drain Valve.	\$650.94

Maximum working pressure is 200 psi



Non-Rising Stem 200# Gate Valve
 Complete with Cap and Chain
 Cast Brass
 Note: Not recommended for Wet Standpipe system; use part number 28157 for this application.
2928150

Part #	Size	List Price
2928150	2-1/2" F NPT x 2-1/2" M NST	\$256.32

P



FIRE HOSE FITTINGS AND ACCESSORIES

Plastic Adapters and Caps



Part #	Size	List Price
1515	1-1/2" F NPSH x 1-1/2" M NST PLASTIC	\$15.57
2515	2-1/2" F NST x 1-1/2" M NPSH PLASTIC	\$20.28



Part #	Size	List Price
1500C	1-1/2" Thread Cap NST	\$10.94
2000C	2" Thread Cap NPSH	\$13.96
2500C	2-1/2" Thread Cap NST	\$10.91
3000C	3" Thread Cap NST	\$20.47

Sidewalk Escutcheon Plate

(use with 3120110)



3420920

Size	List Price
4"	\$25.94

"Y" Type "Short Body" Single Clapper



UL Listed
FM Approved
ULC
Auto-Sprkr

3120110
NPT x NST x NST

Size	List Price
4" x 2-1/2" x 2-1/2"	\$131.47

P



FIRE HOSE FITTINGS AND ACCESSORIES

 <p>Brass Nozzle 100 psi 10464 Satin Brass</p>		
Part #	Size	List Price
1046432	1-1/2" NPSH non-UL	\$47.92
1046433	1-1/2" NST non-UL	\$47.92

 <p>Industrial Fog Nozzle Shut Off Straight Stream Fog 100 psi 10464 Satin Brass Class A & B Fires</p>		
Part #	Size	List Price
1046420	1" NPSH	\$42.45
1046421	1" NST	\$29.71
1046430	1-1/2" NPSH	\$48.11
1046431	1-1/2" NST	\$48.11
1046450	2-1/2" NPSH	\$76.42
1046451	2-1/2" NST	\$76.42

 <p>Industrial Fog Nozzles ULC Approved Shut-off - Straight - Stream - Fog Ideal for industrial and commercial installation. Fog nozzles constructed of Polycarbonate material. 100 psi 10403 Plastic 3/4" = 8 GPM 1" = 22 GPM 1-1/2" = 75 GPM</p>		
Part #	Size	List Price
1040310	3/4" GHT Green	\$20.91
1040320	1" NPSH Red	\$24.53
1040321	1" NST Red	\$24.53
1040330	1-1/2" NPSH Red	\$20.75
1040331	1-1/2" NST Red	\$20.75
1040351	2-1/2" NST Red	\$135.38

 <p>Red Plastic Nozzle 100 psi</p>		
Part #	Size	List Price
1040332	1-1/2" NPSH non-UL Red Plastic	\$11.23
1040333	1-1/2" NST non-UL Red Plastic	\$11.23

 <p>Hose Pipe NPSH-NST-GHT 100 psi water only Not for hot water 13107 Brass</p>			
Part #	Size	Orifice	List Price
1310710	3/4" GHT x 6"	1/4"	\$8.11
1310715	3/4" NPSH x 6"	1/4"	\$10.75
1310720	1" NPSH x 8"	5/16"	\$15.57
1310730	1-1/4" NPSH x 9"	7/16"	\$20.00
1310740	1-1/2" NPSH x 10"	1/2"	\$22.08
1310741	1-1/2" NST x 10"	1/2"	\$22.08
1310760	2" NPSH x 10"	5/8"	\$30.66
1310770	2-1/2" NST x 12"	1"	\$47.08
1310771	2-1/2" NPSH x 12"	1"	\$47.08

 <p>Hose Pipe 100 psi 13107 Plastic Red</p>			
Part #	Size	Orifice	List Price
1310710P	1-1/2" NST	1/2"	\$10.38
1310720P	1-1/2" NPSH	1/2"	\$10.38





FIRE HOSE FITTINGS AND ACCESSORIES

Nozzle Style and Size	Inlet PSI	Pressure KPA	Straight GPM	Stream IPM	30 GPM	30 IPM	60 GPM	60 IPM	90 GPM	90 IPM
	50	345	18	68	21	79	24	91	27	102
10464	75	517	22	83	25	95	28	106	32	121
1"	100	690	24	91	28	106	32	121	36	136
	50	345	45	170	50	189	55	208	60	227
10464	75	517	50	189	55	208	65	246	75	284
1-1/2"	100	690	55	208	60	227	75	284	85	322
	50	345	90	341	120	454	130	492	145	549
10464	75	517	100	379	140	530	150	568	180	681
2-1/2"	100	690	110	416	165	625	180	681	205	776

Threads Per Inch				
	8"	9"	11"	11-1/2"
1-1/2" Size	2.100 (NYFD)	1.990 (NST)	2.093 (NYCORP)	1.878 (NPSH)



Threads Per Inch				
	6"	7"	7-1/2"	8"
1-1/2" Size	3.058	3.13	2.990 (CHICAGO)	3.062
	3.093		3.062 (NST)	3.093
	3.125		3.125 (DETROIT)	3.140
	3.156			3.156
	3.187			3.312
	3.234			3.031 (NYFD)
	3.250			3.00 (NY CORP)
	3.312			2.841 (NPSH)
	3.062 (PITTSBURGH)			3.78 (CLEVELAND)

P





FIRE HOSE FITTINGS AND ACCESSORIES

Ball Shutoff Nozzles

			
101BC		101	
<ul style="list-style-type: none"> •Bronze construction •Pistol Grip •1" Waterway •1-1/2" Swivel female NST by 1-1/2" male outlet NST. 		<ul style="list-style-type: none"> •Light weight alloy •Pistol Grip •1" Waterway •1-1/2" Swivel female NST by 1-1/2" male outlet NST. 	
Model #	Description	List Price	
101BC	1-1/2" Swivel Female NST X 1-1/2" Male Outlet NST. Bronze	\$665.21	
101	1-1/2" Swivel Female NST X 1-1/2" Male Outlet NST. Alloy	\$428.00	

Smooth Bore Nozzles Tips For Ball Shutoff

			
105		106	
<ul style="list-style-type: none"> •Handline Tip •1-1/2" Base Thread By 1-1/2" Outlet Thread. •7/8" Discharge 		<ul style="list-style-type: none"> •Plain tip •1-1/2" NST Inlet. •1-3/8" discharge. 	
Maximum working pressure is 200psi. All flow rates are based on 100psi.			
Model #	Description	List Price	
105	1-1/2" Base NST X 1-1/2" Tip NST.	\$103.68	
106	1-1/2" Base NST.	\$124.60	





FIRE HOSE FITTINGS AND ACCESSORIES

Selectable Gallonage Nozzles



- Constant flow select gallonage with multiple flow settings.
- Selected flow remains constant regardless of pattern change
- Multiple pattern detents for positive positioning of pattern
- Low through life maintenance due to the use of top quality materials
- Conforms to all aspects of NFPA 1964 (Spray Nozzles, Shutoff and Tips)

- Standard optimum operating pressure 100 psi
- Combination of fog and straight stream
- Superb wide fog pattern for Optimum personal protection
- Excellent performance at pressures as little as 50 psi
- Flush without shutting down

Model #	Flow (G.P.M)	Thread	Weight (Lbs)	Length	List Price
366	30-60-95-125	1-1/2" NST	3.5	8.5	\$795.87
367AP	95-125-150-200	1-1/2" NST	5.5	9.8	\$961.66
368	95-125-150-200-250	2-1/2" NST	5.9	10.8	\$1018.11

Marine Nozzles

These nozzles are designed and manufactured for fire fighting in the harsh marine environment. These meet the performance requirement of US Coast Guard and US MIL-N-24408, Type 1. Both of these nozzles are ideal for application of AFFF Foam.

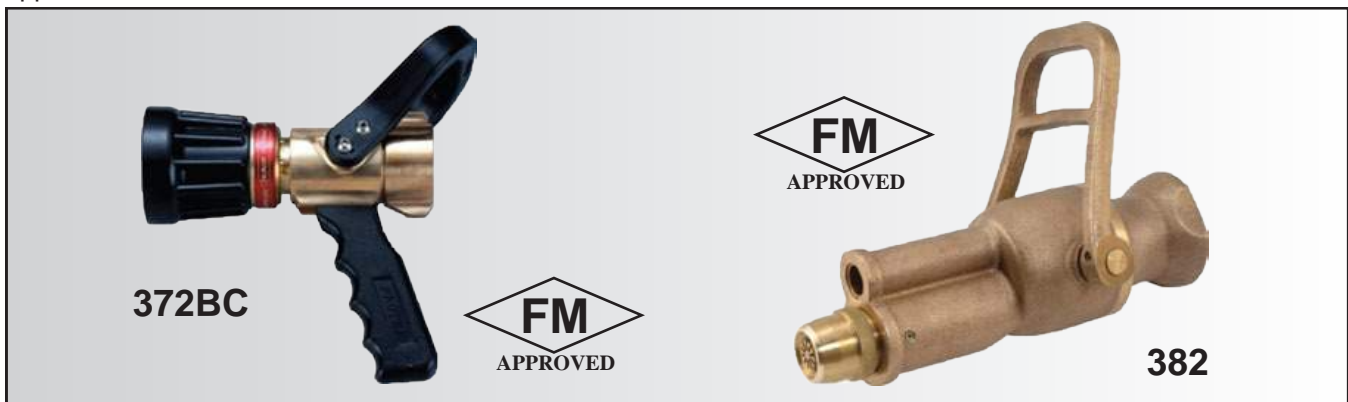

- Bronze construction
- US Coast Guard approval number: 162.027/17/0
- Heavy duty chrome plated metal shutoff ball ensure a smooth action and long dependable service life.
- Self-adjusting PTFE seat

- Bronze construction
- US Coast Guard approval number: 162.027/18/0
- Meets US Coast Guard specifications for fighting fires with drafted water
- Combination fog and straight stream
- Non clogging design

Model #	Flow (G.P.M)	Thread	Weight (Lbs)	Length	List Price
372BC	95	1-1/2" NST	7.7	8.1"	\$1109.06
382	95	1-1/2" NST	6.5	11.2"	\$1009.43



Master Stream Nozzles For Monitors



Automatic Fixed Pressure Master Stream Nozzle

Lightweight alloy.
 Automatically adjust to changes in flow and pressure.
 Maintains constant operating pressure over a wide range of flows.
 Flow from 300 to 1000 GPM.
 Pattern easily changed with large control handling.

830

Length: 8.2"
 Weight: 13 lbs.

Description	List Price
2-1/2" NST Swivel Inlet	\$1386.79



Adjustable Flow-Baffle Monitor Nozzles

Adjustable GPM with Spinning Teeth

Model #	Flow	Length	Weight	List Price
818	15, 30, 45 GPM	6"	2 lbs	\$572.64
819	60, 95, 125 GPM	6"	2 lbs	\$572.64
820	200, 250, 350 GPM	6"	2 lbs	\$572.64



Master Stream Nozzle

Vary flow settings with easy turn of the baffle fixed teeth.
 Built-in stream shaper.
823-BC FM Approved

Model #	Inlet	Materials	Flow	Length	Weight	List Price
822	2-1/2" NST	Alloy	250, 375, 500 GPM	7"	4 lbs	\$613.55
822-BC	2-1/2" NST	Bronze	250, 375, 500 GPM	7"	12.5 lbs	\$773.23
823	2-1/2" NST	Alloy	300, 500, 700 GPM	7"	4 lbs	\$576.87
823-BC	2-1/2" NST	Bronze	300, 500, 700 GPM	7"	12.5 lbs	\$754.06





FIRE HOSE ACCESSORIES

Gated Wyes

Brass Wye Bronze Leader Line Wye

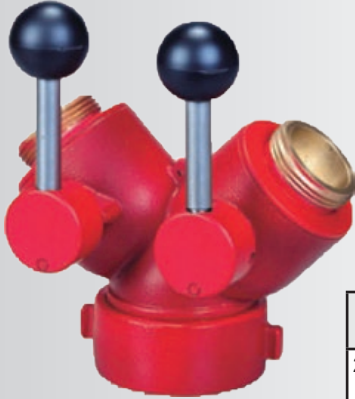

Weight 9 lbs.

520-BC

Description	List Price
2-1/2" Female NST x 1-1/2" MNST x 1-1/2" MNST	\$556.60

Maximum working pressure is 200psi

Leader Line Siamese Quarter Turn Ball Type



Brass Iron Handle

150 psi water

Model #	Size	List Price
1733730	2-1/2" NH x 1-1/2" NH x 1-1/2" NH	\$197.25
1733731	2-1/2" NPSH x 1-1/2" NH x 1-1/2" NH	\$197.25



520



530

Leader Line Wye (Aluminum Hardcoat)

Self locking handle for positive positioning

Maximum working pressure is 200psi

Model #	Size	List Price
520	2-1/2" FNST x 1-1/2" MNST x 1-1/2" MNST	\$471.32
530	2-1/2" FNST x 1-1/2" MNST x 1-1/2" MNST	\$746.47



505



506

Forestry Wyes (Aluminum Hardcoat)

Weight 2.3 lbs

Maximum working pressure is 200psi

Model #	Size	List Price
505	1" Female NPSH x 1" Male NPSH x 1" Male NPSH	\$379.08
506	1-1/2" Female NST x 1-1/2" Male NST x 1-1/2" Male NST	\$379.08

P



Siamese and Gate Valves



Suction Siamese (Lightweight Alloy)

Used as suction inlet collector for pumpers
 Self Locking Handle
 Weight 15.1 lbs

Maximum working pressure is 200psi

Model #	Description	List Price
545	(2) 2-1/2" Female NST Swivel Inlets with Strainers x 2-1/2 Male NST Outlets	1452.83
545BC	Brass	\$1830.19



3 - Way Suction Siamese (Lightweight Alloy)

Used as suction collector for Pumpers
 Self Locking Handle

Weight 20 lbs.

Maximum working pressure is 200psi

Model #	Description	List Price
555	(3) 2-1/2" Female NST Swivel Inlets with Strainer x 2-1/2" Female NST Outlet	\$1698.11



2-1/2" Hydrant Valve (Lightweight Alloy)

2-1/2" Full Flow Waterway
 Self locking handle for positive positioning

Weight 7 lbs.

Model #	Description	List Price
595	2-1/2" Female NST x 2-1/2" Male NST	\$627.97



2-1/2" Gate Valve (Lightweight Alloy)

Wedge Seat Gate Valve
 Non-Rising Stem Design
 Crank Handle

Weight 4.5 lbs.

Maximum working pressure is 200psi

Model #	Description	List Price
596	2-1/2" Female NST x 2-1/2" Male Outlet	\$519.17





FIRE HOSE ACCESSORIES

Gated Wyes

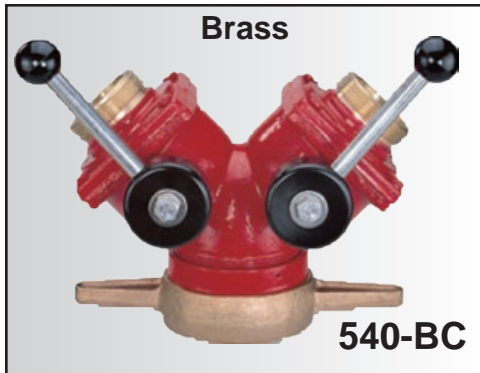

Hydrant Wye

Bronze Construction

Weight 33 lbs.

Maximum working pressure is 200psi

Model #	Description	List Price
540-BC	2-1/2" Female NST x 2-1/2" MNST x 2-1/2" MNST	\$2056.60



Hydrant Wye (Aluminum Hardcoat)

Maximum working pressure is 200psi

Model #	Description	List Price
540	2-1/2" Female NST x 2-1/2" MNST x 2-1/2" MNST	\$1349.47
541	2-1/2" Female NST x 2-1/2" MNST x 2-1/2" MNST w/ Self locking handle for positive positioning	\$716.60



3 - Way Hydrant Wye

Weight 21.6 lbs.

Maximum working pressure is 200psi

Model #	Description	List Price
550	2-1/2" Female NST x (3) 2-1/2" Male NST w/ Self Locking Handle	\$1564.62

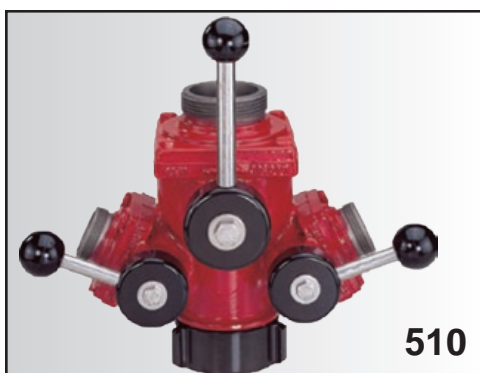

Water Thief (Aluminum Hardcoat)

Self Locking Handle. Used for laying, extending, or adding 1-1/2" or 2-1/2" lines without interfering with operation of other lines

Weight 13.5 lbs.

Maximum working pressure is 200psi

Model #	Description	List Price
510	2-1/2" Female NST x 2-1/2" Male NST x (2) 1-1/2" Male NST	\$1452.83

P



Industrial Monitor



Single Waterway Monitor

FM Approved
Corrosion resistant bronze construction ideal for Marine, Offshore, Industrial or other corrosive environments.
Full 3" Waterway.
Flow up to 1250 GPM.
Travel 90 degree above to 60 degree below
Horizontal positive friction locks on both horizontal and vertical travel.

1250 GPM
Height 17 in., Width 11.5 in.
Weight 54 lbs.

Model #	Description	List Price
649	4" Male NPT	\$2658.49
649-1	4" Flanged Inlet x 2-1/2" NST Outlet	\$2658.49



Single Waterway Monitor Seamless Brass Tube Construction

2.5" Waterway
Flows up to 1250 GPM.
360 degree horizontal and 135 degree vertical.
Travel 90 degree above to 45 degree below horizontal.
Positive friction locks on both horizontal and vertical travel.
Low friction loss.

1250 GPM
Height 18 in., Width 18 in.
Weight 45 lbs.

Model #	Description	List Price
736	4" Male NPT	\$2658.49
736-1	4" Flanged Inlet x 2-1/2" NST Outlet	\$2658.49



Hydrant Mount

Allows a monitor to be mounted on any 2-1/2" Hydrant Outlet.
Adjustable Height: From 17" to 28" from ground.
Length 9-1/2" from swivel to middle of flange 2-1/2" Swivel Inlet NST.

Weight 40 lbs.

Description	List Price
4" ANSI Outlet Flange	\$1716.04

P

Industrial Monitor



FM Approved-Single Water Monitor

Corrosion resistant bronze construction. Ideal for Marine, Offshore, Industrial or other corrosive environments. Full 3" Water way flows up to 1250 GPM. Full 360 degree rotation with positive twist lock. Vertical travel from 70 degrees above to 70 degrees below horizontal. Vertical travel is controlled by hand wheel with worm gear fully enclosed. Worm Gear is protected from elements with double row Stainless Steel Ball Bearings at all rotation joints.

1250 GPM
Height 16 in., Width 15 in.

Weight 56 lbs.

Model #	Description	List Price
611	4" NPT X 2-1/2" NST outlet	\$2469.81
611-1	4" Flange X 2-1/2" NST outlet	\$2469.81



FM Approved-Dual Waterway Monitor

Corrosion Resistant Bronze construction
Flows up to 750 GPM
Full 360 degree rotation with positive twist lock
Vertical travel of 130 degree from 70 degrees above to 60 degrees below horizontal.

750GPM
Height 18 in., Width 14 in.

Weight 4.5 lbs.

Model #	Description	List Price
636	4" NPT X 2-1/2" NST outlet	\$2113.21
636-1	4" Flange X 2-1/2" NST outlet	\$2113.21

Storz Couplings



Storz x Female		
Part #	Size	List Price
ST4025FNH	4" x 2-1/2" NST	\$263.64
ST5025FNH	5" x 2-1/2" NST	\$419.87
ST5045FNH	5" x 4-1/2" NST	\$468.68
ST5040FNPT	5" x 4" NPT	\$482.36
ST5050FNPT	5" x 5" NPT	\$499.96
ST5060FNPT	5" x 6" NPT	\$538.98



Storz x RL Swivel Female		
Part #	Size	List Price
ST4025FSNST	4" x 2-1/2" NST	\$335.89
ST4040FSNST	4" x 4" NST	\$410.09
ST4045FSNST	4" x 4-1/2" NST	\$439.40
ST5025FSNST	5" x 2-1/2" NST	\$406.19
ST5040FSNST	5" x 4" NST	\$458.92
ST5045FSNST	5" x 4-1/2" NST	\$449.15



Storz x Rigid Male Adapter		
Part #	Size	List Price
ST2525MNST	2-1/2" x 2-1/2" NST	\$100.87
ST4025MNST	4" x 2-1/2" NST	\$257.77
ST5025MNST	5" x 2-1/2" NST	\$345.66
ST5045MNST	5" x 4-1/2" NST	\$355.42



Storz Cap		
Part #	Size	List Price
ST40	4"	\$157.79
ST50	5"	\$219.92



Adjustable Combination Spanner



Steel handle with cast iron zinc plated head

Part #	List Price
2619050	\$15.98
2618950	\$17.98

Hydrant Wrench Non-Slip



Zinc Plated

Part #	Description	List Price
2619050	Square & Pentagon up to 1"	\$69.81
2618950	Square & Pentagon larger than 1"	\$69.81

Universal Spanner



Cast iron painted red

Part #	List Price
2623350	\$7.91

Spanner Wrench



Zinc Plated

Part #	Size	List Price
SP 150	1-1/2"	\$2.58
SP 200	2"	\$2.74
SP 250	2-1/2"	\$3.19
SP 300	3"	\$4.49
SP 400	4"	\$5.19
SP 600	6"	\$6.13

Hose Reels



Open Spring-Driven Reels Epoxy Coated Steel

Reels With Hose 35' & 50' Hose Low Pressure (300 psi)

Part #	Size	List Price
GSA-2L35-P	1/4" X 35'	\$471.70
GSA-3L35-P	3/8" X 35'	\$584.91
GSA-3L50-P	3/8" X 50'	\$692.45
GSA-4L50-P	1/2" X 50'	\$783.02

Reels Without Hose 35' & 50' Size Low Pressure (300 psi)

Part #	Size	List Price
GSA-3L35-PN	3/8" X 35'	\$490.57
GSA-3L50-PN	3/8" X 50'	\$566.04
GSA-4L50-PN	1/2" X 50'	\$773.58

Reels Without Hose Medium Pressure (2250 psi)

Part #	Size	List Price
GSA-3M50-PN	3/8" X 50'	\$777.36

Reels Without Hose Medium Pressure (2000 psi)

Part #	Size	List Price
GSA-4M50-PN	1/2" X 50'	\$849.06

P



NEEDLES VALVES AND SNUBBERS

Needle Valves / (Large Body Style)

10,000 psi 316 Stainless Steel			
Part Number	Size	Style	List Price
N1311	1/8"	FxF	\$56.62
N1312	1/4"	FxF	\$56.62
N1313	3/8"	FxF	\$60.57
N1314	1/2"	FxF	\$64.40
N1316	3/4"	FxF	\$92.77
N1318	1"	FxF	\$144.96
N1332	1/4"	MxF	\$70.87
N1334	1/2"	MxF	\$74.09
N1352	1/4"	FxF Angle	\$70.87
N1354	1/2"	FxF Angle	\$74.09
N1372	1/4"	MxF Angle	\$70.87
N1374	1/2"	MxF Angle	\$74.09

6000 psi 316 Stainless Miniature			
Part Number	Size	Style	List Price
N0311	1/8"	FxF	\$62.45
N0312	1/4"	FxF	\$62.45
N0332	1/4"	MxF	\$62.45

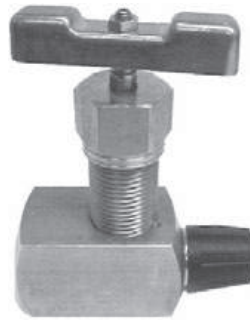

FxM

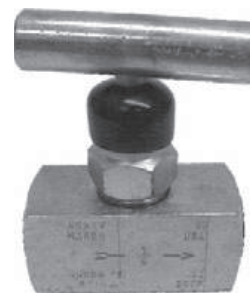

FxF

10,000 psi Carbon Steel			
Part Number	Size	Style	List Price
N1512	1/4"	FxF	\$29.02
N1513	3/8"	FxF	\$35.45
N1514	1/2"	FxF	\$37.36
N1516	3/4"	FxF	\$44.42
N1518	1"	FxF	\$80.47
N1532	1/4"	MxF	\$37.36
N1534	1/2"	MxF	\$37.36
N1552	1/4"	FxF Angle	\$40.57
N1554	1/2"	FxF Angle	\$42.49
N1572	1/4"	MxF Angle	\$40.57
N1574	1/2"	MxF Angle	\$42.49

6000 psi Carbon Steel Miniature			
Part Number	Size	Style	List Price
N0511	1/8"	FxF	\$34.83
N0512	1/4"	FxF	\$34.83
N0532	1/4"	MxF	\$34.83

Needle Valves / (Small Body Style)

Designed for applications where caustic liquids and corrosive media are common.

Hard Seat Valves 316 Stainless Steel

10,000 psi 316 Stainless Steel			
Part Number	Size	Style	List Price
SS0011	1/8"	FxF	\$30.98
SS0012	1/4"	FxF	\$30.98
SS0013	3/8"	FxF	\$58.64
SS0014	1/2"	FxF	\$61.92
SS0016	3/4"	FxF	\$178.57
SS0018	1"	FxF	\$203.09
SS0032	1/4"	MxF	\$34.21
SS0034	1/2"	MxF	\$62.49
SS0052	1/4"	FxF Angle	\$37.36
SS0054	1/2"	FxF Angle	\$65.00
SS0072	1/4"	MxF Angle	\$37.36
SS0074	1/2"	MxF Angle	\$65.00

6000 psi 316 Stainless Miniature			
Part Number	Size	Style	List Price
SSM011	1/8"	FxF	\$25.77
SSM012	1/4"	FxF	\$28.36
SSM032	1/4"	MxF	\$25.77



Designed for applications where non corrosive media are used, air, water and oil.

Hard Seat Valves Alloy Steel

10,000 psi Carbon Steel			
Part Number	Size	Style	List Price
CS0011	1/8"	FxF	\$21.92
CS0012	1/4"	FxF	\$21.92
CS0013	3/8"	FxF	\$30.32
CS0014	1/2"	FxF	\$31.60
CS0016	3/4"	FxF	\$89.53
CS0018	1"	FxF	\$96.06
CS0032	1/4"	MxF	\$21.92
CS0034	1/2"	MxF	\$33.51
CS0052	1/4"	FxF Angle	\$24.47
CS0054	1/2"	FxF Angle	\$42.49
CS0072	1/4"	MxF Angle	\$24.47
CS0074	1/2"	MxF Angle	\$42.49

6000 psi Carbon Steel Miniature			
Part Number	Size	Style	List Price
CSM011	1/8"	FxF	\$19.34
CSM012	1/4"	FxF	\$19.34
CSM032	1/4"	MxF	\$19.34





BALL VALVES

Applications: Plumbing or heating projects, low pressure steam, compressed air, HVAC

Brass Ball Valves

PTFE seat

					
400 WOG/CWP - 2 Piece Full Bore			600 WOG/CWP - 2 Piece Full Bore		
Size	Part Number	List Price	Size	Part Number	List Price
1/4"	BFV 025400B	\$5.34	1/4"	BFV 025600B	\$4.94
3/8"	BFV 038400B	\$4.91	3/8"	BFV 038600B	\$4.94
1/2"	BFV 050400B	\$6.89	1/2"	BFV 050600B	\$5.98
3/4"	BFV 075400B	\$9.34	3/4"	BFV 075600B	\$8.77
1"	BFV 100400B	\$15.00	1"	BFV 100600B	\$14.58
1-1/4"	BFV 125400B	\$22.45	1-1/4"	BFV 125600B	\$23.30
1-1/2"	BFV 150400B	\$33.98	1-1/2"	BFV 150600B	\$30.94
2"	BFV 200400B	\$53.96	2"	BFV 200600B	\$47.55
2-1/2"	BFV 250400B	\$101.34	2-1/2"	BFV 250600B	\$105.09
3"	BFV 300400B	\$152.36	3"	BFV 300600B	\$135.94
4"	BFV 400400B	\$215.57	4"	BFV 400600B	\$215.94

* 3" also carried with BSP threads.

WOG= Rating indicates the maximum non-shock pressure at ambient temperatures at which the valve may be used.
CWP=Cold working pressure



Brass Ball Valves

PTFE seat



								
1/4" thru 1" Good for 125psi LP gas			1/4" thru 1" Good for 125psi LP gas					
400 WOG/CWP - 2 Piece Standard Port UL Listed			600 WOG/CWP - 2 Piece Full Bore UL Listed			Lead Free Brass Ball Valves		
Size	Part Number	List Price	Size	Part Number	List Price	Size	Part Number	List Price
1/4"	BV 025	\$8.74	1/4"	BFV 025	\$4.53	1/4"	BFVLF 025600B	\$6.43
3/8"	BV 038	\$8.74	3/8"	BFV 038	\$5.09	3/8"	BFVLF 038600B	\$5.79
1/2"	BV 050	\$8.74	1/2"	BFV 050	\$7.17	1/2"	BFVLF 050600B	\$8.49
3/4"	BV 075	\$15.57	3/4"	BFV 075	\$11.52	3/4"	BFVLF 075600B	\$12.30
1"	BV 100	\$17.58	1"	BFV 100	\$18.75	1"	BFVLF 100600B	\$20.38
1-1/4"	BV 125	\$33.60	1-1/4"	BFV 125	\$25.85	1-1/4"	BFVLF 125600B	\$30.72
1-1/2"	BV 150	\$45.42	1-1/2"	BFV 150	\$40.15	1-1/2"	BFVLF 150600B	\$45.26
2"	BV 200	\$50.11	2"	BFV 200	\$56.98	2"	BFVLF 200600B	\$69.11
2-1/2"	BV 250	\$156.30						
3"	BV 300	\$302.87						
4"	BV 400	\$555.66						

S





BALL VALVES

Stainless Steel Ball Valves PTFE seat

 <p>316 Stainless</p>			 <p>316 Stainless Locking Handle</p>			 <p>316 Stainless</p>		
1PC 1000 WOG/CWP Standard Port			1PC 1000 WOG/CWP Standard Port			1PC 2000 WOG/CWP Standard Port*		
Size	Part Number	List Price	Size	Part Number	List Price	Size	Part Number	List Price
1/4"	SV 025NL	\$10.55	1/4"	SV 025	\$10.55	1/4"	SV 025-2	\$14.02
3/8"	SV 038NL	\$10.55	3/8"	SV 038	\$10.55	3/8"	SV 038-2	\$14.13
1/2"	SV 050NL	\$13.87	1/2"	SV 050	\$13.87	1/2"	SV 050-2	\$25.94
3/4"	SV 075NL	\$16.38	3/4"	SV 075	\$16.38	3/4"	SV 075-2	\$33.23
1"	SV 100NL	\$21.34	1"	SV 100	\$21.34	1"	SV 100-2	\$41.09
1-1/4"	SV 125NL	\$31.26	1-1/4"	SV 125	\$31.26	1-1/4"	SV 125-2 *	\$64.51
1-1/2"	SV 150NL	\$37.09	1-1/2"	SV 150	\$37.09	1-1/2"	SV 150-2 *	\$76.74
2"	SV 200NL	\$62.34	2"	SV 200	\$62.34	2"	SV 200-2 *	\$141.21
2-1/2"	--	--	2-1/2"	--	--	1/4" thru 1" is 2000 WOG		
3"	--	--	3"	--	--	* 1-1/4" thru 2" 1500 WOG		

WOG= Rating indicates the maximum non-shock pressure at ambient temperatures at which the valve may be used.
CWP=Cold working pressure

Stainless Steel Ball Valves PTFE seat

 <p>316 Stainless Locking Handle</p>			 <p>316 Stainless Locking Handle</p>			 <p>304 Stainless Locking Handle</p>		
2PC 1000 WOG/CWP Full Bore			3PC 1000 WOG/CWP Full Port			1PC 1000 WOG/CWP Standard Port		
Size	Part Number	List Price	Size	Part Number	List Price	Size	Part Number	List Price
1/4"	SFV 025	\$12.08	1/4"	SSFV 025	\$15.60	1/4"	SV 025SS304	\$9.81
3/8"	SFV 038	\$12.08	3/8"	SSFV 038	\$15.60	3/8"	SV 038SS304	\$9.81
1/2"	SFV 050	\$15.00	1/2"	SSFV 050	\$21.06	1/2"	SV 050SS304	\$13.91
3/4"	SFV 075	\$22.36	3/4"	SSFV 075	\$28.40	3/4"	SV 075SS304	\$16.00
1"	SFV 100	\$29.98	1"	SSFV 100	\$38.02	1"	SV 100SS304	\$20.66
1-1/4"	SFV 125	\$47.83	1-1/4"	SSFV 125	\$60.30	1-1/4"	SV 125SS304	\$30.11
1-1/2"	SFV 150	\$67.26	1-1/2"	SSFV 150	\$77.19	1-1/2"	SV 150SS304	\$36.49
2"	SFV 200	\$103.75	2"	SSFV 200	\$129.26	2"	SV 200SS304	\$58.32
2-1/2"	SFV 250	\$202.72	2-1/2"	SSFV 250	\$248.83	2-1/2"	SV 250SS304	\$130.26
3"	SFV 300	\$306.57	3"	SSFV 300	\$341.81	3"	SV 300SS304	\$174.79
--	--	--	4"	SSFV 400	\$742.64	--	--	--



Ball Type Valve w/ Cam Adapter

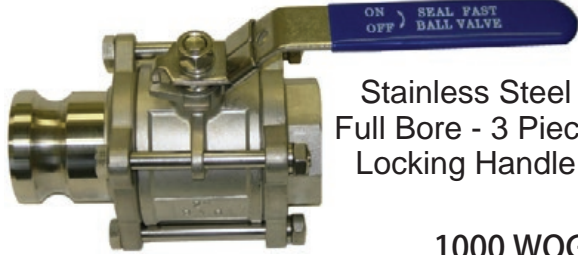

Stainless Steel
Full Bore - 3 Piece
Locking Handle

1000 WOG

Part Number	Size	List Price
SSFV200A	2" NPT Female X 2" Cam Adapter	\$155.13

Flange End Ball Valve



Flange End
Stainless Steel
Full Port - 2 Piece

150 WOG

Size	Part Number	List Price
1"	SFLV 100	\$105.57
1-1/2"	SFLV 150	\$183.74
2"	SFLV 200	\$266.38
3"	SFLV 300	\$555.45

Carbon Steel Ball Valve

1 Piece - 1000 WOG
Standard Port



Size	Part Number	List Price
1/4"	CV 025	\$9.06
3/8"	CV 038	\$9.06
1/2"	CV 050	\$11.89
3/4"	CV 075	\$13.77
1"	CV 100	\$17.55
1-1/4"	CV 125	\$24.66
1-1/2"	CV 150	\$30.55
2"	CV 200	\$47.06

Butterfly Valve Truewafer



10 Position Handle
Buna - N Seat
Ductile Iron
Nickel Plated Disc

WV 4N

Size	Part Number	List Price
2"	WV 2N	\$36.51
3"	WV 3N	\$51.58
4"	WV 4N	\$69.64
6"	WV 6N	\$103.02
8"	WV 8N	\$172.64
10"	WV 10N	\$256.81
12"	WV 12N	\$364.30

Gas Ball Valve

Brass

AGA Approved - UL Listed



T-Handle

Size	Part Number	List Price
3/8"	AGA 038	\$10.38
1/2"	AGA 050	\$10.19
3/4"	AGA 075	\$11.79
1"	AGA 100	\$25.36

Screw End Body Butterfly Valve

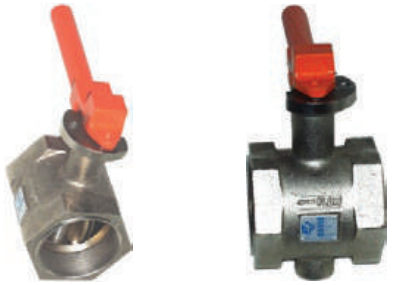

2 Position Handle Open or Close
Buna-N Seals Aluminum-Bronze Disc

Size	Part Number	List Price
3"	SV3	\$176.98
4"	SV4	\$241.51



Brass Lever Valves



Size	Part Number	List Price
2"	LV200NPT	\$88.66
3"	LV300NPT	\$150.92
4"	LV400NPT	\$226.40
6"	LV600NPT	\$442.77



*Actual valve may not look like picture



Syraco Oil and Molasses Gate Valves			Bibb Faucet Brass			Garden Hose Wye Brass	
Self-Closing #S23 & #S71 Long Handle #23 *Suitable for non-flammable liquids only							
Size	Part Number	List Price	Size	Part Number	List Price	Part Number	List Price
3/4"	S71	\$103.30	1/2"	105-50	\$5.26	21A-12	\$4.23
2"	23	\$149.83	3/4"	105-75	\$6.02	--	--
2"	S23	\$256.66	--	--	--	--	--

Gate Valves Stainless

Syraco Oil & Molasses Gate Valves

 <p>Features:</p> <ul style="list-style-type: none"> · Body; ASTM A351-CF8M · Screwed Bonnet · Disc; ASTM A351-CF8M, Wedge Disc · 200 WOG, NPT Thread · Inside Screw · Handwheel Operated 			 <p>Cast Iron Body *Suitable for non-flammable liquids only</p>		
Size	Part Number	List Price	Size	Part Number	List Price
1/2"	GV 050SS	\$28.23	3/4"	71	\$65.51
3/4"	GV 075SS	\$35.25	1"	72	\$84.96
1"	GV 100SS	\$47.55	1-1/4"	73	\$79.89
1-1/4"	GV 125SS	\$71.49	1-1/2"	74	\$82.21
1-1/2"	GV 150SS	\$91.75	2"	75	\$88.26
2"	GV 200SS	\$133.74	3"	39	\$234.53
			4"	40	\$526.62
			--	--	--

<p>Cold water, Oil or Gas</p> <p>Brass</p> 	<h3>Gate Valves Brass</h3> <table border="1"> <thead> <tr> <th>Size</th> <th>Part Number</th> <th>List Price</th> </tr> </thead> <tbody> <tr><td>1/4"</td><td>GV 025</td><td>\$7.74</td></tr> <tr><td>3/8"</td><td>GV 038</td><td>\$7.74</td></tr> <tr><td>1/2"</td><td>GV 050</td><td>\$5.62</td></tr> <tr><td>3/4"</td><td>GV 075</td><td>\$6.53</td></tr> <tr><td>1"</td><td>GV 100</td><td>\$9.19</td></tr> <tr><td>1-1/4"</td><td>GV 125</td><td>\$15.49</td></tr> <tr><td>1-1/2"</td><td>GV 150</td><td>\$22.15</td></tr> <tr><td>2"</td><td>GV 200</td><td>\$29.43</td></tr> <tr><td>2 1/2"</td><td>GV 250</td><td>\$74.53</td></tr> <tr><td>3"</td><td>GV 300</td><td>\$93.79</td></tr> <tr><td>4"</td><td>GV 400</td><td>\$172.74</td></tr> </tbody> </table>			Size	Part Number	List Price	1/4"	GV 025	\$7.74	3/8"	GV 038	\$7.74	1/2"	GV 050	\$5.62	3/4"	GV 075	\$6.53	1"	GV 100	\$9.19	1-1/4"	GV 125	\$15.49	1-1/2"	GV 150	\$22.15	2"	GV 200	\$29.43	2 1/2"	GV 250	\$74.53	3"	GV 300	\$93.79	4"	GV 400	\$172.74	<h3>Globe Valves Brass</h3> <table border="1"> <thead> <tr> <th>Size</th> <th>Part Number</th> <th>List Price</th> </tr> </thead> <tbody> <tr><td>--</td><td>--</td><td>--</td></tr> <tr><td>--</td><td>--</td><td>--</td></tr> <tr><td>1/2"</td><td>GLV 050</td><td>\$8.34</td></tr> <tr><td>3/4"</td><td>GLV 075</td><td>\$12.32</td></tr> <tr><td>1"</td><td>GLV 100</td><td>\$18.57</td></tr> <tr><td>1-1/4"</td><td>GLV 125</td><td>\$30.60</td></tr> <tr><td>1-1/2"</td><td>GLV 150</td><td>\$44.23</td></tr> <tr><td>2"</td><td>GLV 200</td><td>\$68.51</td></tr> <tr><td>--</td><td>--</td><td>--</td></tr> <tr><td>--</td><td>--</td><td>--</td></tr> <tr><td>--</td><td>--</td><td>--</td></tr> </tbody> </table>			Size	Part Number	List Price	--	--	--	--	--	--	1/2"	GLV 050	\$8.34	3/4"	GLV 075	\$12.32	1"	GLV 100	\$18.57	1-1/4"	GLV 125	\$30.60	1-1/2"	GLV 150	\$44.23	2"	GLV 200	\$68.51	--	--	--	--	--	--	--	--	--
	Size	Part Number	List Price																																																																											
1/4"	GV 025	\$7.74																																																																												
3/8"	GV 038	\$7.74																																																																												
1/2"	GV 050	\$5.62																																																																												
3/4"	GV 075	\$6.53																																																																												
1"	GV 100	\$9.19																																																																												
1-1/4"	GV 125	\$15.49																																																																												
1-1/2"	GV 150	\$22.15																																																																												
2"	GV 200	\$29.43																																																																												
2 1/2"	GV 250	\$74.53																																																																												
3"	GV 300	\$93.79																																																																												
4"	GV 400	\$172.74																																																																												
Size	Part Number	List Price																																																																												
--	--	--																																																																												
--	--	--																																																																												
1/2"	GLV 050	\$8.34																																																																												
3/4"	GLV 075	\$12.32																																																																												
1"	GLV 100	\$18.57																																																																												
1-1/4"	GLV 125	\$30.60																																																																												
1-1/2"	GLV 150	\$44.23																																																																												
2"	GLV 200	\$68.51																																																																												
--	--	--																																																																												
--	--	--																																																																												
--	--	--																																																																												
<p>Brass Gate and Globe Valves Class 125</p>	<p>150 psi, WOG Non-Shock Non Rising Stem</p>	<p>Screwed Bonnet</p>																																																																												





Brass Spring Check Valve With Filter

Brass Spring Check Valve

 200 WOG			 200 WOG		
Size	Part Number	List Price	Size	Part Number	List Price
1/2"	SLCVF050	\$2.75	1/2"	SLCV050	\$3.89
3/4"	SLCVF075	\$4.40	3/4"	SLCV075	\$5.42
1"	SLCVF100	\$6.13	1"	SLCV100	\$8.23
1-1/4"	SLCVF125	\$9.42	1-1/4"	SLCV125	\$9.62
1-1/2"	SLCVF150	\$12.17	1-1/2"	SLCV150	\$14.21
2"	SLCVF200	\$21.58	2"	SLCV200	\$20.38
2-1/2"	SLCVF250	\$38.66	2-1/2"	SLCV250	\$60.85
3"	SLCVF300	\$43.53	3"	SLCV300	\$83.98
4"	SLCVF400	\$73.87	4"	SLCV400	\$119.23

Brass Y-Type Strainer

Stainless Y-Type Strainer

 150 WOG			 Features: <ul style="list-style-type: none"> · Standard Length · Body & Cap; ASTM A351-CF8M · Screen; S/S304 20 Mesh · Hole Size 1.0mm · 800 WOG, NPT Thread · Replacement Screens Available 		
Size	Part Number	List Price	Size	Part Number	List Price
1/2"	YS050	\$5.75	1/2"	YS050SS	\$14.62
3/4"	YS075	\$8.64	3/4"	YS075SS	\$18.57
1"	YS100	\$12.19	1"	YS100SS	\$27.92
1-1/4"	YS125	\$19.79	1-1/4"	YS125SS	\$42.45
1-1/2"	YS150	\$27.00	1-1/2"	YS150SS	\$50.28
2"	YS200	\$47.08	2"	YS200SS	\$76.77

Brass Swing Check Valve

Stainless Swing Check Valve

 150 WOG			 Features: <ul style="list-style-type: none"> · Body; ASTM A351-CF8M · Cap; Screwed · Disc; ASTM A351-CF8M, Swing Type · 200 WOG, NPT Thread · Integral Seat 		
Size	Part Number	List Price	Size	Part Number	List Price
1/2"	SC 050	\$5.94	1/2"	SC050SS	\$21.02
3/4"	SC 075	\$8.40	3/4"	SC075SS	\$31.72
1"	SC 100	\$12.30	1"	SC100SS	\$44.45
1-1/4"	SC 125	\$18.21	1-1/4"	SC125SS	\$63.47
1-1/2"	SC 150	\$25.94	1-1/2"	SC150SS	\$86.04
2"	SC 200	\$43.77	2"	SC200SS	\$125.85
3"	SC 300	\$96.04			
4"	SC 400	\$191.85			

S



41 Series - Polished Brass

Note: Parts may not look exactly like pictures.

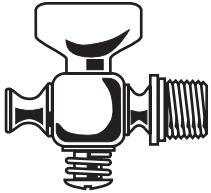

**Tee Handle
Round Shoulder**

Part Number	Size	List Price
4106001	1/8"	\$5.58
4107001	1/4"	\$6.04

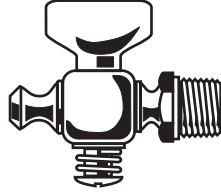

**Tee Handle
Hexagon Shoulder**

Part Number	Size	List Price
4108001	3/8"	\$8.28
4109001	1/2"	\$10.64

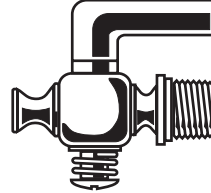

**Lever Handle
Round Shoulder**

Part Number	Size	List Price
4112001	1/8"	\$5.94
4113001	1/4"	\$6.42

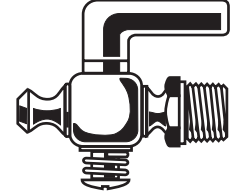

**Lever Handle
Hexagon Shoulder**

Part Number	Size	List Price
4114001	3/8"	\$9.32
4115001	1/2"	\$11.70

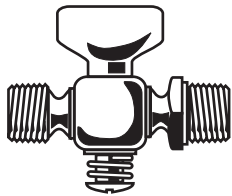

**Tee Handle
Double Male**

Part Number	Size	List Price
4118001	1/8"	\$5.58
4119001	1/4"	\$6.04
4120301	3/8"	\$8.57
4121001	1/2"	\$10.94

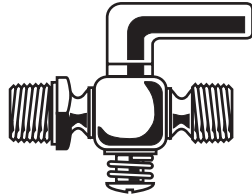

**Lever Handle
Double Male**

Part Number	Size	List Price
4122001	1/8"	\$5.94
4123001	1/4"	\$6.42
4124001	3/8"	\$9.32
4125101	1/2"	\$11.70

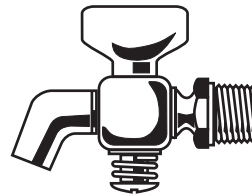

**Tee Handle
Bibb Nose**

Part Number	Size	List Price
4126001	1/8"	\$5.58
4127001	1/4"	\$6.04
4128001	3/8"	\$8.57
4133001	1/2"	\$10.94

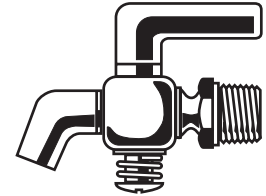

**Lever Handle
Bibb Nose**

Part Number	Size	List Price
4129001	1/8"	\$5.94
4130001	1/4"	\$6.42
4131001	3/8"	\$9.32
4132001	1/2"	\$9.38

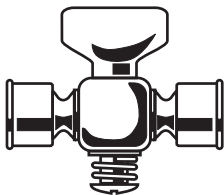

**Tee Handle
Double Female**

Part Number	Size	List Price
4137001	1/8"	\$5.58
4138001	1/4"	\$6.04
4139001	3/8"	\$8.57
4139101	1/2"	\$10.94

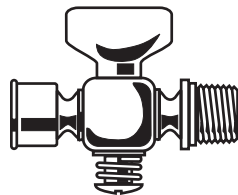

**Tee Handle
Female X Male**

Part Number	Size	List Price
4140001	1/8"	\$5.94
4141001	1/4"	\$6.42
4142001	3/8"	\$9.32
4142101	1/2"	\$11.70

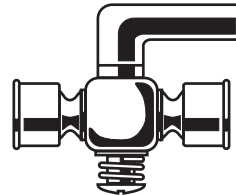

**Lever Handle
Double Female**

Part Number	Size	List Price
4143001	1/8"	\$5.58
4144001	1/4"	\$6.04
4145001	3/8"	\$8.57
4145101	1/2"	\$10.94

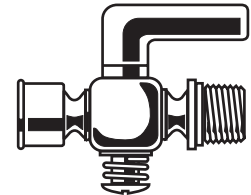

**Lever Handle
Female X Male**

Part Number	Size	List Price
4146001	1/8"	\$5.94
4147001	1/4"	\$6.42
4148001	3/8"	\$9.32
4148101	1/2"	\$11.70





41 Series - Polished Brass

Note: Parts may not look exactly like pictures.

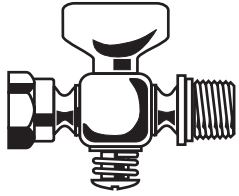

Hexagon Shoulder Tee Handle - Female X Male

Part Number	Size	List Price
4149001	1/8"	\$5.58
4150001	1/4"	\$6.04
4151001	3/8"	\$8.57
4151101	1/2"	\$10.94

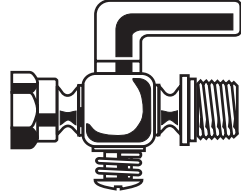

Hexagon Shoulder Lever Handle - Female X Male

Part Number	Size	List Price
4152001	1/8"	\$5.94
4153001	1/4"	\$6.42
4154001	3/8"	\$9.32
4154101	1/2"	\$11.70

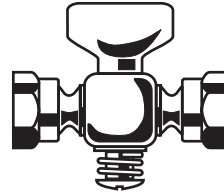

Hexagon Shoulder Tee Handle - Double Female

Part Number	Size	List Price
4155001	1/8"	\$5.58
4156001	1/4"	\$6.04
4157001	3/8"	\$8.57
4157101	1/2"	\$10.94

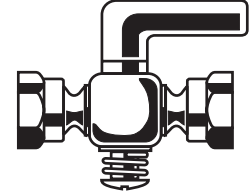

Hexagon Shoulder Lever Handle - Double Female

Part Number	Size	List Price
41-580-01	1/8"	\$5.94
41-590-01	1/4"	\$6.42
41-600-01	3/8"	\$9.32
41-601-01	1/2"	\$11.70

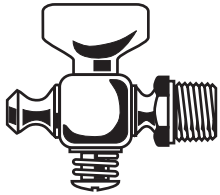

Hexagon Shoulder Tee Handle - Straight Nose

Part Number	Size	List Price
4163001	1/8"	\$5.58
4164001	1/4"	\$6.04

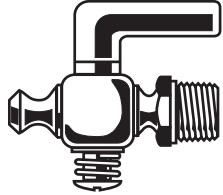

Hexagon Shoulder Lever Handle - Straight Nose

Part Number	Size	List Price
4165001	1/8"	\$5.94
4166001	1/4"	\$6.42

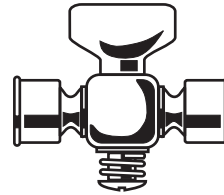

Double Female - Heavy Pattern - Tee Handle

Part Number	Size	List Price
4110201	1/4"	\$23.04

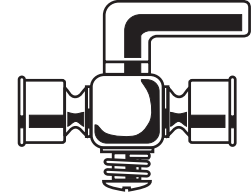

Double Female - Heavy Pattern - Lever Handle

Part Number	Size	List Price
41-103-01	1/4"	\$21.98

Gas Service Cocks

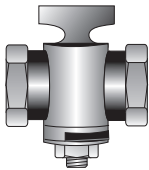

Tee Head Gas Service Cock
Nut & Washer Bottom with Check

Part Number	Size	List Price
52-101-01	1/4"	\$32.45
52-102-01	3/8"	\$32.45
52-103-01	1/2"	\$32.13
52-104-01	3/4"	\$36.53
52-105-01	1"	\$45.28

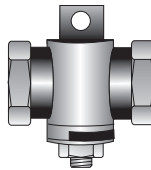

Flat Head Gas Service Cock
Nut & Washer Bottom with Check

Part Number	Size	List Price
52-201-01	1/4"	\$33.19
52-202-01	3/8"	\$33.19
52-203-01	1/2"	\$32.45
52-204-01	3/4"	\$36.53
52-205-01	1"	\$46.79

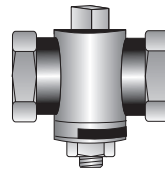

Square Head Gas Service Cock
Nut & Washer Bottom with Check

Part Number	Size	List Price
52-301-01	1/4"	\$33.64
52-302-01	3/8"	\$33.64
52-303-01	1/2"	\$32.45
52-304-01	3/4"	\$45.58
52-305-01	1"	\$45.58

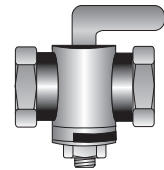

Lever Head Gas Service Cock
Nut & Washer Bottom with Check

Part Number	Size	List Price
52-401-01	1/4"	\$32.45
52-402-01	3/8"	\$32.45
52-403-01	1/2"	\$32.45
52-404-01	3/4"	\$35.98
52-405-01	1"	\$43.53

S



SHEET RUBBER

Matting With Interlocking System

Connector strips on two sides make it easy to assemble.



Black

Features:

- Material; Nitrile Black
- Elongation; 300% Minimum
- Tensile Strength; 200 psi
- Hardness; 60 Duro



Red

Features:

- Material; SBR Red
- Elongation; 300% Minimum
- Tensile Strength; 200 psi
- Hardness; 60 Duro



Part Number	Length	Size Width Thickness	Weight	List Price	Part Number	Length	Size Width Thickness	Weight	List Price
Blackmat-3X3	3'	3' 5/8"	16 lbs.	\$51.91	Redmat-3X3	3'	3' 5/8"	16 lbs.	\$75.19

Cloth Insert Neoprene

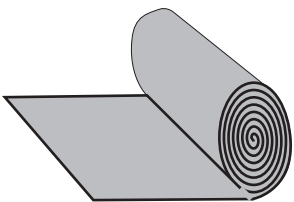
 <p>* 60 Durometer ± 5 * Elongation MIN 250% * Tensile Strength MIN 435 psi</p>	Part Number	Description	Avg. Length (Feet/Roll)	Approx. Wt. (Pounds/Roll)	List Price per Foot
	CI-NE-2	1/16" X 48" 3oz cotton 1ply	150	295.5	\$6.08
	CI-NE-4	1/8" X 48" 3oz cotton 1ply	75	294.75	\$9.81
	CI-NE-8	1/4" X 48" 3oz cotton 1ply	37	288.97	\$18.25

Nitrile Sheet BUNA-N Black

<p>General Properties *Excellent resistance to petroleum based fluids. Good physical properties. * ASTM designation: NBR * Common Name: Buna N * Polymer: Nitrile-butadiene</p> <p>* 60 Durometer ± 5 * Elongation MIN 300% * Tensile Strength MIN 435 psi</p>	Part Number	Description	Avg. Length (Feet/Roll)	Approx. Wt. (Pounds/Roll)	List Price per Foot
	CO-NIT-2-36	1/16" X 36" BUNA-N	68	100	\$3.49
	CO-NIT-4-36	1/8" X 36" BUNA-N	34	100	\$6.98
	CO-NIT-6-36	3/16" X 36" BUNA-N	45	200	\$10.47
	CO-NIT-8-36	1/4" X 36" BUNA-N	34	200	\$13.94
	CO-NIT-12-36	3/8" X 36" BUNA-N	23	200	\$20.85
	CO-NIT-16-36	1/2" X 36" BUNA-N	17	200	\$28.02

Information supplied from RMA Sheet Rubber Handbook



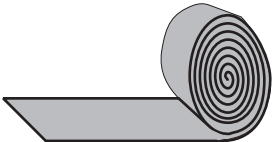

Skirtboard Specific Width

	Part Number	Description	Avg. Length (Feet/Roll)	Approx. Wt. (Pounds/Roll)	List Price per Foot
	 <p>* 60 Durometer ± 5 * Elongation MIN 400% * Tensile Strength MIN 435 psi</p>	140360	1/4" X 3"	50	20.5
140460		1/4" X 4"	50	27	\$1.08
140560		1/4" X 5"	50	34	\$1.36
140660		1/4" X 6"	50	40.5	\$1.66
140860		1/4" X 8"	50	54	\$2.74
141060		1/4" X 10"	50	67.5	\$3.26
141260		1/4" X 12"	50	81.5	\$3.30
380360		3/8" X 3"	50	30.5	\$1.21
380460		3/8" X 4"	50	40.5	\$1.66
380560		3/8" X 5"	50	50.5	\$2.04
380660		3/8" X 6"	50	61	\$2.45
380860		3/8" X 8"	50	81	\$3.25
381060		3/8" X 10"	50	101.5	\$4.09
381260		3/8" X 12"	50	121.5	\$4.92
120460		1/2" X 4"	50	54	\$2.21
120560		1/2" X 5"	50	67.5	\$2.77
120660		1/2" X 6"	50	81.5	\$3.30
120860		1/2" X 8"	50	108.5	\$4.34
121060		1/2" X 10"	50	135.5	\$5.47
121260		1/2" X 12"	50	162.5	\$6.51
340360		3/4" X 3"	50	61	\$2.45
340660		3/4" X 6"	50	122	\$4.96
340860		3/4" X 8"	50	162.5	\$6.51
341060		3/4" X 10"	50	203	\$8.21
100660		1" X 6"	50	162.5	\$6.51
100860		1" X 8"	50	217	\$8.77
101060		1" X 10"	50	271	\$10.85
101260		1" X 12"	50	325.5	\$13.08
151060		1-1/2" X 10"	50	406.5	\$16.32

Corrugated Runner Matting

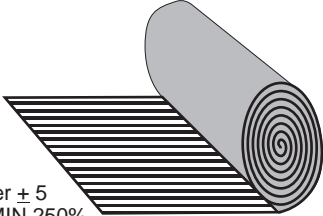
	Part Number	Description	Avg. Length (Feet/Roll)	Approx. Wt. (Pounds/Roll)	List Price per Foot
	<p>Black rubber matting for general purpose use.</p>  <p>* 70 Durometer ± 5 * Elongation MIN 250% * Tensile Strength MIN 435 psi.</p>	F-4-36	Fine Ribbed 1/8" X 36"	75	171
F-4-48		Fine Ribbed 1/8" X 48"	75	211.5	\$5.49
M-4-36		Flat Ribbed 1/8" X 36"	75	171	\$4.38
M-4-48		Flat Ribbed 1/8" X 48"	75	211.5	\$5.87

Information supplied from RMA Sheet Rubber Handbook

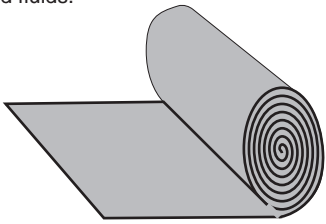

Red SBR Sheet

<p>General Properties: Good physical properties and abrasion resistance. Poor resistance to petroleum-based fluids.</p>  <p>* Composition: Styrene-butadiene * 65 Durometer \pm 5 * Elongation MIN 200% * Tensile Strength MIN 400 psi</p>	Part Number	Description	Avg. Length (Feet/Roll)	Approx. Wt. (Pounds/Roll)	List Price per Foot
	RD-SBR-2-36	1/16" X 36" Red SBR	60	100	\$4.11
	RD-SBR-4-36	1/8" X 36" Red SBR	30	100	\$8.25
	RD-SBR-6-36	3/16" X 36" Red SBR	45	200	\$12.38
	RD-SBR-8-36	1/4" X 36" Red SBR	30	200	\$16.53
	RD-SBR-2-48	1/16" X 48" Red SBR	45	100	\$5.47
	RD-SBR-4-48	1/8" X 48" Red SBR	22.5	100	\$10.75
	RD-SBR-6-48	3/16" X 48" Red SBR	34	200	\$16.51
	RD-SBR-8-48	1/4" X 48" Red SBR	22.5	200	\$21.51

Black SBR Sheet

<p>General Properties: Good physical properties and abrasion resistance. Poor resistance to petroleum-based fluids.</p> <p>* Composition: Styrene-butadiene * 60 Durometer \pm 5 * Elongation MIN 300% * Tensile Strength MIN 500 psi</p>	Part Number	Description	Avg. Length (Feet/Roll)	Approx. Wt. (Pounds/Roll)	List Price per Foot
	BK-SBR-2-48	1/16" X 48" Black SBR	45	88.5	\$2.83
	BK-SBR-4-48	1/8" X 48" Black SBR	22.5	88.5	\$5.66
	BK-SBR-6-48	3/16" X 48" Black SBR	34	200	\$8.49
	BK-SBR-8-48	1/4" X 48" Black SBR	22.5	177	\$11.28

Pure Gum Sheet Tan

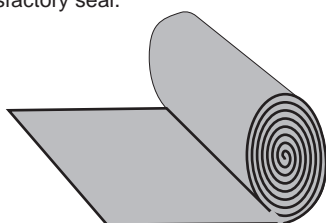
<p>General Properties: Pure gum is a composition containing a high percentage of rubber and a minimum of other ingredients to produce vulcanization. It is generally recommended for use against hot and cold water. It is particularly suited for applications where a soft rubber seal is necessary because applied pressure may be light to effect a satisfactory seal.</p>  <p>* 40 Durometer \pm 5 * Elongation @ Break 600% * Tensile Strength MIN 200Kgs/Cm² * Specific Gravity 0.96 \pm 0.05</p>	Part Number	Description	Avg. Length (Feet/Roll)	Approx. Wt. (Pounds/Roll)	List Price per Foot
	PU-GUM-4-36	1/8" X 36" Pure Gum	45/53	100	\$
	PU-GUM-6-36	3/16" X 36" Pure Gum	71	200	\$
	PU-GUM-8-36	1/4" X 36" Pure Gum	45/53	200	\$
	PU-GUM-12-36	3/8" X 36" Pure Gum	30/35	200	\$
	PU-GUM-16-36	1/2" X 36" Pure Gum	27/22	200	\$
	PU-GUM-24-36	3/4" X 36" Pure Gum	18/21	200	\$
	PU-GUM-32-36	1" X 36" Pure Gum	13/21	200	\$
	PU-GUM-4-48	1/8" X 48" Pure Gum	40	100	\$
	PU-GUM-8-48	1/4" X 48" Pure Gum	34/40	200	\$
	PU-GUM-12-48	3/8" X 48" Pure Gum	13/22	100	\$
	PU-GUM-16-48	1/2" X 48" Pure Gum	22/27	275	\$

Information supplied from RMA Sheet Rubber Handbook





Commercial Grade Black Neoprene

All rolls come with poly slip liner.

General Properties:

- * Good weather resistance
- * Flame retarding
- * Moderate oil resistance to petroleum based fluids
- * Good physical properties
- * ASTM designation: CR
- * Common Name: Neoprene
- * Polymer: chloroprene
- * Tensile strength 435 psi



- * 50 Durometer \pm 5
- * Elongation MIN 350%

- * 60 Durometer \pm 5
- * Elongation MIN 350%

- * 70 Durometer \pm 5
- * Elongation MIN 350%

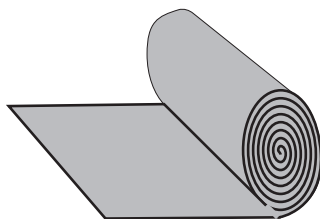

50 Durometer

Part Number	Description	Avg. Length (Feet/Roll)	Approx. Wt. (Pounds/Roll)	List Price per Foot
CO-NE50-2	1/16" X 48" Neoprene	54	100	\$5.53
CO-NE50-4	1/8" X 48" Neoprene	27	100	\$11.17
CO-NE50-6	3/16" X 48" Neoprene	36	200	\$16.75
CO-NE50-8	1/4" X 48" Neoprene	27	200	\$21.94

60 Durometer

Part Number	Description	Avg. Length (Feet/Roll)	Approx. Wt. (Pounds/Roll)	List Price per Foot
CO-NE60-1-36	1/32" X 36" Neoprene	135	100	\$2.64
CO-NE60-2-36	1/16" X 36" Neoprene	72	100	\$3.30
CO-NE60-3-36	3/32" X 36" Neoprene	48	100	\$4.96
CO-NE60-4-36	1/8" X 36" Neoprene	36	100	\$6.58
CO-NE60-6-36	3/16" X 36" Neoprene	48	200	\$9.96
CO-NE60-8-36	1/4" X 36" Neoprene	36	200	\$13.21
CO-NE60-12-36	3/8" X 36" Neoprene	24	200	\$19.91
CO-NE60-16-36	1/2" X 36" Neoprene	15	200	\$26.40
CO-NE60-24-36	3/4" X 36" Neoprene	21	351	\$29.34
CO-NE60-32-36	1" X 36" Neoprene	21	468	\$52.74
CO-NE60-2-48	1/16" X 48" Neoprene	54	100	\$4.43
CO-NE60-4-48	1/8" X 48" Neoprene	27	100	\$8.87
CO-NE60-6-48	3/16" X 48" Neoprene	36	200	\$13.40
CO-NE60-8-48	1/4" X 48" Neoprene	27	200	\$17.55
CO-NE60-12-48	3/8" X 48" Neoprene	18	200	\$26.60
CO-NE60-16-48	1/2" X 48" Neoprene	13	200	\$35.21
CO-NE60-24-48	3/4" X 48" Neoprene	21	468	\$53.02
CO-NE60-32-48	1" X 48" Neoprene	21	624	\$70.11

70 Duro Commercial Neoprene

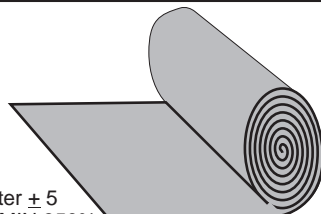

- * 70 Durometer \pm 5
- * Elongation MIN 350%
- * Tensile Strength MIN 435 psi

Part Number	Description	Avg. Length (Feet/Roll)	Approx. Wt. (Pounds/Roll)	List Price per Foot
CO-NE70-2-36	1/16" X 36" Neoprene	72	100	\$3.30
CO-NE70-4-36	1/8" X 36" Neoprene	36	100	\$6.60
CO-NE70-6-36	3/16" X 36" Neoprene	48	200	\$9.85
CO-NE70-8-36	1/4" X 36" Neoprene	36	200	\$13.09

Information supplied from RMA Sheet Rubber Handbook

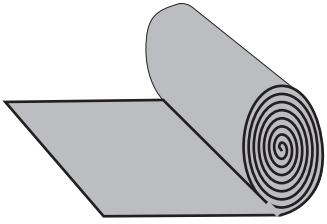

Commercial Grade Black Neoprene

		70 Durometer				
		Part Number	Description	Avg. Length (Feet/Roll)	Approx. Wt. (Pounds/Roll)	List Price per Foot
* 70 Durometer \pm 5 * Elongation MIN 350% * Tensile Strength MIN 435 psi		CO-NE70-2-48	1/16" X 48" Neoprene	54	100	\$4.43
		CO-NE70-4-48	1/8" X 48" Neoprene	27	100	\$8.87
		CO-NE70-6-48	3/16" X 48" Neoprene	36	200	\$13.36
		CO-NE70-8-48	1/4" X 48" Neoprene	27	200	\$17.75

Commercial EPDM Sheet - Black

General Properties: Excellent ozone, chemical, and aging resistance. Poor resistance to petroleum-based fluids. * Polymer: Ethylene-propylene-diene * 60 Durometer \pm 5 * Elongation MIN 300% * Tensile Strength MIN 800 psi	Part Number	Description	Avg. Length (Feet/Roll)	Approx. Wt. (Pounds/Roll)	List Price per Foot
	CO-EPDM-2	1/16" X 48" EPDM	56	100	\$4.75
	CO-EPDM-4	1/8" X 48" EPDM	29	100	\$9.53
	CO-EPDM-8	1/4" X 48" EPDM	29	200	\$18.81

White Nitrile Sheet FDA

General Properties: Excellent resistance to petroleum based fluids. Good physical properties. Food grade. * Polymer: Nitrile-butadiene * Common name: Buna N * 60 Durometer \pm 5 * Elongation MIN 650% * Tensile Strength MIN 1200 psi	Part Number	Description	Avg. Length (Feet/Roll)	Approx. Wt. (Pounds/Roll)	List Price per Foot
	WH-FDA-2-48	1/16" X 48" White FDA	60	100	\$10.85
	WH-FDA-4-48	1/8" X 48" White FDA	30	100	\$21.57
	WH-FDA-8-48	1/4" X 48" White FDA	30	200	\$43.09

Nylon Inserted SBR Sheet - Black

General Properties: Good physical properties and abrasion resistance. Poor resistance to petroleum-based fluids. * Polymer: Styrene-butadiene * 65 Durometer \pm 5 * Tensile Strength MIN 500 psi	Part Number	Description	Avg. Length (Feet/Roll)	Approx. Wt. (Pounds/Roll)	List Price per Foot
	NI-SBR-2	1/16" X 48" Nylon SBR	54	167	\$7.02
	NI-SBR-4	1/8" X 48" Nylon SBR	27	106.3	\$9.34
	NI-SBR-6	3/16" X 48" Nylon SBR	36	212.5	\$12.25
	NI-SBR-8	1/4" X 48" Nylon SBR	27	212.5	\$15.21

Information supplied from RMA Sheet Rubber Handbook





**TABLE 5-1
CORROSION RESISTANCE OF COUPLING MATERIALS**

CAUTION: The following data has been compiled from generally available sources and should not be relied upon without consulting and following the specific recommendations of the manufacturer regarding particular coupling materials.

- RATINGS:** 1. Excellent
2. Good
3. Fair or conditional
x. Not Satisfactory

NOTE: No rating indicates no data available

AGENT	Mall. From Steel	Brass	Bronze	Aluminum	Glass	Stainless 410, 416, 430	Stainless 302, 202, 304, 308	Stainless 316	Monel
Acetate, Solvents, Crude.....		3				2	1	1	2
Acetate, Solvents, Pure.....		1	1	1		1	1	1	1
Acetic Acid.....	X	X	X	2	1	X	2	2	2
Acetic Acid Vapors.....	X	X		3		X	2	2	3
Acetic Anhydride.....	X	X		2		X	2	2	2
Acetone.....	1	1	1	1	1	1	1	1	1
Acetylene.....	1	2		1		1	1	1	2
Alcohols.....	1	2		1		1	1	1	1
Aluminum Sulfate.....	X	3	3	3	1	X	3	2	2
Alums.....	X	3	2	3	1	X	3	2	2
Ammonia Gas.....	1	X	3	1	3	1	1	1	X
Ammonium Chloride.....	1	3		1*		3	3	1	1
Ammonium Hydroxide.....	2	X		2		1	1	1	3
Ammonium Nitrate.....	1	X		2		1	1	1	3
Ammonium Phosphate (Ammoniacal).....		X				1	1	1	2
Ammonium Phosphate (Neutral).....		3				1	1	1	2
Ammonium Phosphate (Acid).....		3				3	2	1	2
Ammonium Sulfate.....	1	3				2	1	1	2
Asphalt.....	1	2				2	1	1	1
Beer.....	2	2	1	1		X	1	1	1
Beet Sugar Liquors.....	1	2		1		2	1	1	1
Benzene, Benzol.....	1	1	1	1	1	1	1	1	1
Benzine (petroleum-naphtha).....	1	1		1		1	1	1	1
Borax.....	2	2				1	1	1	1
Boric Acid.....	X	3		1		3	2	1	1
Butane, Butylene.....	1	1	1	1		1	1	1	1
Butadiene.....		1				1	1	1	1
Calcium Bisulfate.....		X				X	2	1	X
Calcium Hypochlorite.....	3	3	3	X	3	X	3	2	3
Cane Sugar Liquors.....	1	2		1		2	1	1	1
Carbon Dioxide (Dry).....	1	1		1		1	1	1	1
Carbon Dioxide (Wet & Aqueous Sol).....	2	3		2		2	1	1	2
Carbon Disulfide.....	2	3		2		2	1	1	3
Carbon Tetrachloride.....	3	1	2	3	1	1	1	1	1
Chlorine (Dry).....	2	2	2	1	2	2	2	2	1
Chlorine (Wet).....	X	X	3	X	2	X	X	3	3
Chromic Acid.....		X	X	X	1	3	2	2	3
Citric Acid.....	X	3		1		3	X	1	2
Coke Oven Gas.....	1	3		2		1	1	1	2
Copper Sulfate.....	X	X		X		1	1	1	3
Core Oils.....		1	1			1	1	1	1
Cottonseed Oil.....	1	1	1	1		1	1	1	1
Creosote.....	2	3		1		1	1	1	1

*3 to X at high temperatures.

Chemical Chart is reprinted from 1996 RMA Hose Handbook



TABLE 5-1 (Continued)
CORROSION RESISTANCE OF COUPLING MATERIALS

CAUTION: The following data has been compiled from generally available sources and should not be relied upon without consulting and following the specific recommendations of the manufacturer regarding particular coupling materials.

RATINGS: 1. Excellent
2. Good
3. Fair or conditional
x. Not Satisfactory

NOTE: No rating indicates no data available

AGENT	Mall. From Steel	Brass	Bronze	Aluminum	Glass	Stainless 410, 416, 430	Stainless 302, 202, 304, 308	Stainless 316	Monel
Ethers.....	2	1		1		1	1	1	1
Ethylene Glycol.....	2	2				1	1	1	1
Ferric Chloride.....	X	X	X	X	1	X	X	X	X
Ferric Sulfate.....	X	X		X		1	1	1	3
Formaldehyde.....	2	2		2		1	1	1	1
Formic Acid.....	X	2		X		X	2	1	2
Freon.....	3	1	1	1		1	1	1	1
Furfural.....	1	2		1		1	1	1	1
Gasoline (Sour).....	3	3		3		3	1	1	X
Gasoline (Refined).....	1	1	1	1		1	1	1	1
Gelatin.....	1	3		1		1	1	1	1
Glucose.....	1	1		1		1	1	1	1
Glue.....	1	3		1		1	1	1	1
Glycerine or Glycerol.....	1	2		1		1	1	1	1
Hydrochloric Acid.....	X	X	X	X	1	X	X	X	X
Hydrocyanic Acid.....	3	X		1		3	1	1	2
Hydrofluoric Acid.....	X	3	3	X	X	X	X	X	1
Hydrogen Fluoride.....		3				X	X	3	1
Hydrogen.....	1	1		1		1	1	1	1
Hydrogen Peroxide.....	X	X		1		1	2	1	2
Hydrogen Sulfide (Dry).....	3	3		2		3	2	1	3
Hydrogen Sulfide (Wet).....	3	3		2		3	2	1	3
Lacquers and Lacquer Solvents.....	3	2		1		1	1	1	1
Lactic Acid.....	X			3			3	2	1
Lime-Sulfur.....	2	X		2		1	1	2	
Linseed Oil.....	1	1		1			1	1	1
Magnesium Chloride.....	3	3		X		3	2	1	1
Magnesium Hydroxide.....	1	2		X		1	1	1	1
Magnesium Sulfate.....	2	2		3		1	1	1	1
Mercuric Chloride.....	3	X		X		X	X	3	X
Mercury.....	1	X		X		1	1	1	2
Milk.....	3	3		1		2	1	1	3
Molasses.....	2	X		2		2	1	1	1
Natural Gas.....	1	2		1		1	1	1	1
Nickel Chloride.....		X		X		X	3	2	2
Nickel Sulfate.....		3		X		3	2	1	1
Nitric Acid.....	X	X	X	3	1	2	2	2	X
Oleic Acid.....	2	3		1		2	2	1	1
Oxalic Acid.....	3	3		2		3	2	1	1
Oxygen.....	1	1	1	1		1	1	1	1
Palmitic Acid.....	1	3		1		2	2	1	1
Petroleum Oils (Sour).....		3				3	1	1	X
Petroleum Oils (Refined).....	1	1	1	1		1	1	1	1
Phosphoric Acid 25%.....	3	X		3	3	X	3	1	2
Phosphoric Acid 25-50%.....	X	X		X	3	X	X	2	2

Chemical Chart is reprinted from 1996 RMA Hose Handbook



TABLE 5-1 (Continued)
CORROSION RESISTANCE OF COUPLING MATERIALS

CAUTION: The following data has been compiled from generally available sources and should not be relied upon without consulting and following the specific recommendations of the manufacturer regarding particular coupling materials.

RATINGS: 1. Excellent
2. Good
3. Fair or conditional
x. Not Satisfactory

NOTE: No rating indicates no data available

AGENT	Mall. From Steel	Brass	Bronze	Aluminum	Glass	Stainless 410, 416, 430	Stainless 302, 202, 304, 308	Stainless 316	Monel
Phosphoric Acid 50-85%.....	X	X		X	X	X	2	2	
Picric Acid	3	X		3		2	1	1	X
Potassium Chloride	2	3		3		3	2	1	1
Potassium Hydroxide	3	X		X		1	1	1	1
Potassium Sulfate	2	2		1		1	1	1	1
Propane	1	1				1	1	1	1
Rosin (Dark).....	1	2			1	1	1	1	1
Rosin (Light).....		X		1		1	1	1	2
Shellac.....		2		2		1	1	1	1
Sludge Acid.....		X				X	X	3	2
Soda Ash (Sodium Carbonate).....	1	2		X		1	1	1	1
Sodium Bicarbonate.....	3	1		X		1	1	1	1
Sodium Bisulfate.....	X	3		3		X	1	1	1
Sodium Chloride.....	2	3	2	X	1	3	2	1	1
Sodium Cyanide.....	2	X		X		1	1	1	2
Sodium Hydroxide.....	3	X	3	X	X	2	2	2	1
Sodium Hypochlorite.....	X	X		X		X	3	2	3
Sodium Metaphosphate.....	X	3		1		2	1	1	1
Sodium Nitrate.....	1	3		1		1	1	1	1
Sodium Perborate.....	3	3		1		1	1	1	1
Sodium Peroxide.....	3	3		1		1	1	1	1
Sodium Phosphate (Alkaline).....			3			1	1	1	1
(Neutral).....		2				1	1	1	1
(Acid).....		2				X	2	1	1
Sodium Silicate.....	1	3		X		1	1	1	1
Sodium Sulfate.....	1	2		3		1	1	1	1
Sodium Sulfide.....	1	X				1	1	1	2
Sodium Thiosulfate (Hypo).....	3	X		X		1	1	1	2
Stearic Acid.....	3	3		3		2	2	1	1
Sulfate Liquors.....		X				1	1	1	2
Sulfur.....	2	X		2		2	2	1	3
Sulfur Chloride.....	X	X				X	3	2	2
Sulfur Dioxide (Dry).....	2	1		1		1	1	1	1
Sulfur Dioxide (Wet).....		X				X	2	1	X
Sulfuric Acid 10%.....	X	X	3	3		X	X	2	2
Sulfuric Acid 10-75%.....	X	X	X	X		X	X	X	2
Sulfuric Acid 75-95%.....	3	X	X	X		3	3	2	3
Sulfuric Acid 95%.....	2	X	X			2	2	2	X
Sulfurous Acid.....	X	X		X		X	3	2	X
Tannic Acid.....	3	3	1	X		1	1	1	1
Tar.....	1	2		1		2	1	1	1
Toluene, Toluol.....	1	1		1		1	1	1	1
Trichlorethylene.....	3	1		3		1	1	1	1

Chemical Chart is reprinted from 1996 RMA Hose Handbook



TABLE 5-1 (Continued)
CORROSION RESISTANCE OF COUPLING MATERIALS

CAUTION: The following data has been compiled from generally available sources and should not be relied upon without consulting and following the specific recommendations of the manufacturer regarding particular coupling materials.

RATINGS: 1. Excellent
 2. Good
 3. Fair or conditional
 x. Not Satisfactory

NOTE: No rating indicates no data available

AGENT	Mall. From Steel	Brass	Bronze	Aluminum	Glass	Stainless 410, 416, 430	Stainless 302, 202, 304, 308	Stainless 316	Monel
Turpentine.....		3		1		3	1	1	1
Varnish.....	2	2				1	1	1	1
Vegetable Oils.....	1	2		1		1	1	1	1
Vinegar.....	3	3		3		3	2	1	2
Water (Acid Mine Water).....	3	X		3		2	1	1	3
Water (Fresh).....	3	1		1		1	1	1	1
Water (Salt).....	3	3	2	X		3	2	2	1
Whiskey.....	X	2				3	1	1	2
Wines.....	X	2				3	1	1	2
Xylene, Xylol.....	2	1		1		1	1	1	1
Zinc Chloride.....	X	X		X		3	2	1	1
Zinc Sulfate.....	3	3		3		3	2	1	1

Chemical Chart is reprinted from 1996 RMA Hose Handbook



OIL AND GASOLINE RESISTANCE

Rubber hose is used to convey petroleum products both in the crude and refined stages. The aromatic content of refined gasoline is often adjusted to control the octane rating. The presence of aromatic hydrocarbons in this fuel generally has a greater effect on rubber components than do aliphatic hydrocarbons. Aromatic materials in contact with rubber tend to soften it and reduce its physical properties. For long lasting service, the buyer of gasoline hose should inform the hose manufacturer of the aromatic content of the fuel to be handled so that the proper tube compound can be recommended for the specific application.

The effects of oil on rubber depend on a number of factors that include the type of rubber compound, the composition of the oil, the temperature and time of exposure. Rubber compounds can be classified as to their degree of oil resistance based on their physical properties after exposure to a standard test fluid. In this RMA classification, the rubber samples are immersed in IRM 903 oil at 100°C for 70 hours. (See ASTM Method D-471 for a detailed description of the oil and the testing procedure.) As a guide to the user of hose in contact with oil, the oil resistance classes and a corresponding description are listed.

Physical Properties After Exposure to Oil

	Volume Change Maximum	Tensile Strength Retained
Class A (High oil resistance).....	+25%	80%
Class B (Medium/high oil resistance).....	+65%	50%
Class C (Medium oil resistance).....	+100%	40%

Information supplied from RMA Hose Handbook



CHEMICAL RECOMMENDATIONS

The materials being handled by flexible rubber hose are constantly increasing in number and diversity. To assist in the selection of the proper elastomer for the service conditions encountered, the following table has been prepared. The reader is cautioned that it is only a guide and should be used as such, as the degree of resistance of an elastomer with a particular fluid depends upon such variables as temperature, concentration, pressure, velocity of flow, duration of exposure, aeration, stability of the fluid, etc. Also variations in elastomer types and special compounding of stocks to meet specific service conditions have considerable influence on the results obtained. When in doubt, it is always advisable to test the tube compound under actual service conditions. If this is not practical, tests should be devised that simulate service conditions or the hose manufacturer contacted for Recommendations.

The following table lists the more commonly used materials, chemicals, solvents, oils, etc. The recommendation are based on room temperature and pressure conditions normally recommended for the particular type of hose being used. Where conditions beyond this can be met readily, they have been so indicated; where conditions are not normal and cannot be readily met, the hose manufacturer should always be consulted. The table does not imply conformance to the Food & Drug Administration requirements of Federal or State Laws when handling food products.

TABLE OF CHEMICAL, OIL AND SOLVENT RESISTANCE OF HOSE

WARNING: The following data has been compiled from generally available sources and should not be relied upon without consulting and following the hose manufacturer's specific chemical recommendations. Neglecting to do so might result in failure of the hose to fulfill its intended purpose, and may result in possible damage to property and serious bodily injury.

Resistance Rating

- A** - Good Resistance, usually suitable for service.
- F** - Fair Resistance, the chemical has some deteriorative effects, but the elastomer is still adequate for moderate service.
- C** - Depends on Condition, moderate service may be possible if chemical exposure is limited or infrequent.
- X** - Not recommended, unsuitable for Service,
- I** - Insufficient Information, not enough data available at the time of publication to determine rating.

- NR** Natural Rubber
- IR** Isoprene, synthetic
- SBR** Styrene-butadiene
- CR** Chloroprene
- NBR** Nitrile-butadiene
- IIR** Isobutene-isoprene
- CSM** Chloro-sulfonyl-polyethylene

Elastomers/Plastics

- EPDM** Ethylene-propylene-diene-terpolymer
- MQ** Dimethyl-polysiloxane
- FKM** Fluorocarbon rubber
- CM** Chloro-polyethylene
- ECO/CO** Ephichlorohydrin
- XLPE** Cross-linked polyethylene



Commonly used Elastomers

Special Elastomers

Material	NR lor IR	SBR	CR	NBR	IIR	CSM	EPDM	MQ	FKM	ECO		
										CM	CO	XLPE
(Maximum Temperature 100° F (38°C) Unless Otherwise Specified)												
Acetic Acid, Dilute, 10%	F	C	C	C	A	C	A	A	X	A	F	A
Glacial	C	X	X	X	F	C	F	F	X	A	X	A
Anhydride	C	C	F	F	F	A	I	C	X	A	X	A
Acetone	A	A	F	X	A	F	A	A	X	A	X	A
Acetylene	A	A	F	A	A	F	A	C	A	I	I	A
Air	150°F (65°C)	A	A	A	A	A	A	A		A	A	A
Aluminum Chloride	150°F (65°C)	A	A	A	A	A	A	A	A	A	A	A
Aluminum Fluoride	150°F (65°C)	A	A	A	A	A	A	F			A	A
Aluminum Sulfate	150°F (65°C)	A	A	A	A	A	A	A	A	A	I	A
Alums	150°F (65°C)	A	A	A	A	A	A	A		A	I	A
Ammonia Gas		A	A	A	A	A	A	A	X	A	I	A
Ammonium Chloride		A	A	A	A	A	A	C	A	A	A	A
Ammonium Hydroxide		C	F	F	A	A	A	A	A	A	I	A
Ammonium Nitrate		A	A	A	A	A	A	A		I	A	A
Ammonium Phosphate, monobasic		A	A	A	A	A	A	A		A	I	A
dibasic		A	A	A	A	A	A	A		I	I	A
tribasic		A	A	A	A	A	A	A		I	I	A
Ammonium Sulfate		A	A	A	A	A	A	A	A	A	I	A
Amyl Acetate		F	X	X	X	F	X	A	A	X	C	X
Amyl Alcohol		A	A	A	A	A	A	A	A	A	A	A
Aniline, Aniline Oil		X	X	C	X	A	X	C	C	A	C	X
Aniline Dyes		F	F	F	F	A	F	C	C		I	I
Asphalt		X	X	F	F	X	F	X		A		X
Barium Chloride	150°C (65°C)	A	A	A	A	A	A	A	A	A	A	A
Barium Hydroxide	150°C (65°C)	A	A	A	A	A	A	A	A	A	A	A
Barium Sulfide	150°C (65°C)	A	A	A	A	A	A	A	A	A	I	A
Beer		A	A	A	A	A	A	A	A	A	I	A
Beet Sugar Liquors		A	A	A	A	A	A	A	A	A	I	A
Benzene, Benzol		X	X	X	C	X	X	X	C	A	C	X
Benzine, petroleum ether and Benzine, petroleum naphtha		X	X	C	F	X	F	X	C	A		I
Black Sulfate Liquor		A	A	A	A	A	A	A	A		I	I
Blast Furnace Gas		C	C	A	C	C	C	C	C	A	I	I
Borax		A	A	A	A	A	A	A	A	A	I	I
Boric Acid		A	A	A	A	A	A	A	A	A	I	A
Bromine		X	X	X	X	X	C	X	F	A	C	F
Butane		X	X	F	A	X	A	X	A	A	A	A
Butyl Acetate		C	X	X	X	F	X	F	A	X	F	X
Butyl alcohol ,butanol		A	A	A	A	A	A	A	A	A	F	I

Chart is reprinted from 1996 RMA Hose Handbook



Commonly used Elastomers

Special Elastomers

Material	NR Or IR	Special Elastomers										
		SBR	CR	NBR	IIR	CSM	EPDM	MQ	FKM	CM	ECO CO	XLPE
Calcium bisulfate	C	C	A	A	F	A	F	C	A	A	I	A
Calcium chloride	A	A	A	A	A	A	A	A	A	A	A	A
Calcium hydroxide	A	A	A	A	A	A	A	A	A	A	A	A
Calcium hypochlorite	X	X	X	X	A	F	A	C	A	A	F	F
Caliche liquors	A	A	A	A	A	A	A				I	A
Cane sugar liquors	A	A	A	A	A	A	A	A	A	A	A	A
Carbolic acid, phenol	C	C	C	C	C	C	A	A	A	A		A
Carbon dioxide , dry/wet	A	A	A	A	A	A	A	A	A	A	A	A
Carbon disulfide	X	X	X	X	X	X	X	C	A	C		C
Carbon monoxide 150°C (65°C)	C	C	C	C	C	F	C	A	A	I		A
Carbon tetrachloride	X	X	X	C	X	X	X	C	A	C	F	A
Castor oil	A	A	A	A	A	A	A	A	A	A	A	A
Cellosolve acetate	F	F	X	X	A		A	C	C			A
CFC-12	X	X	A	A	F		F	X	A		A	I
China wood oil, tung oil	X	X	F	A	A	F	A	A	C		I	A
Chlorine, dry/wet	X	X	X	X	X	X	X	X	C	X	X	F
Chlorinated solvents	X	X	X	X	X	X	X	C	C	C		A
Chloroacetic acid	X	C	C	C	X	A	I	C	X			A
Chlorosulfonic acid	X	X	C	C	X	X	X	C	X			F
Chromic acid	X	X	X	X	C	A	I	C	C	A		F
Citric acid	A	A	A	F	A	A	A	A	A	A	A	A
Coke oven gas	C	C	C	C	C	A		A	X	A	X	C
Copper chloride 150°F (65°C)	C	A	F	A	A	F	A	A	A	A	I	A
Copper sulfate 150°F (65°C)	C	A	A	A	F	A	A	A	A	A	A	A
Corn oil	X	C	F	A	A	F	C	A	A	A	A	A
Cottonseed oil	X	C	F	A	A	F	C	A	A	A	I	A
Creosote, coal tar	X	X	F	A	X	F	X	C	F		X	A
Wood	X	X	F	A	X		X	C	A			A
Creosols, cresylic acid	C	X	X	C	C	F	X	C		F		A
Ethers	C	C	C	C	C	F	X	C	X	A		A
Ethyl acetate	F	X	X	X	F	X	F	F	X	F	X	A
Ethyl alcohol	A	A	A	A	A	A	A	A	A	A	A	A
Ethyl cellulose	F	F	F	F	F		F	C	X	F		A
Ethyl chloride	A	F	F	X	A	F	A	C	F	F	F	F
Ethylene glycol	A	A	A	A	A	A	A	A	A	A	A	A
Ferric chloride 150°F (65°C)	A	A	A	A	A	A	A	A	I	A	A	A
Ferric Sulfate 150°F (65°C)	A	A	A	A	A	A	A	A	A	A	A	A
Formaldehyde	A	A	C	A	A	A	A	A	A	A	F	A
Formic acid	A	A	C	F	A	A	A	A	X	A	F	F
Fuel oil	X	X	A	A	X	F	X	C	A	F	A	A

Chart is reprinted from 1996 RMA Hose Handbook



Commonly used Elastomers

Special Elastomers

Material	NR Or IR	SBR	CR	NBR	IIR	CSM	EPDM	MQ	FKM	CM	Special Elastomers	
											ECO CO	XLPE
Furfural	X	C	C	X	A	F	C	C	X	A	X	A
Gasoline , Non Leaded	X	X	X	A	X	X	X		A	C	A	A
Gasoline, +MTBE	X	X	X	A	X	X	X	C	A	C	A	A
Hi-test-+MTBE	X	X	X	A	X	X	X	C	A	C	A	A
Gelatin	A	A	A	A	A	A	A	A	A		A	A
Glucose	A	A	A	A	A	A	A	A	A		A	A
Glue	F	F	A	A	F	A	A	A	C		A	A
Glycerine, glycerol	A	A	A	A	A	A	A	A	A	A	A	A
Green sulfate liquor	A	A	A	A	A	A	A	A	A	A	A	A
HFC-134A	F	X	A	A	A	F	A		X	F		A
Hydraulic fluids												
Petroleum	X	X	A	A	X	F	X			A	A	
Phosphate ester alkyl	X	X	C	X	A	X	A			A	X	
Phosphate ester arly	X	X	X	X	C	X	C			C	X	
Phosphate ester blends		X	X	X	X	X	X	C			C	X
Silicate ester	X	X	C	C	X	C	X			C	C	
Water-Glycol	A	A	A	A	A	A	A		A	A	A	
Hydrobromic acid	C	X	C	C	A	A	A	C	A	A		I
Hydrochloric acid	A	X	X	X	C	C	C	C	A	A	X	A
Hydrocyanic acid	F	F	C	F	C	A	C	A	A	A		A
Hydrofluoric acid	X	X	X	X	C	A	C	X	A	A		A
Hydrofluosilicic acid	A	F	F	F	A		A	A	A	A		I
Hydrogen Gas	F	F	A	A	A		A	A	A		A	A
Hydrogen peroxide	X	X	C	C	C	C	C	A	A	A		I
Hydrogen sulfide, dry	C	C	F	C	A	A	A	C	F			A
wet	C	C	F	C	A	A	A	C	C		F	A
Kerosene	X	X	F	A	X	C	X	C	A	A	A	A
Lacquers	X	X	X	X	C	X	X		X		X	F
Lacquers solvents	X	X	X	X	C	X	X		X		X	F
Lactic acid	C	C	C	C	C	A	C	A	A			A
Linseed oil	C	X	F	A	A	A	A	A	A	A	A	A
Lubricating oil, crude	X	X	F	A	X	C	X	C	A		A	A
refined	X	X	F	A	X	C	X	C		A	A	A
Magnesium chloride	150°F (65°C)	A	A	A	A	A	A	A	A	A	A	A
Magnesium hydroxide	150°F (65°C)	A	F	F	F	A	A	F	A	A	A	A
Magnesium sulfate	150°F (65°C)	A	A	A	A	A	A	A	A	A	A	A

Chart reprinted from 1996 RMA Hose Handbook



Commonly used Elastomers

Special Elastomers

Material	NR Or IR	SBR	CR	NBR	IIR	CSM	EPDM	MQ	FKM	CM	Special Elastomers	
											ECO CO	XLPE
Mercuric chloride	F	F	C	F	A	A	A	A	A		A	A
Mercury	A	A	A	A	A	A	A	A	A		A	A
Methyl alcohol, methanol	A	A	A	A	A	A	A	A	C	A	F	A
Methyl chloride	C	C	C	C	C	X	C	X	A			F
Methyl ethyl ketone	X	X	X	X	F	C	A	C	X	C	X	A
Methyl isopropyl ketone	X	X	X	X	F	C	C	C	X	F	X	A
MTBE												A
Milk	C	C	F	F	A	A	A	A	A	A	A	A
Mineral oils	X	C	F	A	X	F	X	A	A	A	A	A
Natural gas	C	C	A	A	C	A	X	C	A	A	A	A
Nickel chloride 150°F (65°C)	A	A	A	A	A	A	A	A	A	A	I	A
Nickel sulfate 150°F (65°C)	A	A	A	A	A	A	A	A	A	A	I	A
Nitric acid, crude	X	X	X	X	C	C	X	X	C	A	X	F
Diluted 10%	X	X	C	X	C	A	C	C	C	A	X	I
Concentrated 70%	X	X	X	X	C	C	X	X	C	X	X	F
Nitrobenzene	X	X	X	X	X	X	X	C	F	C	X	A
Oleic acid	X	F	C	F	F	F	F	A	C	A		A
Oleum spirits	X	C	C	C			I		C			I
Oxalic acid	F	C	F	F	A	A	A	A	A	A	F	A
Oxygen	F	C	A	C	A		A	A	A	A	F	A
Palmitic acid	X	F	A	A	F	F	F	C	A	A	F	A
Perchlorethylene	X	X	X	C	X	X	X	C	A	C	F	A
Petroleum oils and crude 200°F (95°C)	X	X	F	A	X	C	X	C	A	C	A	A
Phosphoric acid, crude	A	C	C	C	C	A	C	C	A	A		A
pure 45%	A	C	C	C	C	A	C	C	A	A		I
Picric acid, molten	C	C	C	C	C		I					I
water solution	A	C	F	F	A	A	I	A	A			I
Potassium chloride	A	A	A	A	A	A	A	A	A	A	A	A
Potassium cyanide	A	A	A	A	A	A	A	A	A	A	A	A
Potassium hydroxide	F	F	C	C	A	A	A	A	C	A	A	A
Potassium sulfate	A	A	A	A	A	A	A	A	A	A	A	A
Propane	X	X	F	A	X	F	X	A	A	A	A	A
Sewage	C	C	F	A	C	A	C	C	A		I	A
Soap solutions	A	A	F	A	A	A	A	A	A	A	A	A
Soda ash, sodium carbonate	A	A	A	A	A	A	A	A	A	A	A	A
Sodium bicarbonate, baking soda	A	A	A	A	A	A	A	A	A	A	A	A
Sodium bisulfate	A	A	A	A	A	A	A	A	A	A	A	A
Sodium chloride	A	A	A	A	A	A	A	A	A	A	A	A
Sodium cyanide	A	A	A	A	A	A	A	A	A	A	A	A
Sodium hydroxide	F	F	C	C	A	C	A	A	C	A	F	A
Sodium hypochlorite	X	X	X	X	A	F	A	C	A	A	F	F

Chart reprinted from 1996 RMA Hose Handbook



Commonly used Elastomers

Special Elastomers

Material	NR											
	Or IR	SBR	CR	NBR	IIR	CSM	EPDM	MQ	FKM	CM	ECO CO	XLPE
Sodium metaphosphate	A	A	C	A	A	F	A	A	A	A	I	A
Sodium nitrate	C	C	C	C	A	A	A	C	A	A	A	A
Sodium perborate	C	C	C	C	A	A	A	A	A			A
Sodium peroxide	C	C	C	C	A	A	A	C	A			A
Sodium phosphate.monobasic	A	F	C	F	A	A	A	A	A	A		A
dibasic	A	F	C	F	A	A	A	A				A
tribasic	A	F	C	F	A	A	A	A				A
Sodium silicate	A	A	A	A	A	A	A	A	A	A	I	A
Sodium sulfate	A	A	A	A	A	A	A	A	A	A	A	A
Sodium sulfide	A	A	A	A	A	A	A	A	A	A	I	A
Sodium thiosulfate, "hypo"	A	A	A	A	A	A	A	A	A	A	I	A
Soybean oil	X	C	F	A	A	A	A	A	A	A	A	A
Stannic chloride	A	A	A	A	F	A	F	A	A	A	I	A
Steam	C	C	C	C	A	A	F	C	X		X	X
Stearic acid	X	X	C	F	F	C	F	A	I		F	A
Sulfur	F	F	A	F	A	A	A	F	A		F	C
Sulfur chloride	X	X	C	C	X	A	X	C	A			A
Sulfur dioxide, dry	C	C	C	C	C	A	C	A	A		I	I
Sulfur trioxide, dry	X	C	C	C	C	F	C	A	A			I
Sulfuric acid, 10%	A	A	A	A	A	A	A	A	A	A	A	A
11%-75%	C	C	C	C	F	A	C	C	A	A	F	A
76%-95%	X	X	X	X	C	A	X	X	A	X	X	A
fuming	X	X	X	X	X	X	X	X	A	X	X	X
Sulfurous acid	C	C	C	C	C	A	C	C	A	A	C	A
Tannic acid	A	C	A	C	A	A	A	A	A	A	I	A
Tar	X	X	C	C	X	C	X	C	F		F	X
Tartaric acid	A	C	C	C	F	A	F	A	A	A	F	A
Toluene, toluol	X	X	X	C	X	X	X	C	A	C	X	A
Trichloroethylene	X	X	X	X	X	X	X	C	A	C	X	A
Turpentine	X	X	X	F	X	X	X	C	A	F	A	A
Vinegar	C	C	C	C	A	A	A	A	A	A		A
Water, acid mine	A	A	C	A	A	A	A	A	A	A	I	A
Water, fresh	A	A	C	A	A	A	A	A	A	A	A	A
distilled	A	A	C	A	A	A	A	A	A	A	A	A
Whiskey and wines	A	A	A	C	A	A	A	A	A	A	I	A
Xylene.xylol	X	X	X	C	X	X	X	C	A	X	X	A
Zinc chloride	C	C	C	C	A	A	A	A	A	A	I	A
Zinc sulfate	A	A	A	A	A	A	A	A	A	A	I	A

Information supplied from RMA Hose Handbook



Air Cocks	77, 78, 227, 228	Fire Hose	194 - 201
Air Coils	127	Fire Hose Couplings	203 - 206
Air Quick Couplings	124 - 126	Gaskets	204
Anti-Seize Compound	65 - 75, 155	Mill Hose	189 - 193
BALL VALVES		Monitors	217, 218
Brass	222	Nozzles	209 - 213
Carbon Steel	224	Spanner Wrenches	220
Flanged End	224	Valves	207, 215, 216
Gas	224	Wyes	207, 215, 216
Lead Free Brass	222	Flanges - Polypropylene	111
Polypropylene	107, 110	FOOT VALVES	58
Stainless	223	FUEL TANKER PRODUCTS	22 - 34
Stainless W/Cam Adapter	224	Fusible Pipe Caps	18
Barrel Faucets	225	Garden Hose Fittings	118, 119
Bauer Type Couplings	60 - 62	GASKETS	
Belt Dressing	72	Cam & Groove	20, 21
Bibb Faucet	225	Crowfeet	40
Blow Guns	127	FDA	21
CAM AND GROOVE	1 - 8	Fire Hose	204
BSP Adapters, Flanged	13, 19	Foot Valve	58
Gaskets	20, 21	Fuel Tanker	24
Handles, Velcro Straps	14	Sandblast	40
Lockable Caps	25, 26, 29	Shank Coupling	63
Polypropylene 90°	15	GAUGES	76, 79 - 86
Pressure Ratings	14, 20, 21	Ammonia	84
Reducing	16 - 19	Bi-Metal Thermometer	76
Self-Locking	9, 14	Compound	80 - 83
Cap and Chain	206	Heavy Duty	79
Chain	35, 38	Hydraulic	82 - 85
Check Valve	226	Liquid Filled	79, 82 - 85
CLAMPS		Panel Mount	85
Clamp Kit	94, 101	Pressure & Vacuum	80, 81
Double Bolt	64, 88	Process	86
Heavy Duty 2-Bolt	90	Snubbers	87
Hi-Torque, Constant Torque	95	Steam Gauge Siphons	87
Make-A-Clamp	101	Thermometers	76
Pinch-On	106	Grip-On Fittings	116, 117
Punch Type	97 - 100	GROUND JOINT COUPLINGS	42
Quick Release	96	HANDLES	
Spiral	64, 88	Cam and Groove	14
Strapping & Buckles	92, 99	Fuel Tanker	22
Bolt Clamps	88 - 91	Investment Stainless	14
Tools	92, 97, 98, 104	Self-Locking	14
Universal	64, 88	HOSE	
Worm Gear	93 - 95, 101, 102	Air & Water	127, 164 - 166, 186
COMBINATION NIPPLES	44 - 46	Bulk Material	174
Corrosion Resistance Chart	234 - 237	Braided	187
Crimping Sleeves	54 - 57	Cement Hose	177
Crimping Tools	123	Chemical	175, 176
CROWFOOT COUPLING	40, 41	Crude Oil Suction	170, 171
Sandblast	40	Discharge - PVC	179, 180, 183 - 185
Crowfoot w/Ferrules	41	Ducting	186
Safety Clips & Lanyards	38	Drop Hose	163, 181
Gaskets	40	Fire Hose	194 - 202
DRY-DISCONNECT		Fuel Oil Delivery	165
Aluminum	35 - 37	Garden Hose	120, 187
Polypropylene	107	Goodyear	188
Stainless	35 - 37	Hot Air Blower	177
FERRULES		Hydraulic	156 - 161
Brass	122	Mill Hose	189 - 193
Crimp Sleeves	57	Nitril PVC	179
Light Duty	56	Nylon Recoil	127
Heavy Duty	56	Oil Discharge	174
Stainless	47, 54, 55	Oil Return	160
FIRE HOSE FITTINGS & ACCESSORIES		Petroleum	163 - 175
Adapters	205, 206	Plaster, Grout & Concrete	177
Cap & Chain	206	Polyurethane Recoil Hose	127
Expansion Rings	203	Pressure Washer	156



Protective Sleeve	161	REDUCING ADAPTERS & COUPLERS	
Sandblast	178	RUBBER HOSE	15 - 19
Slinky Sleeves	163	Safety Cable	156 - 160, 162 - 163
Sludge Suction	183	Safety Chain	38
Steam	168	SANDBLAST COUPLINGS	35, 38
Suction - PVC	180 - 183	Screws	40, 178
Tank Truck	171 - 173	Self-Locking Couplers	40
Textile Air	166	SHANK COUPLING	9
Tubing	186, 187	Aluminum, Brass, Poly	40
UHMW Chemical	176	Washer	40
Water Discharge	169	Silicone Lubricant	69, 70
Water Suction	168	SHEET RUBBER	229 - 233
Wire Air	166	SHOP AIDS / SEALANTS	65 - 75
HOSE BARBS		Joint Sealant	65
Brass	43, 116	Teflon Tape	66
Polypropylene	115	Silicon Adhesive	69
Stainless	39, 43	Siphons	87
Steel	44	SKIRTBOARD	230
Hose Bend Restrictors	156	Spanners	220
Hose Cutter	104	Storz Fittings	219
HOSE MENDER		STRAINERS	58, 59, 112, 113
Brass	121, 49	Funnel Strainer	59
Polypropylene	49, 114	Pump Strainer	59
Steel	48	Threaded Sight Glass	59
Hose Reels	220	Y-Type	226
Hose Stems - Heavy Duty	47	STRAPPING & BUCKLES	92
HYDRAULIC		PTFE TAPE	66
Adapters & Couplings	128 - 155	PTFE Thread Sealant	65, 66, 72, 155
Hose	156 - 161	THERMOMETERS	76
Lanyards & Safety Clips	38	Thermowells	76
Line Strainers	112, 113	Thread Lockers	72
Male Stems	49	TOOLS	
Matting	229, 230	Clamping	92, 97, 98
NIPPLES		Crimping	92
Combination	45, 46	Replacement Parts	98
Crimp Style	46	Tubing - PVC	186, 187
Grooved	44, 46	VALVES	
Pipe	52, 53	Angle	207
Polypropylene	49	Ball	222 - 224
Reducing	45, 48	Barrel Faucet	225
Stainless	43 - 46	Butterfly	224
Steel	43, 44, 46	Check Valve	226
T.O.E.	39	Gas	224
Weld	39	Gate	225
NOZZLES		Globe	225
Fire Fighting	209, 212, 213, 217, 218	Molasses Gate	225
Fog	209	Needle	86, 87, 221
Hose Pipe	209	Polypropylene	107, 110
Polypropylene	110	Stubby Valve	107
Pipe Cap	18	Swing Check	226
POLYPROPYLENE		Vapor Recovery	25 - 33
Ball Valves	107, 110	WELD NIPPLES	39
Cam and Groove	1 - 12	Wyes	207, 208, 214 - 216, 225
Dry-Disconnect	107		
Flanges	111		
Hose Barbs	115		
Line Strainers	112, 113		
Menders	114		
Pipe Cross, Pipe Nipples	114		
Pipe Fittings	111, 114		
Reducer Bushings & Nipples	114		
PRESSURE AND TEMP RATINGS			
Pressure Washer Couplings	14, 20, 21		
Protective Sleeve	126, 156		
Pneumatic Products	161		
PVC HOSE	124 - 127		
	127, 179, 182 - 188		