



Technical Discussion: Solvent Welded Joints PVC Schedule 40 & 80



Oatey-Recommended Procedures

- Below is an overview of the general steps recommended by Oatey to join thermoplastic pipe and fittings
 - In accordance with ASTM D 2855-96(2010) Standard Practice for Making Solvent Cemented Joints with Poly (Vinyl Chloride) (PVC) Pipe and Fittings

PVC Pipe and Fittings

- Cut Pipe
- De-Burr and Bevel Pipe End
- Dry Fit Pipe and Fitting
- Clean Pipe
- Apply Primer
- Apply Solvent Cement
- Join (Pipe and Fitting)
- Cure
- Test System



Personal Protection Equipment (PPE)

- When Solvent Cementing:
 - Do not breathe vapors. Use only in well ventilated areas. If forced air ventilation is used, be sure it does not cause a fire hazard from solvent vapors. If adequate ventilation cannot be provided, wear a NIOSH-approved respirator for organic solvents.
 - Protective eye wear with side shields should be worn throughout the solvent welding process
 - Rubber or latex gloves should be worn anytime you are handling Oatey Cleaners, Primers or Solvent Cements



Suggested Tools

- Protective eye wear with side shields
- Rubber or latex gloves
- NIOSH-approved respirator for organic solvents

Step One – Pipe Cutting

- It is imperative that pipe be cut square
 - For small diameter, use a hand saw and miter box, ratchet cutters, or a wheel type cutter
- For large diameter, mark the cut by using a pipe wrap to draw a line squarely around the pipe, then use a saw appropriate for the pipe size to make a clean cut
- Any damage or cracking on the pipe should be cut off at least 2" beyond the damage
- If the pipe is not cut square, the critical area of the pipe needed for fusion is lost
- Poorly cut pipe can result in leaks or even total joint separation



Proper Technique



Suggested Tools

- Ratchet type pipe cutters
- Mechanical / fine-tooth saw
- Miter box
- Wheel type pipe cutter
- Cut off/Chop Saw

Step Two – De-Burring and Beveling

- Remove all burrs on pipe from the inside and outside edges
 - Burrs on the outside diameter can create leak paths
 - Burrs on the inside diameter can clog flow or create vibrations
- Bevel (chamfer) the end of the pipe 10 to 15 degrees
 - Prevents pushing solvent cement to the bottom of the fitting socket

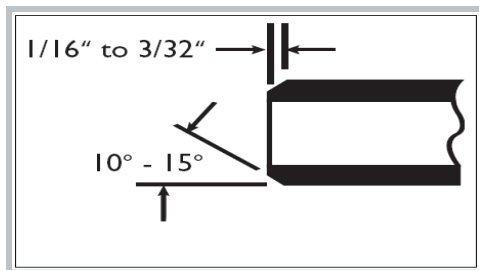

Proper Technique

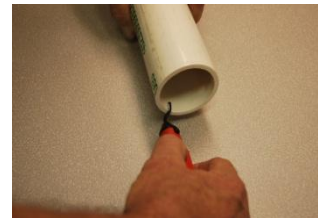

Suggested Tools

- Knife edge
- Files
- Cone beveller (hand or power)

Step Three – Dry Fit Check

- Dry fit to check the interference fit of the pipe and fitting
- For a proper interference fit, the pipe should make contact with the socket wall 1/3 to 2/3 of the way into the fitting socket
- Pipe and fittings that are too loose or too tight when dry fit, should not be used
- Measure the fitting socket depth and mark this distance on the pipe OD
 - Add two inches to the fitting socket depth and make a witness mark on the pipe, as the primer and solvent cement will remove the first mark
 - ♦ The witness mark will be used to ensure the pipe is fully inserted into the fitting and did not creep out during cure

Proper Technique

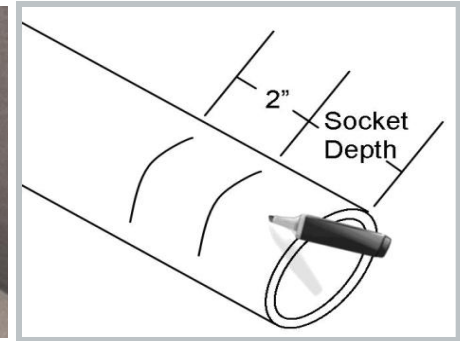

Suggested Tools

- Marker
- Tape Measure or Ruler

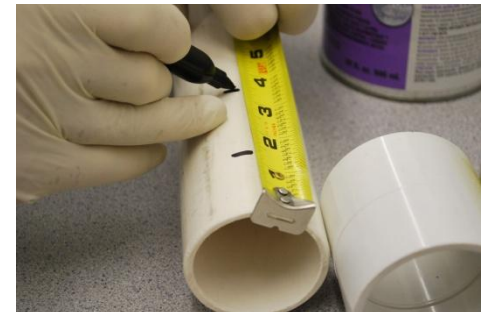

Step Four – Cleaning

- Remove all surface dirt, grease and moisture
 - Foreign material will impede the bond between pipe and fitting and can create leak paths
 - Moisture will negatively impact the curing process
- Oatey recommends the use of a clean dry cloth and then an application of Oatey Clear Cleaner

Proper Technique



Suggested Tools

- Oatey Cleaner
- Clean, dry cloth



Step Five – Applying Primer⁽¹⁾

- Role of primer:
 - Pre-softens the surfaces of the pipe and fitting to achieve maximum fusion
- Using an applicator one-half the size of the pipe diameter, aggressively work the primer into the fitting socket
 - Re-dip the applicator in the primer as required
 - You will feel the dauber start to drag when the surface is being broken down by the primer
 - Once primed, remove any puddles of primer from the socket using the applicator
- Once the fitting socket has been primed, aggressively work the primer around the end of the pipe to a depth of about 1/2" beyond the socket depth
- Apply a second coat of primer to the fitting socket
- Immediately, while both surfaces are still wet, begin the solvent cementing process that follows

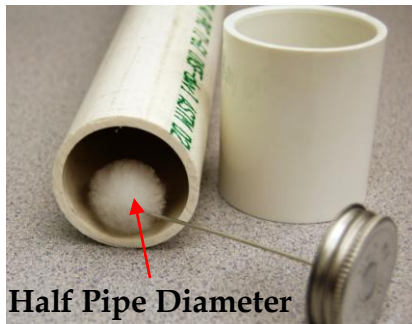

Half Pipe Diameter

Proper Technique

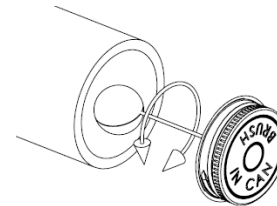
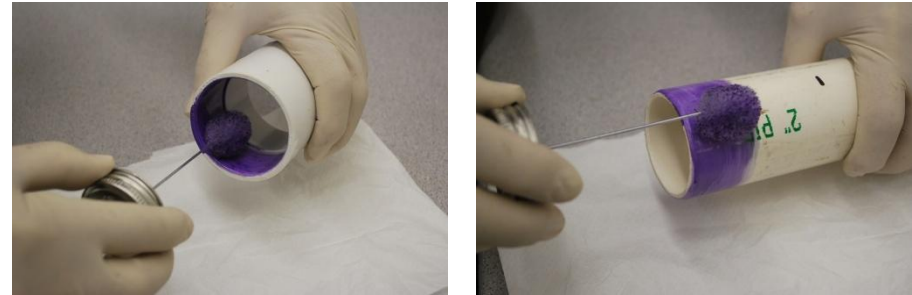

Fitting

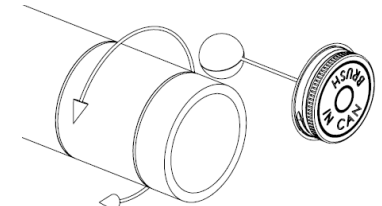

Pipe

Suggested Tools

- Listed Oatey Primer (Purple or Clear)
ASTM F 656
- Oatey Industrial Grade Primer (Purple or Clear)
ASTM F 656

(1) Note – Do not use primer on ABS pipe/fittings

Step Six – Applying Solvent Cement



- Before purchase and use of a product, review the product application and be certain the product, installation and use will be in compliance with any applicable codes and regulations
- Shake cement can before using
 - Do not use cement that has jelled
- The solvent cement is to be applied when the pipe and fitting are clean and free of any moisture and debris and must be applied immediately while primer is still wet
 - Using an applicator one-half the size of the pipe diameter, aggressively work a heavy, even layer of cement onto the pipe end equal to the depth of the fitting socket
- Without re-dipping the applicator in the cement, aggressively work a thin coat of cement into the fitting socket
 - Avoid puddling of the cement in the fitting socket
- Re-dip applicator and apply a second full, even layer of cement on the pipe
- Always verify code requirements for acceptable solvent cement and primer

Proper Technique

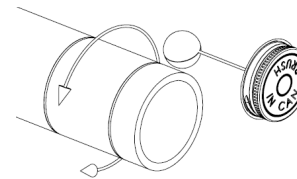
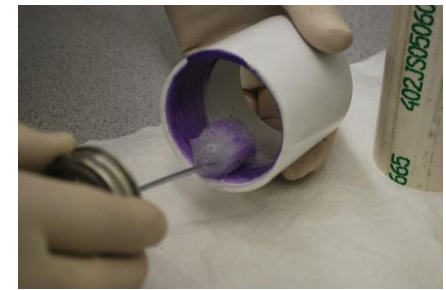

Pipe

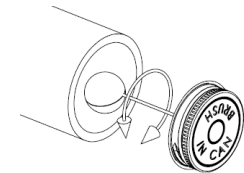

Fitting

Suggested Tools

- Oatey Solvent Cement – see **ASTM D 2564 (PVC)**

Step Seven – Joining Pipe and Fitting

- While the cement is still wet, immediately assemble the pipe and fitting, rotating the pipe 1/4 to 1/2 turn (if possible) until the fitting stop is reached
 - Use the second mark made on the pipe OD to ensure the pipe is fully bottomed into the fitting
- Hold the assembly together for approximately 30 seconds to avoid push out
 - A continuous bead of cement should be evident around the pipe and fitting juncture
 - ◆ If the bead is not continuous, sufficient cement may not have been applied and the joint may be defective
 - In this case, the fitting may need to be discarded and the joint reassembled
- Wipe excess cement from the pipe and fitting surfaces for an attractive, professional appearance and to expedite cure times

Proper Technique

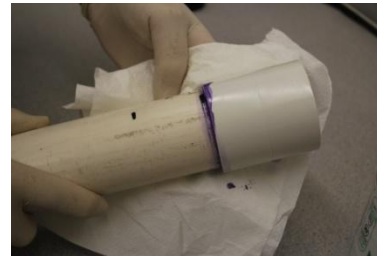
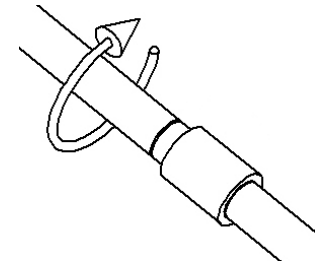

Suggested Tools

- Clean, Dry Cloth or Towel

Step Eight – Cure and Set Up Times

- Systems must be sufficiently cured before testing
- Cure time is defined as the time required before pressure testing a system
 - Cure times are dependent on:
 - ◆ System diameter
 - ◆ Temperature
 - ◆ Humidity
 - ◆ Test pressure
 - ◆ Fluid temperature
 - In damp or humid conditions, allow additional cure time (50%)
- Do not handle solvent-welded joints until they have been allowed sufficient time to set up

Cure Times



Joint Cure Times for PVC/CPVC Solvent Cements

Joint Cure Time is the time required before pressure testing the system.

In damp or humid weather, allow 50% additional cure time

Relative Humidity 60% or less	Pipe Diameter 1/2" to 1-1/4"		Pipe Diameter 1 1/2" to 3"		Pipe Diameter 4" to 5"		Pipe Diameter 6" to 8"		Pipe Diameter 10" to 16"		Pipe Diameter 18*
	Up to 180 psi	180 psi +	Up to 180 psi	180 psi +	Up to 180 psi	180 psi +	Up to 180 psi	180 psi +	Up to 100 psi	Up to 100 psi	
60° -100°F	1 Hour	6 Hours	2 Hours	12 Hours	6 Hours	18 Hours	8 Hours	24 Hours	24 Hours	36 Hours	
40° - 60°F	2 Hours	12 Hours	4 Hours	24 Hours	12 Hours	36 Hours	16 Hours	48 Hours	48 Hours	72 Hours	
20° - 40°F	6 Hours	36 Hours	12 Hours	72 Hours	36 Hours	4 Days	3 Days	9 Days	8 Days	12 Days	
0° - 20°F	8 Hours	48 Hours	16 Hours	96 Hours	48 Hours	8 Days	4 Days	12 Days	10 Days	14 Days	

This chart can be used as a guideline to determine joint cure time.
 These figures should only be used as a general guide. Conditions in the field may vary.

Step Nine – Testing

- Oatey recommends water testing all plumbing systems in accordance with local codes
 - In the United States, typical codes require systems to be filled (water) and monitored for a period of time prior to system approval
- **Water Test** - The system is plugged at all openings except one and water is introduced into the system
 - Based on the building, the water is measured in a stack test or a pressurized PSIG test
 - ◆ If the test fails, water can be seen leaking out of pipe joints
 - ◆ Leaking joints must be cut-out and replaced. Do not reuse fittings
 - ◆ **This product is not for use in a system using or being tested by compressed air or gases**

Proper Technique

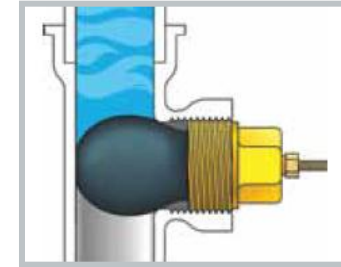
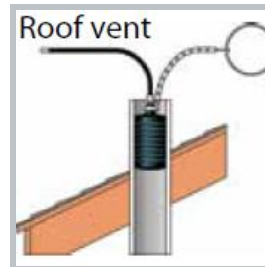
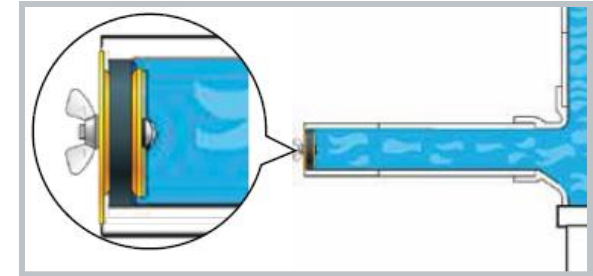
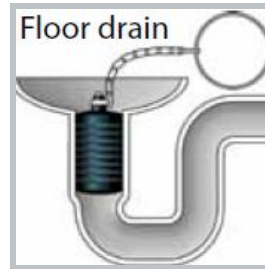

Suggested Tools

- Cherne pneumatic test plugs
- Cherne mechanical test plugs

Special Considerations / Common Errors



- Primer and solvent cements are designed to soften the surface of thermoplastics
 - Excess primer or cement in small diameter systems will weaken the pipe/fitting wall, and can lead to failures
 - ◆ Do not allow solvent cement to puddle inside the system
- For larger diameter systems, specialized equipment is recommended, such as a power beveller, roller applicators and pipe pullers (Oatey can provide additional information upon request)
 - De-burring and beveling are critical for all systems
- Solvent cement will dry out more rapidly at high temperatures and with low humidity
 - Shade the work area, work rapidly and use a higher viscosity solvent cement
- For cold or damp environments, keep the joints dry and extend cure times, making sure to work the cement well into the joint. Appropriately priming pipe and fitting become even more critical in colder temperatures.
- Solvent cement acts as a lubricant, and can allow pipe to “back out” of the fitting and eliminate the benefit of the interference fit between the pipe and fitting
 - Pipe must be held in place for 30 seconds to reduce this risk
- With a poorly cut pipe, the zone of interference is reduced and the joint loses strength
 - Always use proper pipe cutting techniques

Representative Images

Poor Pipe Cut

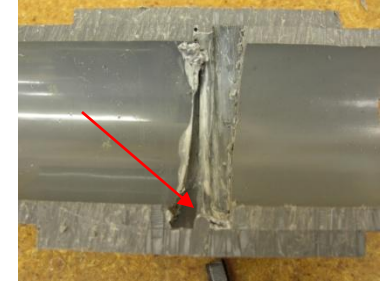

Insufficient Cement



Failure to Bottom Joint

