



STENNER

Metering Pumps
Manufactured Since 1957

Classic Series

INSTALLATION MANUAL

Table of Contents

Warranty and Service Policy	3
Safety Information	4-5
Pump Identification	6-7
Outputs	8-15
Materials of Construction	16
Accessory Checklist	17
Installation	18-26
Troubleshooting	27-30
Tube Replacement	31-35
Motor – exploded view and parts	36-38
Feed Rate Control – exploded view and parts	39-40
Pump Head – exploded view and parts	41-44
Pump Tubes	45
Check Valves	46

Warranty and Service Policy

Damaged or Lost Shipments

UPS and prepaid truck shipments: Check your order immediately upon arrival. All damage must be noted on the delivery receipt. Call Stenner Customer Service at 800-683-2378 for all shortages and damages within seven (7) days of receipt.

Returns

Stenner offers a 30-day return policy on factory direct purchases. Except as otherwise provided, no material will be accepted for return after 30 days from purchase. To return merchandise at any time, call Stenner at 800-683-2378 for a Returned Goods Authorization (RGA) number. A 15% re-stocking fee will be applied. Include a copy of your invoice or packing slip with your return.

Limited Warranty

G. H. Stenner & Co., Inc. will for a period of one (1) year from the date of purchase (proof of purchase required) repair or replace – at our option – all defective parts. G. H. Stenner & Co., Inc. is not responsible for any removal or installation costs. Pump tube assemblies

and rubber components are considered perishable and are not covered in this warranty. Pump tube will be replaced each time a pump is in for service, unless otherwise specified. The cost of the pump tube replacement will be the responsibility of the customer. G. H. Stenner & Co., Inc. will incur shipping costs for warranty products shipped from our factory in Jacksonville, Florida. Any tampering with major components, chemical damage, faulty wiring, weather conditions, water damage, power surges, or products not used with reasonable care and maintained in accordance with the instructions will void the warranty. G. H. Stenner & Co., Inc. limits its liability solely to the cost of the original product. We make no other warranty expressed or implied.

Disclaimer

The information contained in this manual is not intended for specific application purposes. G. H. Stenner & Co., Inc. reserves the right to make changes to prices, products, and specifications at any time without prior notice.

Safety Information

 **WARNING** Warns about hazards that **CAN** cause death, serious personal injury, or property damage if ignored.

 **ELECTRIC SHOCK HAZARD**

 **WARNING** **ELECTRIC SHOCK HAZARD:** Pump supplied with grounding power cord and attached plug. To reduce risk of electrical shock, connect only to a properly grounded, grounding type receptacle.

 **AVERTISSEMENT** **RISQUE DE CHOC ELECTRIQUE:** Cette pompe est équipée d'une fiche de mise à terre. Pour réduire le risque de choc électrique, s'assurer que la fiche est bien raccordée à une prise de courant avec une connexion de mise à terre.

 **DO NOT** alter the power cord or plug end.

 **DO NOT** use receptacle adapters.

 **DO NOT** use pump with a damaged or altered power cord or plug. Contact the factory or an authorized service facility for repair.

 **WARNING** **HAZARDOUS VOLTAGE:** **DISCONNECT** power cord before removing motor cover for service. **Electrical service by trained personnel only.**

 **WARNING** **EXPLOSION HAZARD:** This pump is not explosion proof. **Do Not** install or operate in an explosive environment.

 **WARNING** **RISK OF CHEMICAL EXPOSURE:** Potential for chemical burns, fire, explosion, personal injury, or property damage. To reduce risk of exposure, the use of proper personal protective equipment is mandatory.

 **WARNING** **RISK OF FIRE HAZARD:** **Do Not** install or operate on any flammable surface.

 **WARNING** **RISK OF CHEMICAL OVERDOSE:** To reduce risk, follow proper installation methods and recommendations. Check your local codes for additional guidelines.



THIS PRODUCT HAS BEEN
TESTED AND CERTIFIED BY
THE WATER QUALITY ASSOCIATION
ACCORDING TO NSF/ANSI 61 FOR
MATERIALS SAFETY ONLY.

Safety Information continued

⚠ CAUTION Warns about hazards that **WILL** or **CAN** cause minor personal injury or property damage if ignored.

⚠ CAUTION PLUMBING:

Chemical feed pump installation must always adhere to your local plumbing codes and requirements. Be sure installation does not constitute a cross connection. Check local plumbing codes for guidelines.

❗ NOTICE: Indicates special instructions or general mandatory action.

❗ NOTICE: This metering pump is portable and designed to be removable from the plumbing system without damage to the connections.

❗ NOTICE: This metering pump and its components have been tested for use with the following chemicals: Sodium Hypochlorite (10-15%), Muriatic Acid (20-22 Baume, 31.5% Hcl), and Soda Ash.

❗ NOTE: Cette a pompe de dosage et ses composants ont été testés pour utilisation avec les produits chimiques suivants; Hypochlorite de Sodium (solution de 10-15%); Acide Muriatique (20-22 Baume, 31.5% Hcl); Cendre de Soude.

⚠ This is the safety alert symbol. When displayed in this manual or on the equipment, look for one of the following signal words alerting you to the potential for personal injury or property damage.

⚠ PUMP SUITABLE FOR USE OUTDOORS when installed with a Stenner Rain Roof Part No. MP90000.

⚠ Electrical installation should adhere to all national and local codes. Consult a licensed professional for assistance with proper electrical installation.

⚠ Removing power from pool/spa recirculation pump must also remove power from pump.

⚠ The use of an auxiliary safety device (not supplied), such as a flow switch or sensor, is recommended to prevent feed pump operation in the event of a recirculation pump failure or if flow is not sensed.

⚠ Point of chemical injection should be beyond all pumps, filters, and heaters.

⚠ PUMP INTENDED FOR INDOOR USE.

⚠ Cette pompe est prévue pour utilisation à l'intérieur.

Pump Identification

Identify your pump using the label on the box or the pump.

Box Label

 STENNER Reliable Chemical Feed Pumps Since 1957	
MODEL/MODELO	85MHP5
SERIAL NO./NO. DE SERIAL	02010503943
VOLTAGE/VOLTAJE	120
MAX GPD/MAX LPD	5/18.9 Adjustable Ajustable
PSI/BAR	100/6.9
SUCTION/DISCHARGE TUBING TUBO DE SUCCION/DESCARGA	1/4" White 1/4" Blanco
ITEM NO./NO. DE PARTE	85MJH1A1STAA
3174 DeSalvo Road • Jacksonville, FL 32246	



Model



Serial Number



Voltage



Maximum Output per Day



Maximum Operating Pressure



Suction/Discharge Tubing



Item Number for
Placing Order

Pump Identification continued

Pump Label



G.H. STENNER & CO., INC.
Jacksonville, FL
Phone: (904)641-1666
MADE IN U.S.A.

METERING PUMP



UL LISTED
96FO

Thermally Protected Motor for Indoor Use
Motor Termal Protegido para el Uso Interior

⚠️ [WARNING] TO REDUCE RISK OF ELECTRIC SHOCK, CONNECT ONLY TO A PROPERLY GROUNDED GROUNDING-TYPE RECEPTACLE.

⚠️ [ATENCION] PARA REDUCIR EL RIESGO DE DESCARGA ELECTRICA, CONECTELO A UN RECEPTACULO ELECTRICO CON CONEXION A TIERRA ADECUADO.

See installation instructions for overdosing protection.
Lea las instrucciones de instalación para evitar sobredosis de químicos.

METERING PUMP
LR79585



SA NRTL / C



THIS PRODUCT HAS BEEN TESTED AND CERTIFIED BY THE WATER QUALITY ASSOCIATION ACCORDING TO NSF/ANSI 61 FOR MATERIALS SAFETY ONLY.

See installation instructions for overdosing protection.
Lea las instrucciones de instalación para evitar sobredosis de químicos.

SA NRTL / C



ETL SANITATION LISTED
94247

Model →

85MHP5	85MJH1A1STAA
<small>MODEL # NO. DE MODELO</small>	<small>ITEM # NO. DE PARTE</small>

Agency Listings
(varies by model)

Maximum Pressure →

100 psi / 6.9 bar	120VAC / 60Hz
--------------------------	----------------------

Item Number for Placing Order

Amp Draw →

1.7 amp	5 GPD / 18.9 LPD
----------------	-------------------------

Voltage

Maximum Output per Day

Serial Number

02010503943
<small>SERIAL # NO. DE SERIAL</small>

Serial Number

US and Canada call 1-800-683-2378, other countries call 1-904-641-1666

Outputs 45 series

The dial ring for adjustable pumps is marked L-10; L=5%, 1-10 indicates 10% increments of maximum output. (20:1 Turndown Ratio)

Approx. Outputs @ 60 Hz

Approx. Outputs @ 50 Hz

Single Head Model	Maximum Pressure	Pump Tube Number	gallons per day	liters per day	gallons per hour	liters per hour	ounces per minute	milliliters per minute	liters per day	liters per hour	milliliters per minute
Adjustable 45MHP2* 45M1	100 psi / 6.9 bar 25 psi / 1.7 bar	#1	0.2 to 3.0	0.8 to 11.4	0.01 to 0.13	0.03 to 0.48	0.02 to 0.27	0.56 to 7.92	0.6 to 9.1	0.03 to 0.38	0.42 to 6.32
Fixed Output 45MHP2* 45MP1	100 psi / 6.9 bar 25 psi / 1.7 bar		3.0	11.4	0.13	0.48	0.27	7.92	9.1	0.38	6.32
Adjustable 45MHP10* 45M2	100 psi / 6.9 bar 25 psi / 1.7 bar	#2	0.5 to 10.0	1.9 to 37.9	0.02 to 0.42	0.08 to 1.58	0.04 to 0.89	1.32 to 26.32	1.5 to 30.3	0.06 to 1.26	1.04 to 21.04
Fixed Output 45MHP10* 45MP2	100 psi / 6.9 bar 25 psi / 1.7 bar		10.0	37.9	0.42	1.58	0.89	26.32	30.3	1.26	21.04
Adjustable 45MHP22* 45M3	100 psi / 6.9 bar 25 psi / 1.7 bar	#7 #3	1.1 to 22.0	4.2 to 83.3	0.05 to 0.92	0.18 to 3.47	0.10 to 1.96	2.92 to 57.85	3.3 to 66.6	0.14 to 2.78	2.29 to 46.25
Fixed Output 45MHP22* 45MP3	100 psi / 6.9 bar 25 psi / 1.7 bar	#7 #3	22.0	83.3	0.92	3.47	1.96	57.85	66.6	2.78	46.25
Adjustable 45M4	25 psi / 1.7 bar	#4	1.7 to 35.0	6.4 to 132.5	0.07 to 1.46	0.27 to 5.52	0.15 to 3.11	4.44 to 92.01	5.1 to 106.0	0.21 to 4.42	3.54 to 73.61
Fixed Output 45MP4	25 psi / 1.7 bar		35.0	132.5	1.46	5.52	3.11	92.01	106.0	4.42	73.61
Adjustable 45M5	25 psi / 1.7 bar	#5	2.5 to 50.0	9.5 to 189.3	0.10 to 2.08	0.40 to 7.89	0.22 to 4.44	6.60 to 131.46	7.6 to 151.4	0.32 to 6.31	5.28 to 105.14
Fixed Output 45MP5	25 psi / 1.7 bar		50.0	189.3	2.08	7.89	4.44	131.43	151.4	6.31	105.14

*pump supplied with injection check valve for 26-100 psi applications



NOTICE: The information within this chart is solely intended for use as a guide. The output data is an approximation based on pumping water under a controlled testing environment. Many variables can affect the output of the pump. G. H. Stenner & Co., Inc. recommends that all metering pumps undergo field calibration by means of analytical testing to confirm their outputs.

Outputs 85 series

The dial ring for adjustable pumps is marked L-10; L=5%, 1-10 indicates 10% increments of maximum output. (20:1 Turndown Ratio)

Single Head Model	Maximum Pressure	Pump Tube Number	Approx. Outputs @ 60 Hz						Approx. Outputs @ 50 Hz		
			gallons per day	liters per day	gallons per hour	liters per hour	ounces per minute	milliliters per minute	liters per day	liters per hour	milliliters per minute
Adjustable 85MHP5* 85M1	100 psi / 6.9 bar 25 psi / 1.7 bar	#1	0.3 to 5.0	1.1 to 18.9	0.01 to 0.21	0.05 to 0.79	0.03 to 0.44	0.76 to 13.13	0.9 to 15.1	0.4 to 0.63	0.63 to 10.49
Fixed Output 85MPHP5* 85MP1	100 psi / 6.9 bar 25 psi / 1.7 bar		5.0	18.9	0.21	0.79	0.44	13.13	15.1	0.63	10.49
Adjustable 85MHP17 85M2	100 psi / 6.9 bar 25 psi / 1.7 bar	#2	0.8 to 17.0	3.0 to 64.4	0.03 to 0.71	0.13 to 2.68	0.07 to 1.51	2.08 to 44.65	2.4 to 51.5	0.10 to 2.15	1.67 to 35.76
Fixed Output 85MPHP17* 85MP2	100 psi / 6.9 bar 25 psi / 1.7 bar		17.0	64.4	0.71	2.68	1.51	44.65	51.5	2.15	35.76
Adjustable 85MHP40 85M3	100 psi / 6.9 bar 25 psi / 1.7 bar	#7 #3	2.0 to 40.0	7.6 to 151.4	0.08 to 1.67	0.32 to 6.31	0.18 to 3.55	5.27 to 105.14	6.1 to 121.1	0.25 to 5.05	4.24 to 84.10
Fixed Output 85MPHP40* 85MP3	100 psi / 6.9 bar 25 psi / 1.7 bar	#7 #3	40	151.4	1.67	6.31	3.55	105.14	121.1	5.05	84.10
Adjustable 85M4	25 psi / 1.7 bar	#4	3.0 to 60.0	11.4 to 227.1	0.13 to 2.5	0.48 to 9.46	0.27 to 5.33	7.92 to 157.71	9.1 to 181.7	0.38 to 7.57	6.32 to 126.18
Fixed Output 85MP4	25 psi / 1.7 bar		60.0	227.1	2.50	9.46	5.33	157.71	181.7	7.57	126.18
Adjustable 85M5	25 psi / 1.7 bar	#5	4.3 to 85.0	16.3 to 321.8	0.18 to 3.54	0.68 to 13.40	0.38 to 7.55	11.32 to 223.40	13.0 to 257.4	0.54 to 10.73	9.03 to 178.75
Fixed Output 85MP5	25 psi / 1.7 bar		85.0	321.8	3.54	13.40	7.55	223.40	257.4	10.73	178.75

*pump supplied with injection check valve for 26-100 psi applications



NOTICE: The information within this chart is solely intended for use as a guide. The output data is an approximation based on pumping water under a controlled testing environment. Many variables can affect the output of the pump. G. H. Stenner & Co., Inc. recommends that all metering pumps undergo field calibration by means of analytical testing to confirm their outputs.

US and Canada call 1-800-683-2378, other countries call 1-904-641-1666

Outputs 100 series

The dial ring for adjustable pumps is marked L-10; L=5%, 1-10 indicates 10% increments of maximum output. (20:1 Turndown Ratio)

Approx. Outputs @ 60 Hz

Approx. Outputs @ 50 Hz

Double Head Model	Maximum Pressure	Pump Tube Number	Approx. Outputs @ 60 Hz						Approx. Outputs @ 50 Hz		
			gallons per day	liters per day	gallons per hour	liters per hour	ounces per minute	milliliters per minute	liters per day	liters per hour	milliliters per minute
Adjustable 100DMHP5* 100DM1	100 psi / 6.9 bar 25 psi / 1.7 bar	#1	0.3 to 6.0	1.1 to 22.7	0.01 to 0.25	0.05 to 0.95	0.03 to 0.53	0.76 to 15.76	0.9 to 18.2	0.04 to 0.76	0.61 to 12.64
Fixed Output 100DMPHP5* 100DMP1	100 psi / 6.9 bar 25 psi / 1.7 bar		6.0	22.7	0.25	0.95	0.53	15.76	18.2	0.76	12.64
Adjustable 100DMHP20* 100DM2	100 psi / 6.9 bar 25 psi / 1.7 bar	#2	1.0 to 20.0	3.8 to 75.7	0.04 to 0.83	0.16 to 3.15	0.09 to 1.78	2.64 to 52.57	3.0 to 60.6	0.13 to 2.53	2.11 to 42.06
Fixed Output 100DMPHP20* 100DMP2	100 psi / 6.9 bar 25 psi / 1.7 bar		20.0	75.7	0.83	3.15	1.78	52.57	60.6	2.53	42.06
Adjustable 100DM3	25 psi / 1.7 bar	#3	2.2 to 44.0	8.3 to 166.5	0.09 to 1.83	0.35 to 6.94	0.19 to 3.91	5.76 to 115.63	6.6 to 133.2	0.28 to 5.55	4.58 to 92.50
Fixed Output 100DMP3	25 psi / 1.7 bar		44.0	166.5	1.83	6.94	3.91	115.63	133.2	5.55	92.50
Adjustable 100DM4	25 psi / 1.7 bar	#4	3.5 to 70.0	13.2 to 265.0	0.15 to 2.92	0.55 to 11.04	0.31 to 6.22	9.17 to 184.03	10.6 to 212.0	0.44 to 8.83	7.36 to 147.22
Fixed Output 100DMP4	25 psi / 1.7 bar		70.0	265.0	2.92	11.04	6.22	184.03	212.0	8.83	147.22
Adjustable 100DM5	25 psi / 1.7 bar	#5	5.0 to 100.0	18.9 to 378.5	0.21 to 4.17	0.79 to 15.77	0.44 to 8.88	13.13 to 262.88	15.1 to 302.8	0.63 to 12.61	10.49 to 210.28
Fixed Output 100DMP5	25 psi / 1.7 bar		100.0	378.5	4.17	15.77	8.88	262.88	302.8	12.61	210.28

*pump supplied with injection check valve for 26-100 psi applications



NOTICE: The information within this chart is solely intended for use as a guide. The output data is an approximation based on pumping water under a controlled testing environment. Many variables can affect the output of the pump. G. H. Stenner & Co., Inc. recommends that all metering pumps undergo field calibration by means of analytical testing to confirm their outputs.

Outputs 170 series

The dial ring for adjustable pumps is marked L-10; L=5%, 1-10 indicates 10% increments of maximum output. (20:1 Turndown Ratio)

Double Head Model	Maximum Pressure	Pump Tube Number	Approx. Outputs @ 60 Hz						Approx. Outputs @ 50 Hz		
			gallons per day	liters per day	gallons per hour	liters per hour	ounces per minute	milliliters per minute	liters per day	liters per hour	milliliters per minute
Adjustable 170DMHP9* 170DM1	100 psi / 6.9 bar 25 psi / 1.7 bar	#1	0.5 to 10.0	1.9 to 37.9	0.02 to 0.42	0.08 to 1.58	0.04 to 0.89	1.32 to 26.32	1.5 to 30.3	0.06 to 1.26	1.04 to 21.04
Fixed Output 170DMPHP9* 170DMP1	100 psi / 6.9 bar 25 psi / 1.7 bar		10.0	37.9	0.42	1.58	0.89	26.32	30.3	1.26	21.04
Adjustable 170DMHP34* 170DM2	100 psi / 6.9 bar 25 psi / 1.7 bar	#2	1.7 to 34.0	6.4 to 128.7	0.07 to 1.42	0.27 to 5.36	0.15 to 3.02	4.44 to 89.38	5.1 to 103.0	0.21 to 4.29	3.54 to 71.55
Fixed Output 170DMPHP34* 170DMP2	100 psi / 6.9 bar 25 psi / 1.7 bar		34.0	128.7	1.42	5.36	3.02	89.38	103.0	4.29	71.55
Adjustable 170DM3	25 psi / 1.7 bar	#3	4.0 to 80.0	15.1 to 302.8	0.17 to 3.33	0.63 to 12.62	0.35 to 7.11	10.49 to 210.28	12.1 to 242.2	0.50 to 10.09	8.40 to 168.22
Fixed Output 170DMP3	25 psi / 1.7 bar		80.0	302.8	3.33	12.62	7.11	210.28	242.2	10.09	168.22
Adjustable 170DM4	25 psi / 1.7 bar	#4	6.0 to 120.0	22.7 to 454.2	0.25 to 5.00	0.95 to 18.93	0.53 to 10.66	15.76 to 315.42	18.2 to 363.4	0.76 to 15.14	12.64 to 252.36
Fixed Output 170DMP4	25 psi / 1.7 bar		120.0	454.2	5.00	18.93	10.66	315.42	363.4	15.14	252.36
Adjustable 170DM5	25 psi / 1.7 bar	#5	8.5 to 170.0	32.2 to 643.5	0.35 to 7.08	1.34 to 26.8	0.76 to 15.10	22.36 to 446.88	25.7 to 514.8	1.07 to 21.45	17.92 to 357.50
Fixed Output 170DMP5	25 psi / 1.7 bar		170.0	643.6	7.08	26.8	15.10	446.88	514.8	21.45	357.50

*pump supplied with injection check valve for 26-100 psi applications



NOTICE: The information within this chart is solely intended for use as a guide. The output data is an approximation based on pumping water under a controlled testing environment. Many variables can affect the output of the pump. G. H. Stenner & Co., Inc. recommends that all metering pumps undergo field calibration by means of analytical testing to confirm their outputs.

Outputs 100 MDC series

Determining Output for Dual Head Dual Control Models

- The dial ring for adjustable pumps is marked L-10; L=5%, 1-10 indicates 10% increments of maximum output.
- The turndown ratio is 20:1.
- On the MDC models, the outer pump head operates on a percentage of the inner head (closest to the motor).
- Setting #10 on both pump heads will deliver the pump's maximum output and is the only time each pump head will output the same amount.

Example Using 100MDC5

- Decide on the desired output for the inner head.
- Note the setting on the dial ring that represents the desired output.
For example setting #4 = 40% of max output
In the 100MDC5 model, setting #4 = 20 GPD
- Repeat the above steps to calculate the output of the outer head.
Using setting #3 in this example,
#3 = 30% of the inside head output
 $20 \text{ GPD} \times 30\% = 6 \text{ GPD}$

In this example using pump model 100MDC5, the output for the inside head would be 20 GPD and 6 GPD for the outside head.

Outputs 100 MDC series

The dial ring for adjustable pumps is marked L-10; L=5%, 1-10 indicates 10% increments of maximum output. (20:1 Turndown Ratio)

Outputs for Inner Pump Head Only

Dual Head Dual Control Model	Maximum Pressure	Pump Tube Number	Approx. Outputs @ 60 Hz						Approx. Outputs @ 50 Hz		
			gallons per day	liters per day	gallons per hour	liters per hour	ounces per minute	milliliters per minute	liters per day	liters per hour	milliliters per minute
Adjustable 100MDCHP5* 100MDC1	100 psi / 6.9 bar 25 psi / 1.7 bar	#1	0.2 to 3.0	0.8 to 11.4	0.01 to 0.13	0.03 to 0.48	0.02 to 0.27	0.56 to 7.92	0.6 to 9.1	0.03 to 0.38	0.42 to 6.32
100MDCHP20* 100MDC2	100 psi / 6.9 bar 25 psi / 1.7 bar	#2	0.5 to 10.0	1.9 to 37.9	0.02 to 0.42	0.08 to 1.58	0.04 to 0.89	1.32 to 26.32	1.5 to 30.3	0.06 to 1.26	1.04 to 21.04
100MDC3	25 psi / 1.7 bar	#3	1.1 to 22.0	4.2 to 83.3	0.05 to 0.92	0.18 to 3.47	0.10 to 1.96	2.92 to 57.85	3.3 to 66.6	0.14 to 2.78	2.29 to 46.25
100MDC4	25 psi / 1.7 bar	#4	1.7 to 35.0	6.4 to 132.5	0.07 to 1.46	0.27 to 5.52	0.15 to 3.11	4.44 to 92.01	5.1 to 106.0	0.21 to 4.42	3.54 to 73.61
100MDC5	25 psi / 1.7 bar	#5	2.5 to 50.0	9.5 to 189.3	0.10 to 2.08	0.40 to 7.89	0.22 to 4.44	6.60 to 131.46	7.6 to 151.4	0.32 to 6.31	5.28 to 105.14

*pump supplied with injection check valve for 26-100 psi applications



NOTICE: The information within this chart is solely intended for use as a guide. The output data is an approximation based on pumping water under a controlled testing environment. Many variables can affect the output of the pump. G. H. Stenner & Co., Inc. recommends that all metering pumps undergo field calibration by means of analytical testing to confirm their outputs.

Outputs 170 MDC series

Determining Output for Dual Head Dual Control Models

- The dial ring for adjustable pumps is marked L-10; L=5%, 1-10 indicates 10% increments of maximum output.
- The turndown ratio is 20:1.
- On the MDC models, the outer pump head operates on a percentage of the inner head (closest to the motor).
- Setting #10 on both pump heads will deliver the pump's maximum output and is the only time each pump head will output the same amount.

Example Using 170MDCHP34

- Decide on the desired output for the inner head.
- Note the setting on the dial ring that represents the desired output.
For example setting #8 = 80% of max output
In the 170MDCHP34 model, setting #8 = 13.6 GPD
- Repeat the above steps to calculate the output of the outer head.
Using setting #6 in this example,
#6 = 60% of the inner head output
 $13.6 \text{ GPD} \times 60\% = 8.5 \text{ GPD}$

In this example using pump model 170MDCHP34, the output for the inner head would be 13.6 GPD and 8.5 GPD for the outer head.

Outputs 170 MDC series

The dial ring for adjustable pumps is marked L-10; L=5%, 1-10 indicates 10% increments of maximum output. (20:1 Turndown Ratio)

Outputs for Inner Pump Head Only

Dual Head Dual Control Model	Maximum Pressure	Pump Tube Number	Approx. Outputs @ 60 Hz						Approx. Outputs @ 50 Hz		
			gallons per day	liters per day	gallons per hour	liters per hour	ounces per minute	milliliters per minute	liters per day	liters per hour	milliliters per minute
Adjustable 170MDCP9* 170MDC1	100 psi / 6.9 bar 25 psi / 1.7 bar	#1	0.3 to 5.0	1.1 to 18.9	0.01 to 0.21	0.05 to 0.79	0.03 to 0.44	0.76 to 13.13	0.9 to 15.1	0.4 to 0.63	0.63 to 10.49
170MDCP34* 170MDC2	100 psi / 6.9 bar 25 psi / 1.7 bar	#2	0.8 to 17.0	3.0 to 64.4	0.03 to 0.71	0.13 to 2.68	0.07 to 1.51	2.08 to 44.65	2.4 to 51.5	0.10 to 2.15	1.67 to 35.76
170MDC3	25 psi / 1.7 bar	#3	2.0 to 40.0	7.6 to 151.4	0.08 to 1.67	0.32 to 6.31	0.18 to 3.55	5.27 to 105.14	6.1 to 121.1	0.25 to 5.05	4.24 to 84.10
170MDC4	25 psi / 1.7 bar	#4	3.0 to 60.0	11.4 to 227.1	0.13 to 2.5	0.48 to 9.46	0.27 to 5.33	7.92 to 157.71	9.1 to 181.7	0.38 to 7.57	6.32 to 126.18
170MDC5	25 psi / 1.7 bar	#5	4.3 to 85.0	16.3 to 321.8	0.18 to 3.54	0.68 to 13.40	0.38 to 7.55	11.32 to 223.40	13.0 to 257.4	0.54 to 10.73	9.03 to 178.75

*pump supplied with injection check valve for 26-100 psi applications



NOTICE: The information within this chart is solely intended for use as a guide. The output data is an approximation based on pumping water under a controlled testing environment. Many variables can affect the output of the pump. G. H. Stenner & Co., Inc. recommends that all metering pumps undergo field calibration by means of analytical testing to confirm their outputs.

Materials of Construction

All Housings*	Lexan® Polycarbonate Plastic
Peristaltic Tube**	Santoprene® FDA Approved
Check Valve Duckbill	
Peristaltic Tube†	Tygothane® FDA Approved
Check Valve Duckbill**	Pellathane®
Suction/Discharge Tubing	LDPE Polyethylene-NSF/FDA Approved
Ferrules(1/4" & 6mm)	
Tube Fittings	Type 1 Rigid PVC-NSF Listed
Connecting Nuts	
Check Valve Fittings	
Strainer (ceramic weight included)	
All Fasteners	Stainless Steel

*Lexan® is a registered trademark of General Electric.
Consult General Electric for chemical resistance of Lexan®.

*Tygothane® is a registered trademark of Saint-Gobain
Performance Plastics, Pittsburgh, PA.

**Santoprene® is a registered trademark of Advanced
Elastomer System, Akron, OH.

**Pellathane® is a registered trademark of The Dow
Company, Midland, MI.

Accessory Checklist – pre-installation

25 psi unit includes:





- (3) Connecting Nuts (1/4" or 3/8")
- (3) Ferrules w/1/4" & 6mm or
(2) Ferrules w/3/8"
- (1) Injection Fitting
- (1) Suction Line Strainer 1/4", 3/8" or 6mm
(ceramic weight included)
- (1) 20' Roll of Suction & Discharge Tubing
1/4" or 3/8" white or UV black
OR
6mm (Europe) white
- (1) Spare Pump Tube
- (1) Mounting Bracket
- (1) Installation Manual

100 psi unit includes:

- (3) Connecting Nuts (1/4" or 3/8")
- (3) Ferrules w/1/4" & 6mm or
(2) Ferrules w/3/8"
- (1) Injection Check Valve
- (1) Suction Line Strainer 1/4", 3/8" or 6mm
(ceramic weight included)
- (1) 20' Roll of Suction & Discharge Tubing
1/4" or 3/8" white or UV black
OR
6mm (Europe) white
- (1) Spare Pump Tube
- (1) Mounting Bracket
- (1) Installation Manual

Installation – additional safety instructions

 **NOTICE:** Indicates special instructions or general mandatory action.

-  Read all safety hazards before installing or servicing the pump. The pump is designed for installation and service by properly trained personnel.
-  Use all required personal protective equipment when working on or near a chemical metering pump.
-  Install the pump so that it is in compliance with all national and local plumbing and electrical codes.
-  Use the proper product to treat potable water systems, use only chemicals listed or approved for use.
-  Install the pump to work in conjunction with pool, spa, well pump, or system controls.

Installation continued – mount pump

Mount Pump

- ❗ **Select a dry location (to avoid water intrusion and pump damage) above the solution tank. Best recommended location is above the solution tank in a vertical position with the pump head pointed downward and the spill recovery (see next page) in place to reduce the risk and severity of damage.**
- ❗ **To prevent pump damage in the event of a pump tube leak, never mount the pump vertically with the pump head up.**
- ❗ **To avoid chemical damage from fumes, do not mount pump directly over an open solution tank. Keep tank covered.**
- ❗ **Avoid flooded suction or pump mounted lower than the solution container. Draw solution from the top of the tank. If pump is installed with a flooded suction, a shut-off valve or other device must be provided to stop flow to pump during service.**

- Use the mounting bracket as a template to drill pilot holes in mounting location.
- Secure bracket with fasteners or wall anchors. Slide pump into bracket.
- ❗ **Provide 8" clearance to allow pump orientation to be reversed during tube replacement. Do not allow water intrusion into the motor or corrosion and damage will occur.**
- ❗ **To prevent motor damage, verify with a volt meter that the receptacle voltage corresponds with the pump voltage.**
- Plug cord into receptacle and turn the motor power switch on. If the pump is adjustable, turn the dial ring to 10.
- Activate the pump by the pump control (flow switch, pressure switch, etc.) and verify rotation of the roller assembly within the clear pump head. Turn pump switch off.

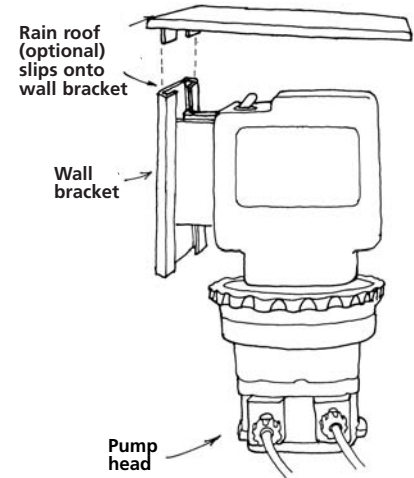

Installation continued – additional instructions for CE pumps

Additional Installation Instructions

1. All Class II Pumps located in Zone 1 of swimming pool areas require locating where flooding cannot occur.
2. This pump is intended to be installed as “fixed” as opposed to portable.
3. The Rain Roof must be installed and “vertical orientation” mounting of entire unit observed.
4. After installation, the power supply plug must be accessible during use.
5. This unit must be scrapped if the supply cord is damaged.
6. Observe and comply with all National Wiring Standards.

Zustätzliche Installierungsanweisung un

1. Pumpen die sich in Zone 1 vom Schwimmbecken befinden sollen sind so einzurichten daß Überschwemmungen nicht vorkommen werden.
2. Diese Pumpe ist als fest montierte Ausrüstung bedacht und soll nicht umstellbar gebraucht werden.
3. Der Regendach muss installiert werden. Eine vertikale Asrichtung der Montage muß erzielt werden.
4. Die Stromversorgung muss nach der Installation noch zugänglich sein.
5. Bei beschädigter Verkabelung ist dieses Gerät nicht mehr zu gebrauchen.
6. Staatliche Vernetzungsvorchriften müssen eingehalten werden.

Instructions Supplémentaires d'Installation

1. Toutes les pompes installées dans la Zone 1 du périmètre de la piscine doivent être situées de manière à ne pas pouvoir être inondées.
2. Cette pompe est prévue pour installation fixe et non pas portable.
3. L'abri anti-pluie doit être installé et l'orientation verticale doit toujours être observée.
4. Après l'installation, la prise électrique doit rester accessible pendant l'utilisation.
5. Cette unité doit être mise au rebut si le cordon électrique est endommagé.
6. Observez et adhérez à toutes les Normes Nationales pour Installations Electriques.

Instucciones Adicionales Para instalación

1. Todas las bombas Clase II situadas en la Zona 1 de las áreas de la piscina requieren colocarse donde no puedan ser inundadas.
2. Esta bomba es para ser instalada “fija” en vez de portátil.
3. Es necesario instalar el techo de lluvia, y montar la unidad entera siguiendo una orientación vertical.
4. Después de la instalación el enchufe suministrador de energía debe estar accesible durante el uso.
5. Se deberá desechar la unidad si el cordón de abastecimiento se deteriora.
6. Observe y cumpla con todas las Reglas Nacionales para Instalaciones Eléctricas.

Istruzioni Supplementari Per L'installazione

1. Tutte le pompe Classe II localizzate nella Zona 1 della superficie circostante la piscina devono essere collocate dove gli allagamenti non possono accadere.
2. Questa pompa, é inteso, deve essere installata come ‘fissa’ e non come portatile.
3. La tettoia deve essere installata e il montaggio ‘orientazione verticale’ dell’intera unità deve essere osservato.
4. Dopo l’installazione, la spina deve essere accessibile durante l’uso.
5. Questa unità deve essere gettata via se il filo elettrico é danneggiato.
6. Osservare e aderire a tutte le Norme Nazionali Sugli Impianti Elettrici.

Installation Diagram

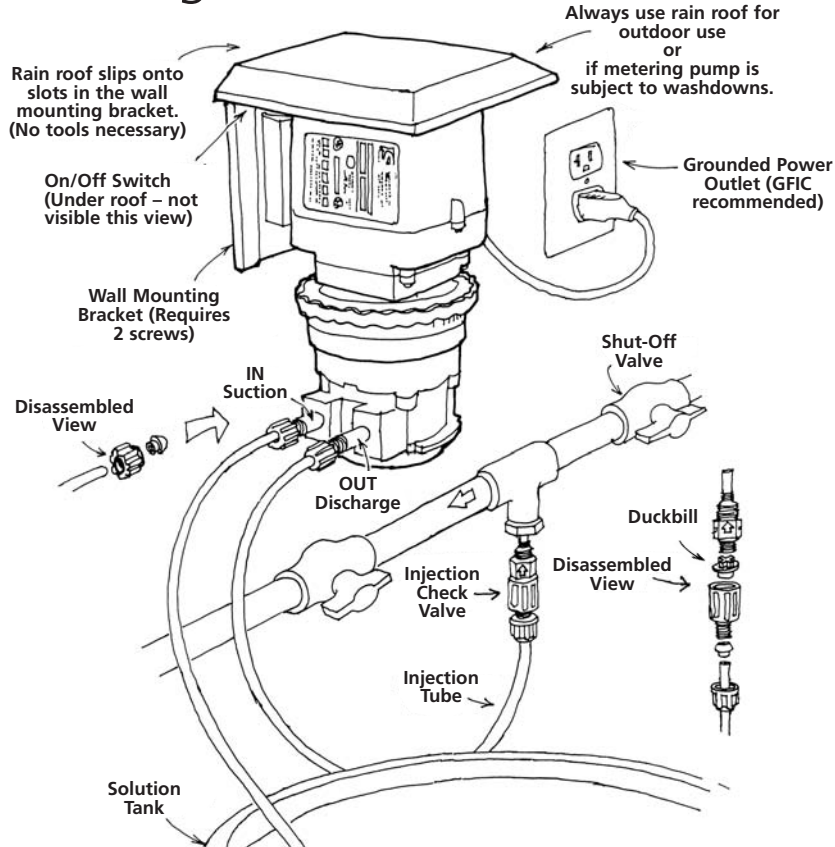

US and Canada call 1-800-683-2378, other countries call 1-904-641-1666

Installation continued – spill recovery

Spill Recovery

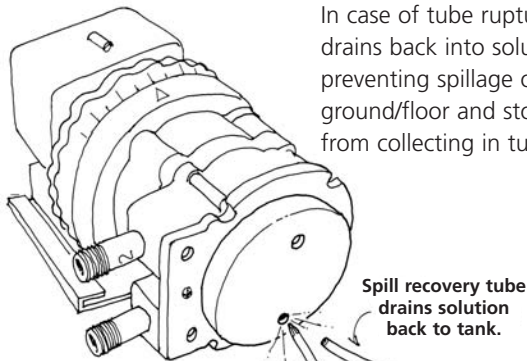

In case of tube rupture, chemical drains back into solution tank, preventing spillage onto ground/floor and stops chemical from collecting in tube housing.

Partial hole is punched through with a #2 Phillips head screwdriver.

1/4" plastic spill recovery tube is inserted in hole. Use section of suction/discharge tubing.

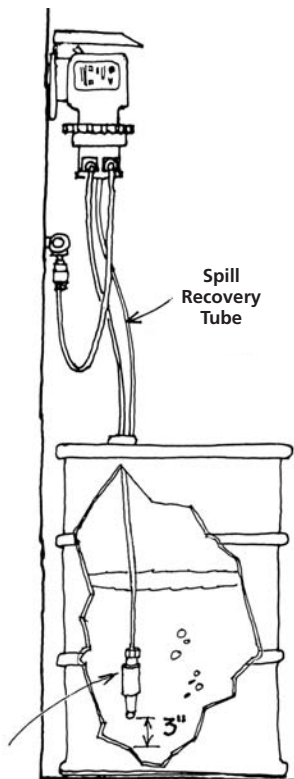
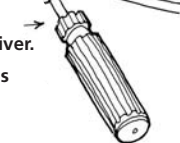

Spill Recovery Tube

Strainer w/weight

Installation continued – suction line

Install Suction Line

- Uncoil the suction line and cut a section to assure that the end will be 2-3" above the bottom of the solution tank. Use the outside of the solution tank as a guide to cut to proper length.

- ❗ **Allow sufficient slack to avoid kinks and stress cracks. Always make a clean square cut to assure that the suction line is burr free. Normal maintenance requires trimming.**
- ❗ **Suction lines that extend to the bottom of the tank can result in debris pickup leading to clogged injectors and possible tube failure.**

- Slide the suction line through the connecting nut and ferrule and fully insert the line into the bottom pump tube fitting as indicated by the "IN" on the tube housing cover.
- Finger tighten nut to the threaded tube fitting while holding the tube fitting.
- ❗ **Over tightening the ferrule and nut with a wrench may result in damaged fittings, crushed ferrules, and air pickup.**
- ❗ **Do not use thread sealant tape on pump tube connections or tools to tighten connections.**

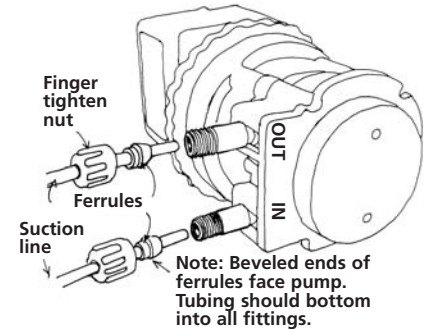
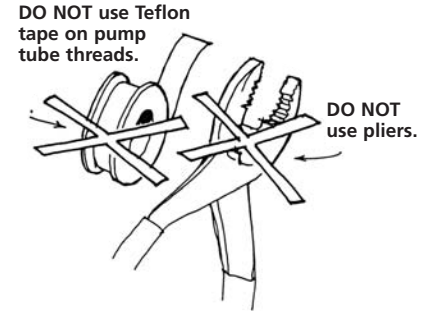

Installation continued – suction line

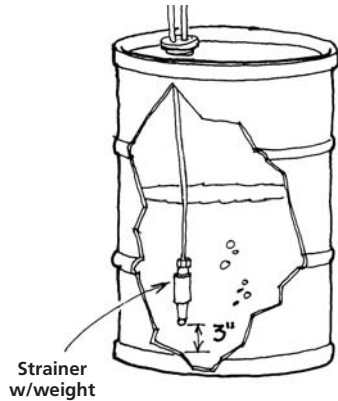

- Drill a 17/64" hole into the lid or bung cap of the solution tank. Secure strainer weight to the end of the suction line as per provided instructions and feed it into the hole.
- Suspend 2-3" above the tank bottom.

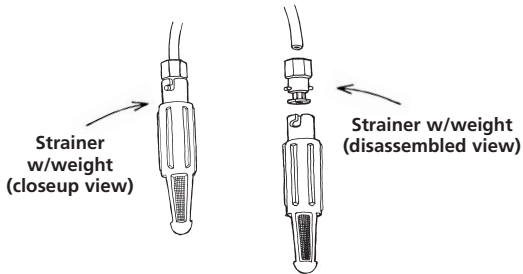

Installation continued – discharge line

Install Discharge Line

- Make a secure finger tight connection on the discharge fitting of the pump head as instructed in Install Suction Line instructions.

! Do not use thread sealant tape on pump tube connections or tools to tighten connections.

! **WARNING**

HAZARDOUS PRESSURE:

Shut off water or circulation system and bleed off any system pressure.

! Locate a point of injection beyond all pumps and filters or as determined by the application.

- A 1/4" or 1/2" female NPT connection is required for the injection fitting. If there is no FNPT fitting available, provide one by either tapping the pipe or installing FNPT pipe tee fitting.
- Wrap MNPT end of injection fitting with 2 to 3 turns of threading tape. If necessary trim straight-sided extension tip so it is in the flow of water.
See Illustration
- Tighten the injection fitting into the FNPT fitting.

DO NOT use Teflon tape on pump tube threads.

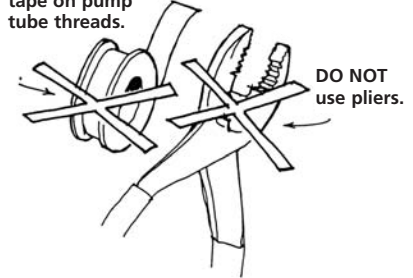

Trimming Check Valves

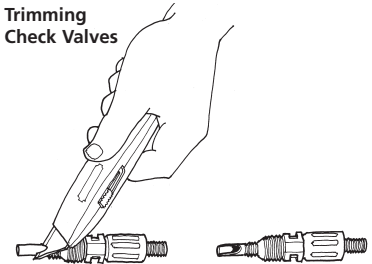

Installation continued – discharge line

Typical Point of Injection

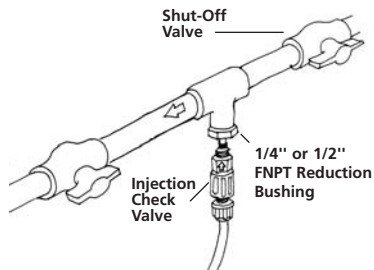

! The injection point and fitting require periodic maintenance to clean any deposits or buildup. To allow quick access to the point of injection, Stenner recommends the installation of shut-off valves.

26-100 psi models:

- Prior to making tubing connection, test check valve and NPT threads for leaks by pressurizing system.
- Tighten an additional 1/4 turn if necessary. Make final tube connection as instructed in Install Suction Line instructions.

0-25 psi models:

- Low-pressure models do not have a check valve and check valve body. Insert the tubing 3/4" to 1" into the injection fitting and make tubing connection as instructed in Install Suction Line instructions.
- Turn pump switch on and observe chemical flow as actuated by system.
- **!** Do not mix chemicals in the solution container. Follow recommended mixing procedures according to the manufacturer.
- **!** Do not operate pump unless chemical is completely in solution. Turn pump off when replenishing solution.
- After a suitable amount of dosing time, perform tests for required chemical levels. If necessary, fine-tune dosing levels by rotating dial ring (adjustable pumps only).



WARNING

HAZARDOUS PRESSURE:

Shut off water or circulation system and bleed off any system pressure.

Troubleshooting – motor

PROBLEM	POSSIBLE CAUSE		SOLUTION
Motor	 WARNING HAZARDOUS VOLTAGE: DISCONNECT power cord before removing motor cover for service. Electrical service should be by trained personnel only.		
Noise is excessively loud.	Ball bearings are worn. Lubrication is insufficient. Gears or gear posts are worn.		Replace rotor assembly. Grease gears and gear posts. Inspect/replace gears and gear posts.
Motor does not work; fan is not turning.	Electrical supply is faulty. Rotor bound to coil. Motor coil is damaged. Motor bearings are worn or damaged. Power cord is damaged. Rotor rusted to coil. Wire connections are faulty. Fan is obstructed.		Check supply voltage circuit. Check bearing brackets for cracks and replace if necessary. Replace motor coil. Replace rotor assembly. Inspect/replace power cord. Clean off coil and rotor or replace as needed. Inspect/repair electrical connections. Remove obstruction.
Motor runs; fan turns; output shaft does not.	Check all gears.		Replace gears as needed.
Motor overheats and shuts off and on.	Voltage is incorrect. Ambient temperature is high. Coil is damaged/malfunctioning.		Check that voltage and frequency match data label. Install pump in an area not to exceed a maximum of 125° F. Replace motor coil.
Phenolic gear is stripping.	Water intrusion. Cracked bearing bracket. Gear posts worn. Rusted helical gear at end of rotor. Worn gear case cover. Insufficient lubrication.		Use rain roof. Replace bearing bracket. Replace gear posts. Buff off rotor or replace rotor. Replace gear case. Lubricate with Aquashield®.

Troubleshooting continued – feed rate control

PROBLEM	POSSIBLE CAUSE	SOLUTION
Feed Rate Control		
Adjustment ring will not turn.	Variable cam has seized. Adjustment ring has seized.	Grease variable cam and cam slot. Clean and lubricate ring.
Adjustment ring turns, output doesn't change.	Variable cam has disengaged from ring. Variable cam is broken.	Re-insert 90° end into ring. Replace variable cam.
Pump head is not rotating.	Index plate is worn. Problem with the gear motor. Pump head roller assembly is stripped. Index pin holder backed out of spider assembly. Index pin is broken.	Turn over or replace index plate. Refer to Motor Section. Replace roller assembly. Tighten holder into spider assembly. Replace index pin and lifter assembly.
Pump head rotates continuously.	Variable cam is installed incorrectly.	Replace or re-insert variable cam.
Indexing is erratic.	Index plate is worn. Variable cam is worn. Lifter is worn.	Turn over or replace index plate. Replace variable cam. Replace index pin and lifter assembly.

Troubleshooting continued – pump head





PROBLEM	POSSIBLE CAUSE	SOLUTION
Pump Head		
Components are cracking.	Chemical attack.	Check chemical compatibility.
Visible fluid in pump head.	Pump tube rupture/leak.	Replace pump tube and ferrules and center tube.
No pump output; pump head rotates.	Depleted solution tank. Pump suction line weight is above solution. Suction line leak. Ferrules installed incorrectly or damaged. Injection point is clogged. Clogged suction/discharge tubing and/or injection check valve. Life of pump tube is exhausted.	Replenish solution. Maintain suction line 2 – 3" off bottom of tank. Inspect or replace suction line. Replace compression ferrules. Inspect and clean injection point. Clean and/or replace as necessary. Replace pump tube.
Low pump output; pump head rotates.	Pump tube is worn. Rollers missing or cracked. Injection point is restricted. High system back pressure.	Replace pump tube. Install new rollers or roller assembly. Inspect and clean injection point. Check tube psi rating against system pressure; replace accordingly.
No pump output; pump head not rotating.	Roller assembly is stripped. Feed Rate Control problem. Motor problem.	Replace roller assembly. Refer to Feed Rate Control section. Refer to Motor section.
Pump output is high.	Incorrect tube size. Roller assembly is broken. Malfunctioning Feed Rate Control. Incorrect model of motor.	Replace tube with correct size. Replace roller assembly. Refer to Feed Rate Control section. Replace with proper motor.

Troubleshooting continued – pump tube

PROBLEM	POSSIBLE CAUSE	SOLUTION
Pump Tube	 NOTICE: A leaking pump tube damages the metering pump. Inspect pump frequently for leakage and wear. Refer to Tube Replacement section for additional safety precautions and instructions.	
Tube is leaking.	Pump tube has ruptured. Calcium or mineral deposit. Excessive back pressure. Tube is twisted. Tube is not centered.	Replace pump tube at routine intervals. Clean injection fitting, replace pump tube. Check tube psi rating against system pressure; replace accordingly. Replace tube according to instructions. Replace tube and center it.
Tube life is shortened.	Chemical attack. Mineral deposit at injection point. Sediment blockage at check valve. Degraded check valve duckbill. Duckbill in wrong orientation. Tube was manually stretched to lock into discharge side slot. Seized rollers caused abrasion on tube.	Check chemical compatibility. Remove deposit and replace pump tube. Maintain suction line 2 – 3" above bottom of tank. Use a suction line strainer. Replace check valve duckbill at every tube change. Reverse duckbill orientation. See tube replacement instructions. Allow roller assembly to stretch tube into place. Clean roller assembly or replace.

Tube Replacement – safety information



WARNING RISK OF CHEMICAL EXPOSURE:

-  To reduce risk of exposure, check the pump tube regularly for leakage. At the first sign of leakage, replace the pump tube.
-  To reduce risk of exposure, the use of proper personal protective equipment is mandatory when working on or near chemical metering pumps.
-  To reduce risk of exposure, and also prior to service, shipping, or storage, pump generous amounts of water or a compatible buffer solution to remove chemical from pump.
-  Consult chemical manufacturer and MSDS sheet for additional information and precautions for the chemical in use.
-  Personnel should be skilled and trained in the proper safety and handling of the chemicals in use.





CAUTION PINCH POINT HAZARD:

-  Use extreme caution when replacing pump tube. Be careful of your fingers and DO NOT place fingers near rollers.

WARNING HAZARDOUS PRESSURE/CHEMICAL EXPOSURE:

-  Use caution and bleed off all resident system pressure prior to attempting service or installation.
-  Use caution when disconnecting discharge tubing from pump. Discharge may be under pressure. Tubing may contain chemical.

NOTICE: Indicates special instructions or general mandatory action.

-  **NOTICE:** Do not apply grease, oil, or lubricants to the pump tube or housing.
-  **NOTICE:** Prior to pump tube replacement, inspect the entire pump head for cracks or damaged components. Ensure rollers turn freely.
-  **NOTICE:** Rinse off chemical residual and clean all chemical and debris from pump head components prior to tube replacement. Apply Stenner grease to main shaft and tube housing cover bushing during tube replacement.
-  **NOTICE:** DO NOT pull excessively on pump tube. Avoid kinks or damage during tube installation.
-  **NOTICE:** Inspect the suction/discharge tubing, injection point (into pipe), and injection check valve duckbill for blockages after any tube rupture. Clear or replace as required.

Tube Replacement continued – preparation

1. Follow all safety precautions prior to tube replacement.
2. Prior to service, pump water or a compatible buffer solution through the pump and suction/discharge line to remove chemical and avoid contact.
3. Turn pump off.
4. Disconnect the suction and discharge connections from pump head.
5. Plug power cord into constantly energized, properly grounded receptacle for service.

Tube Replacement continued – remove old tube

REMOVE OLD TUBE

1. Remove and set aside cover and screws.
2. Set feed rate dial on the low setting until finished.
3. Turn pump on and let it run until one of three roller assembly slots lines up with the tube fitting on the suction side.
Illustration A
4. Turn pump off.
5. Lift tube fitting out of housing slot and pull it toward center of roller assembly.
Illustration B
6. Turn pump on and allow roller assembly to jog while guiding tube, with tension, up and out of housing. **Illustration C**
7. Turn pump off. Remove and discard pump tube.
8. Remove roller assembly, shaft, and housing.
9. Use non-citrus all-purpose cleaner to clean chemical residue from pump head housing, roller, and cover.
10. Check housing for cracks. Replace if cracked.
11. Ensure rollers spin freely. **Illustration D**
12. Replace roller assembly if: seized, excessive side play from bore wear, or if rollers are visibly worn.
13. Reinstall clean tube housing.
14. Grease shaft tip and install.
15. Install roller assembly.

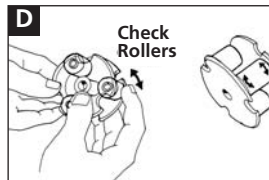
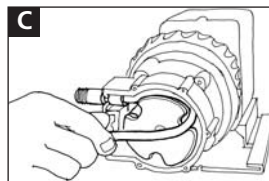
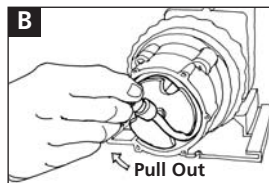
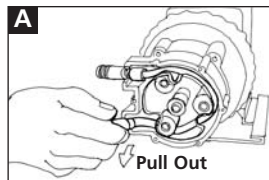

Tube Replacement continued – install new tube

IMPORTANT! Do not lubricate pump tube or roller assembly.

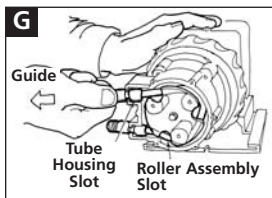
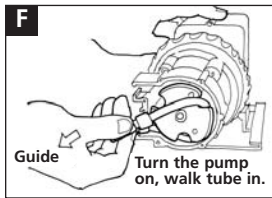
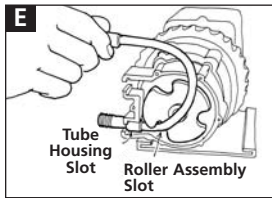

NOTE: Cover Screws are self-tapping and must be backed in to locate original thread before securing. If a screw boss is stripped, use alternate bosses and position opposite from each other. Never secure the cover plate with more than 2 screws.

INSTALL NEW TUBE

1. By manually rotating the roller assembly counter clockwise, align one of three roller assembly slots with the suction side housing slot.
2. Place tube fitting into suction side slot of the housing and the roller assembly slot.

Illustration E

3. With pump setting on low, hold tube fitting and jog roller assembly by turning pump on.

IMPORTANT! Avoid rotating wrist, which can result in a twisted tube that will not center. Do not force tube and be careful of your fingers.

4. Guide tube, with slight tension (toward the center) to prevent pinching between housing and roller assembly. *Illustration F*

5. When tube reaches the top housing slot, turn pump off.
6. Turn dial ring to setting 10, hold tube fitting firmly, and turn pump on.

NOTE: An old tube will stretch approximately 3/4" and the new tube will appear to be stiff and short. Follow directions to allow rollers to stretch tube into place.

7. Allow rollers to stretch tube into place while guiding tube into slot. *Illustration G*
8. Turn pump off.
9. Apply a small amount of grease (AquaShield®) to cover bushing **ONLY** and replace cover and two screws, leaving front screw in-between the fittings loose.

Tube Replacement continued – center new tube

CENTER NEW TUBE

1. To center pump tube on rollers, set feed rate dial to setting 10. Turn pump on.
Illustration H
2. Turn the tube fitting on the suction side not more than 1/8 of a turn in the direction tube must move.
3. Do not let go of fitting until tube rides approximately in center of rollers.
4. Turn pump off, let go of fitting, and tighten cover screws. Cover is not on securely if there is a gap between screw boss and cover.

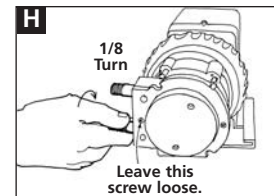

TUBE CHANGE FOR FIXED OUTPUT PUMP

1. To install a new tube in a fixed output pump, follow the instructions above and utilize the on/off switch to jog the roller assembly in the absence of the feed rate control. **Illustration I**

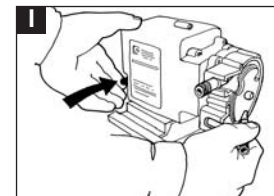

Motor – exploded view

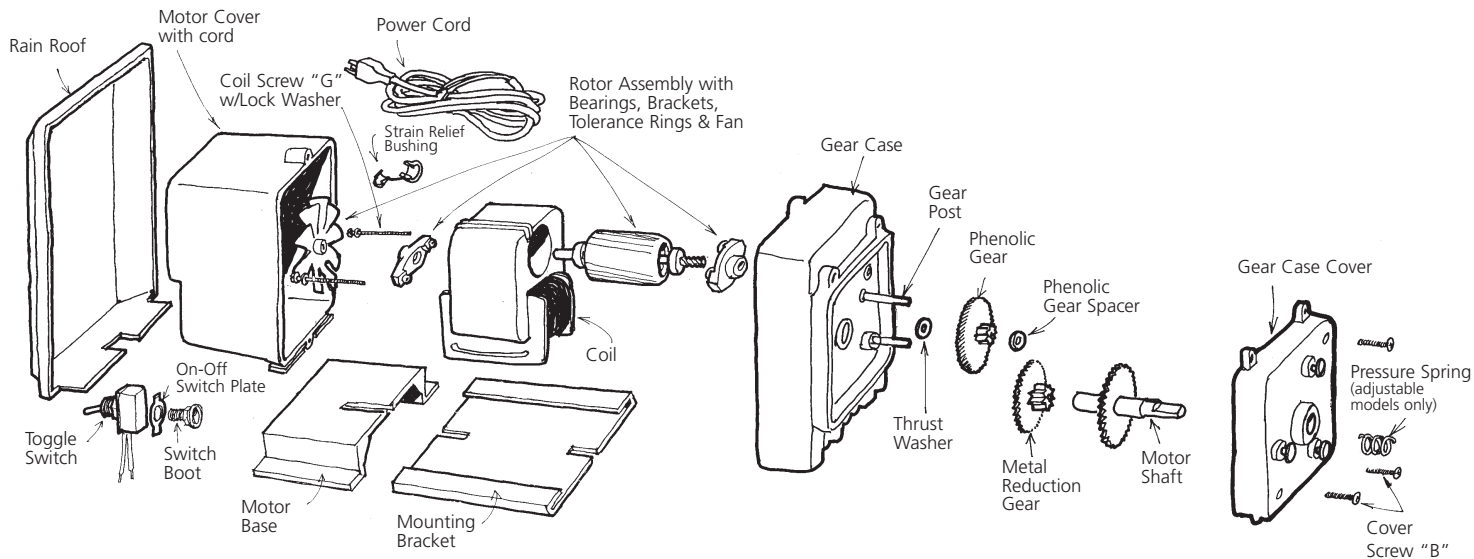

Contact factory for part numbers.

Motor continued – subassemblies

MOTORS

DESCRIPTION	PART NUMBER	UM	PART NUMBER	UM
Motor 60Hz (adjustable output 45 & 100 series)	(120v) PM6041D	EA	(220v) PM6042D	EA
Motor 60Hz (adjustable output 85 & 170 series)	(120v) PM6081D	EA	(220v) PM6082D	EA
Motor 60Hz (fixed output 45MP series only)	(120v) ME6041D	EA	(220v) ME6042D	EA
Motor 60Hz (fixed output 85MP series only)	(120v) ME6081D	EA	(220v) ME6082D	EA
Motor 60Hz (fixed output 100DMP series only)	(120v) DM6041D	EA	(220v) DM6042D	EA
Motor 60Hz (fixed output 170DMP series only)	(120v) DM6081D	EA	(220v) DM6082D	EA

EUROPE

Motor 50Hz (adjustable output 45 & 100 series)	(230v) PM64230	EA	(250v) PM6426D	EA
Motor 50Hz (adjustable output 85 & 170 series)	(230v) PM68230	EA	(250v) PM6826D	EA
Motor 50Hz (fixed output 45MP series only)	(230v) ME64230	EA	(250v) ME6426D	EA
Motor 50Hz (fixed output 85MP series only)	(230v) ME68230	EA	(250v) ME6826D	EA
Motor 50Hz (fixed output 100DMP series only)	(230v) DM64230	EA	(250v) DM64250	EA
Motor 50Hz (fixed output 170DMP series only)	(230v) DM68230	EA	(250v) DM68250	EA

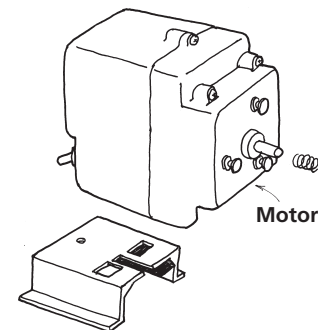

Motor continued – service kits

Motor Service Kit

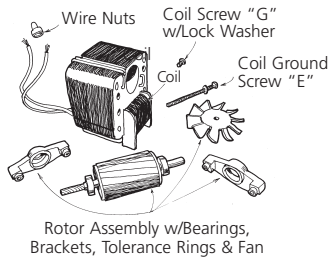

MOTOR SERVICE KITS

DESCRIPTION	PART NUMBER	UM	PART NUMBER	UM
Motor Service Kit 60Hz	(120v) MSK120	Kit	(220v) MSK220	Kit

GEAR CASE SERVICE KITS

DESCRIPTION	PART NUMBER	UM
Gear Case Service Kit (adjustable output 45 & 100)	GSK45A	Kit
Gear Case Service Kit (adjustable output 85 & 170)	GSK85A	Kit
Gear Case Service Kit (fixed output 45MP series only)	GSK45F	Kit
Gear Case Service Kit (fixed output 85MP series only)	GSK85F	Kit

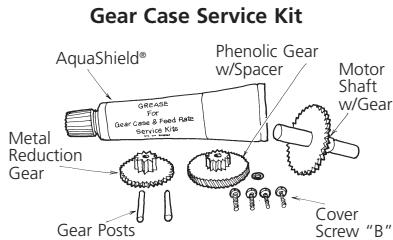

Feed Rate Control – exploded view

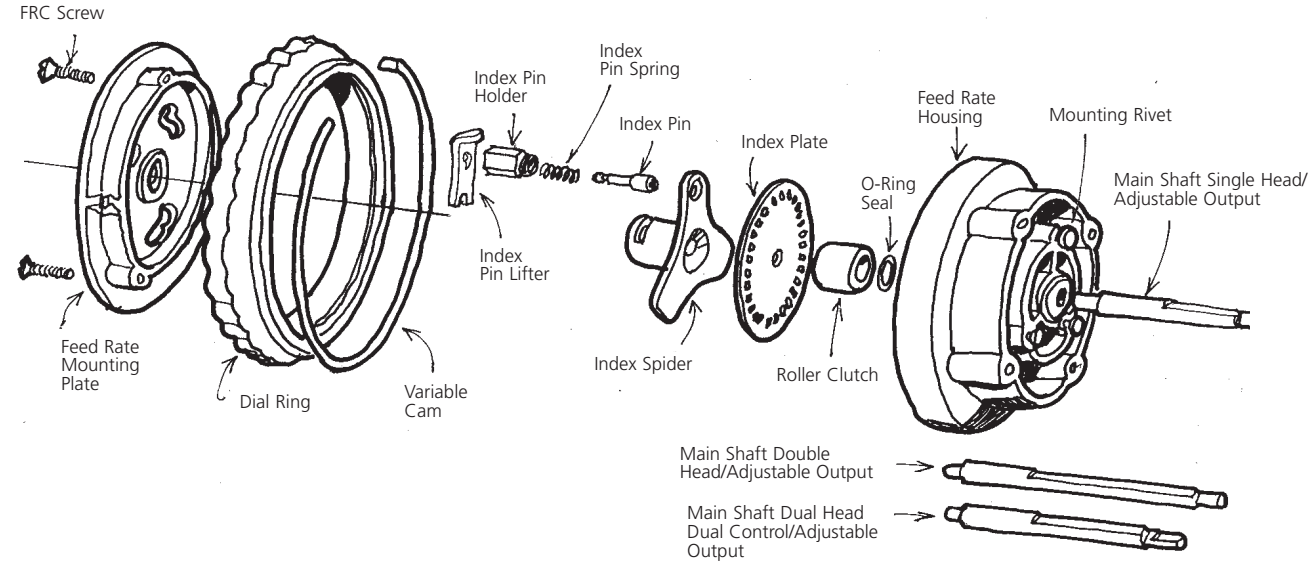

Contact factory for part numbers.

US and Canada call 1-800-683-2378, other countries call 1-904-641-1666

Feed Rate Control continued – subassemblies & service kits

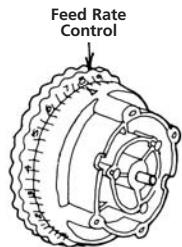

FEED RATE CONTROLS

DESCRIPTION	PART NUMBER	UM
Feed Rate Control w/ shaft (single head – 45/85 adjustable)	FC5040D	EA
Feed Rate Control w/ shaft (double head – 100/170 adjustable)	DM5040D	EA
Feed Rate Control w/shaft (dual head dual control – 100/170MDC)	DM504DC	EA

Feed Rate Control Service Kit

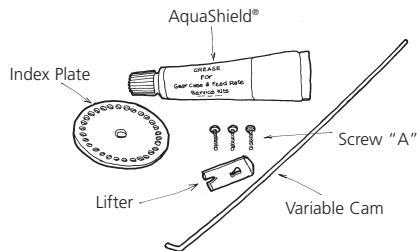

FEED RATE CONTROL SERVICE KIT

DESCRIPTION	PART NUMBER	UM
Feed Rate Control Service Kit	FSK100	Kit

Pump Head – exploded view

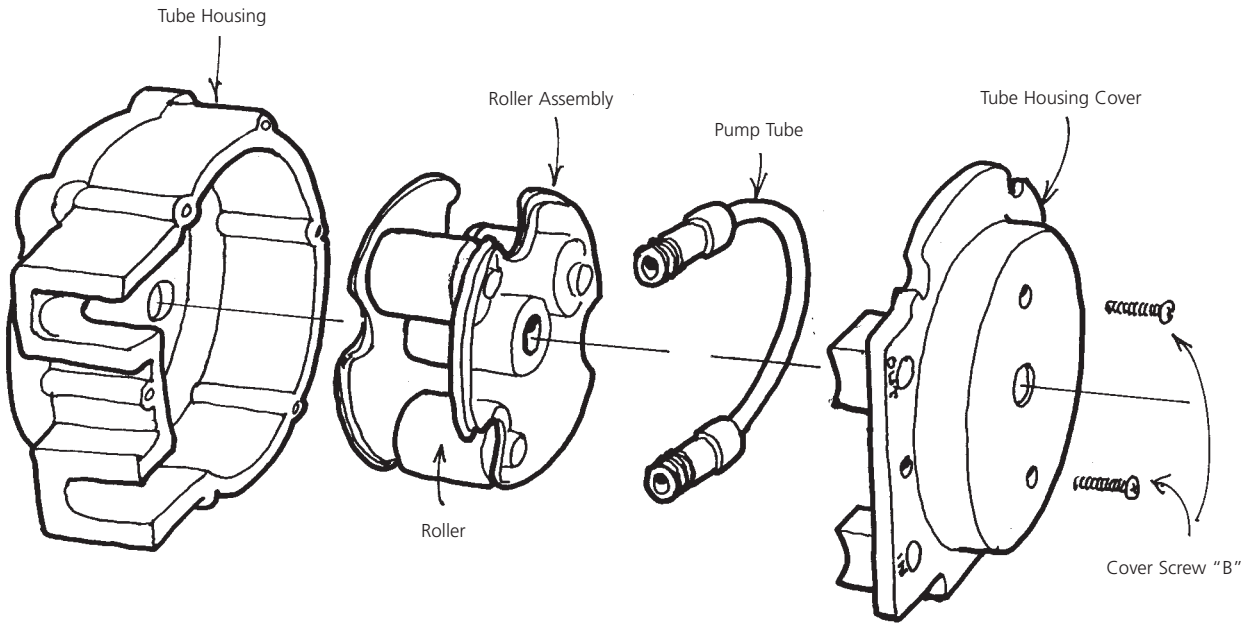

Contact factory for part numbers.

Pump Head continued – subassemblies

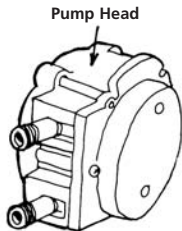

Pump Tube Numbers

#1 and #2 for 26-100 psi pump (when used with check valve).

#1, 2, 3, 4, 5 for 25 psi pump.

#7 tube for 26-100 psi single head pump only.

PUMP HEADS

DESCRIPTION	PART NUMBER	UM	PART NUMBER	UM
Pump Head includes SANTOPRENE® pump tube, ferrules 1/4"	UCTHC_*_D	EA	MCTHC_*_D	PK of 2
	* select tube number 1, 2, 3, 4, 5, 7			
Pump Head includes SANTOPRENE® pump tube & duckbill, ferrules 1/4"	UCPH_*_FD	EA	n/a	n/a
	* select tube number 1, 2, 7			
Pump Head includes TYGOTHANE® pump tube, ferrules 1/4"	UCPHT0_*	EA	n/a	n/a
	* select tube number 2, 5			
Pump head includes TYGOTHANE® #2 pump tube, PELLATHANE® duckbill, ferrules 1/4"	UCPHTD2	EA	n/a	n/a

EUROPE

Pump Head includes SANTOPRENE® pump tube, ferrules 6mm	UCTH_*_CE	EA	MCTH_*_CE	PK of 2
	* select tube number 1, 2, 3, 4, 5, 7			
Pump Head includes SANTOPRENE® pump tube & duckbill, ferrules 6mm	UCPH_*_CE	EA	n/a	n/a
	* select tube number 1, 2, 7			
Pump Head includes TYGOTHANE® pump tube, ferrules 6mm	UCPHT_*_CE	EA	n/a	n/a
	* select tube number 2, 5			
Pump head includes TYGOTHANE® #2 pump tube, PELLATHANE® duckbill, ferrules 6mm	UCPHD2CE	EA	n/a	n/a

Pump Head continued – service kits

PUMP HEAD SERVICE KITS

DESCRIPTION	PART NUMBER	UM
SANTOPRENE® Kit (25 psi)	PSKLO_*	KIT
	* select tube number 1, 2, 3, 4, 5	
SANTOPRENE® Kit (26 - 100 psi)	PSKH0_*	KIT
	* select tube number 1, 2, 7	
TYGOTHANE® Kit (25 psi)	PSKLT_*	KIT
	* select tube number 2 or 5	
KIT: (26-100 psi) TYGOTHANE® #2 Pump Tube & PELLATHANE® duckbill included	PSKHT2	KIT

EUROPE

SANTOPRENE® Kit (1.7 bar)	PSKL_*_CE	KIT
	* select tube number 1, 2, 3, 4, 5	
SANTOPRENE® Kit (1.7-6.9 bar)	PSKH_*_CE	KIT
	* select tube number 1, 2, 7	
TYGOTHANE® Kit (1.7 bar)	PSKLT_*_CE	KIT
	* select tube number 2 or 5	
KIT: TYGOTHANE® #2 Pump Tube & PELLATHANE® duckbill included	PSKHT2CE	KIT

0-25 psi/1.7 bar

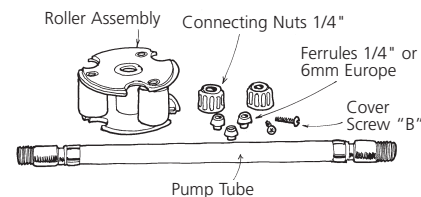

26-100 psi/6.9 bar

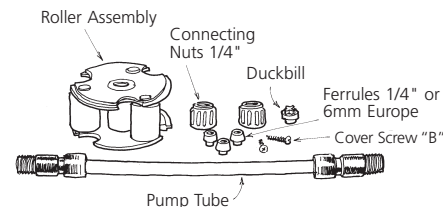

Adapter Pump Heads – subassemblies

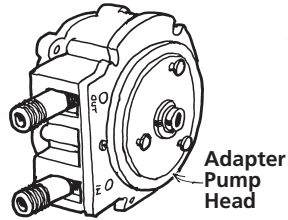

ADAPTER PUMP HEADS

DESCRIPTION	PART NUMBER	UM	PART NUMBER	UM
Adapter Pump Head includes SANTOPRENE® pump tube, ferrules 1/4"	UC1ATC_*	EA	MC1ATC_*	PK of 2
	* select tube number 1, 2, 3, 4, 5			
Adapter Pump Head includes SANTOPRENE® pump tube & duckbill, ferrules 1/4"	UCAH_*_FD	EA	n/a	n/a
	* select tube number 1, 2			
Adapter Pump Head includes TYGOTHANE® pump tube, ferrules 1/4"	UCAHT0_*	EA	n/a	n/a
	* select tube number 2, 5			
Adapter Pump Head includes #2 TYGOTHANE® pump tube PELLATHANE® duckbill, ferrules 1/4"	UCAHTD2	EA	n/a	n/a

EUROPE

Adapter Pump Head includes SANTOPRENE® pump tube, ferrules 6mm	UCAP_*_CE	EA	MCAP_*_CE	PK of 2
	* select tube number 1, 2, 3, 4, 5			
Adapter Pump Head includes SANTOPRENE® pump tube & duckbill, ferrules 6mm	UCAH_*_CE	EA	n/a	n/a
	* select tube number 1, 2			
Adapter Pump Head includes TYGOTHANE® pump tube, ferrules 6mm	UCAT_*_CE	EA	n/a	n/a
	* select tube number 2, 5			
Adapter Pump Head includes #2 TYGOTHANE® pump tube, PELLATHANE® duckbill, ferrules 6mm	UCT2DCE	EA	n/a	n/a

Pump Tubes

PUMP TUBES

DESCRIPTION	PART NUMBER	UM	PART NUMBER	UM
SANTOPRENE® Pump Tube includes ferrules 1/4"	UCCP20_*	PK of 2	MCCP20_*	PK of 5
	* select tube number 1, 2, 3, 4, 5, 7			
SANTOPRENE® Pump Tube & duckbill , ferrules 1/4"	UCCP_*_FD	PK of 2	n/a	n/a
	* select tube number 1, 2, 7			
TYGOTHANE® Pump Tube , ferrules 1/4"	UCTYG0_*	PK of 2	MCTYG0_*	PK of 5
	* select tube number 2, 5			
TYGOTHANE® #2 Pump Tube & PELLATHANE® duckbill , ferrules 1/4"	UCTY2FD	PK of 2	n/a	n/a

EUROPE

SANTOPRENE® Pump Tube includes ferrules 6mm	UCCP2_*_CE	PK of 2	MCCP2_*_CE	PK of 5
	* select tube number 1, 2, 3, 4, 5, 7			
SANTOPRENE® Pump Tube & duckbill , ferrules 6mm	UC_*_FDCE	PK of 2	n/a	n/a
	* select tube number 1, 2, 7			
TYGOTHANE® Pump Tube includes ferrules 6mm	UCTY_*_CE	PK of 2	MCTY_*_CE	PK of 5
	* select tube number 2, 5			
TYGOTHANE® #2 Pump Tube & PELLATHANE® duckbill , ferrules 6mm	UCTY2DCE	PK of 2	n/a	n/a

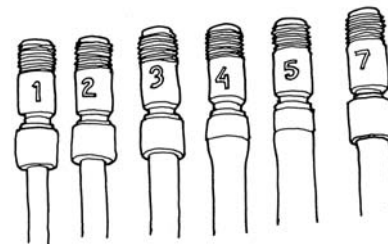

Pump Tube Numbers

#1 and #2 for 26-100 psi pump
(when used with check valve).

#1, 2, 3, 4, 5 for 25 psi pump.

#7 tube for 26-100 psi single
head pump only.

Check Valves

Injection Check Valve 1/4"



Injection Check Valve 3/8"



Injection Check Valve 6mm



CHECK VALVES

DESCRIPTION	PART NUMBER	UM	PART NUMBER	UM
Check Valve includes SANTOPRENE® duckbill, ferrules 1/4"	UCDBINJ	EA	MCDBINJ	PK of 5
Check Valve includes PELLATHANE® duckbill, ferrules 1/4"	UCTYINJ	EA	MCTYINJ	PK of 5
Check Valve includes SANTOPRENE® duckbill, ferrules 3/8"	UCINJ38	EA	MCINJ38	PK of 5
Check Valve includes PELLATHANE® duckbill, ferrules 3/8"	UCTYIJ38	EA	MCTYIJ38	PK of 5
EUROPE				
Check Valve includes SANTOPRENE® duckbill, ferrules 6mm	UCINJCE	EA	MCINJCE	PK of 5
Check Valve includes PELLATHANE® duckbill, ferrules 6mm	UCTINJCE	EA	MCTINJCE	PK of 5

For Your Records

Model: _____

Serial Number: _____

Date of Installation: _____



STENNER

Metering Pumps
Manufactured Since 1957

**3174 DeSalvo Road
Jacksonville, Florida 32246
sales@stenner.com
www.stenner.com**

Phone: 904.641.1666
US Toll Free: 800.683.2378
Fax: 904.642.1012

Hours of Operation (EST):
Mon. – Thu. 7am – 5pm
Friday 7am – Noon