



ECP Series Glass Filled Polypropylene Electric Actuators

FOR BALL VALVES 1/2" - 6"

BUTTERFLY VALVES 2" - 6"

KEY FEATURES

- Ideal for Corrosive Atmosphere and Environments
- Corrosion-Resistant GFPP Housing
- LED Status Light
- Anti-Condensation Heater
- Manual Override
- Position Indicator
- 4 SPDT Micro Limit Switches
- Lightweight - Easy for Installation
- ISO 5211 Mounting Base
- Stainless Steel Fasteners 303 SS
- 100% Factory Tested
- CE Mark
- Thermal Overload Protection
- Auto Switching Power Supply

OPTIONS

- Digital Positioner 4-20mA or 2-10V
- Battery Fail Safe Kit

TECHNICAL INFORMATION

EXPLODED VIEW

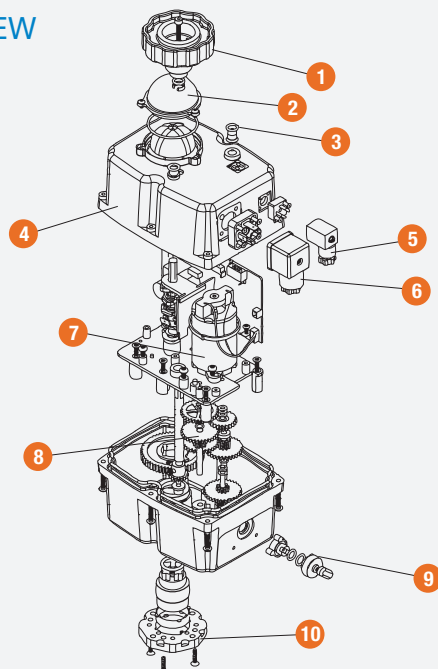

SPECIFICATIONS

OPERATION	1/4 Turn
DUTY RATING	75%
ENCLOSURE	NEMA 4 / 4X
PROTECTION	IP67 265
VOLTAGE	Single Phase 24V~V AC/DC
HOUSING	GFPP (Glass Filled Polypropylene) per 314ASTM D4101 Cell Class 85580
OUTPUT SHAFT	303 Stainless Steel per ASTM A314

ECP Series Electric Actuators

FOR BALL VALVES 1/2" - 6" AND BUTTERFLY VALVES 2" - 6"

TECHNICAL INFORMATION, CONTINUED

PARTS LIST

- | | |
|-----------------------------------|----------------------------|
| 1. Manual Override | 6. Power DIN Connector |
| 2. Position Indicator Assembly | 7. DC Drive Motor |
| 3. LED Indicator | 8. Hardened Steel Gear Set |
| 4. Housing | 9. Declutch Lever |
| 5. Auxiliary Switch DIN Connector | 10. ISO5211 Mount Plate |

DIMENSIONS

MODEL	A in / mm	B in / mm	C in / mm	ISO PATTERN
ECP3	6.96 / 177	6.73 / 171	4.33 / 110	F05 X 14 mm
ECP5	6.96 / 177	7.72 / 196	4.33 / 110	F07 X 14 mm
ECP8	6.96 / 177	7.72 / 196	4.33 / 110	F07 X 14 mm

ACTUATOR SPECIFICATIONS

	ECP3	ECP5	ECP8
Torque Output (in / lbs / Nm)	359 / 40	530 / 60	796 / 90
Enclosure Material	Glass Filled Polypropylene		
Output Shaft	303 Stainless Steel		
Cycle Time	11 sec.	14 sec.	30 sec.
Operating Temperature	4° F to 160° F / 16° C to 71° C		
Weight (lbs / kg)	1.90 / 0.86	2.40 / 1.09	3.00 / 1.36

VALVE SELECTION CHART

VALVE TYPE	SIZE	ECP3	ECP5	ECP8
TB / TBH Series Ball Valves	1/2"	•		
	3/4"	•		
	1"	•		
	1-1/4"	•		
	1-1/2"	•		
	2"	•	•	•
TW/LA Series Three Way Valves	2-1/2" - 3"	•	•	•
	4" - 6"	•	•	•
	1/2"	•		
	3/4"	•		
	1"	•		
	1-1/4"	•	•	
BYV Series Butterfly Valves	1-1/2"	•	•	
	2"	•	•	•
	2-1/2" - 3"	•	•	•
	4" - 6"	•	•	•
	2"	•		
	3"	•		
	4"		•	
	6"			•

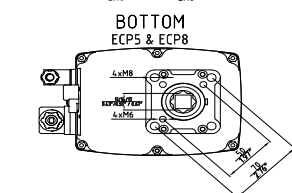
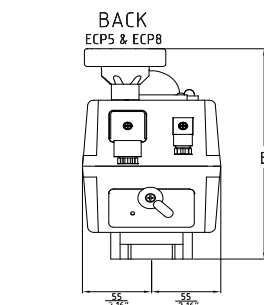
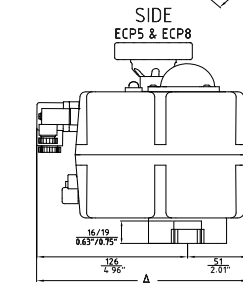
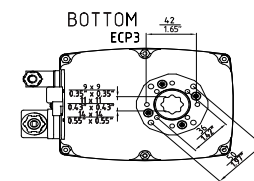
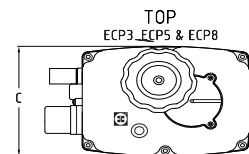
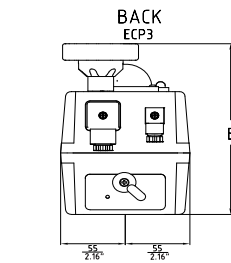
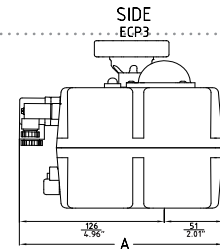

Hayward is a registered trademark of Hayward Industries, Inc. © 2018 Hayward Industries, Inc.

USA: 1.888.429.4635 • Fax: 1.888.778.8410 • One Hayward Industrial Drive • Clemmons, NC 27012 • Email: hfcsales@hayward.com
 Canada: 1.888.238.7665 • Fax: 1.905.829.3636 • 2880 Plymouth Drive • Oakville, ON L6H 5R4 • Email: hfcanada@hayward.com
 Visit us at: haywardflowcontrol.com