

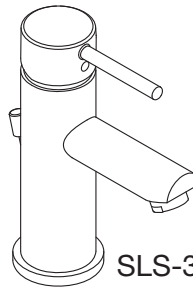

Location:

SLS-3512-1.5, SLS-3510-1.5  
Single Handle Lavatory Faucet  
**Specification Submittal**





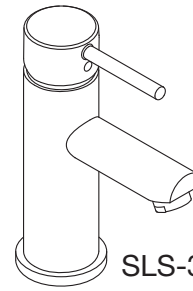

SLS-3512-1.5



SLS-3510-1.5



Model Numbers	Feature Highlights
<input type="checkbox"/> <b>SLS-3512-1.5</b> <i>Single Handle Lavatory Faucet with lift rod and metal drain assembly</i> <input type="checkbox"/> <b>SLS-3510-1.5</b> <i>Single Handle Lavatory Faucet, lift rod and drain not included</i>	<ul style="list-style-type: none"> <li>• Single hole mount configuration</li> <li>• Quarter turn ceramic cartridge</li> <li>• 23 inch braided hose water supply connections</li> <li>• 7-1/8" height</li> <li>• Lift rod and metal drain assembly (SLS-3512-1.5)</li> <li>• Standard 1.5 gpm (5.7 L/min) flow rate</li> <li>• Faucet shall be metal construction, plated in standard polished chrome finish</li> </ul>
Finish Options/Modifications	Compliance
<input type="checkbox"/> <b>-0.5</b>  <i>0.5 gpm (1.9 L/min) flow restrictor</i> <input type="checkbox"/> <b>-1.0</b>  <i>1.0 gpm (3.8 L/min) flow restrictor</i> <input type="checkbox"/> <b>Delete Suffix 1.5</b> <i>2.2 gpm (8.3 L/min) flow restrictor</i> <input type="checkbox"/> <b>-DP4</b> <i>4" deck plate</i> <input type="checkbox"/> <b>-G</b> <i>Grid drain</i> <input type="checkbox"/> <b>-BBZ</b> <i>Brushed Bronze finish</i> <input type="checkbox"/> <b>-MB</b> <i>Matte Black finish</i> <input type="checkbox"/> <b>-STN</b> <i>Satin Nickel finish</i>	<p>-ASME A112.18.1/CSA B125.1          -NSF/ANSI 61.9; NSF/ANSI 372          -WaterSense 1.0 gpm, 1.5 gpm</p>  
<p><b>Note:</b> Append appropriate -suffix to model number.</p>	Warranty
<p><b>Limited Lifetime</b> - to the original end purchaser in consumer/residential installations.  <b>5 Years</b> - for industrial/commercial installations.          Refer to <a href="http://www.symmons.com/warranty">www.symmons.com/warranty</a> for complete warranty information.</p>	

## Dimensions

### Notes:

- (1) Dimensions subject to change without notice
- (2) Lift rod included with model SLS-3512 only

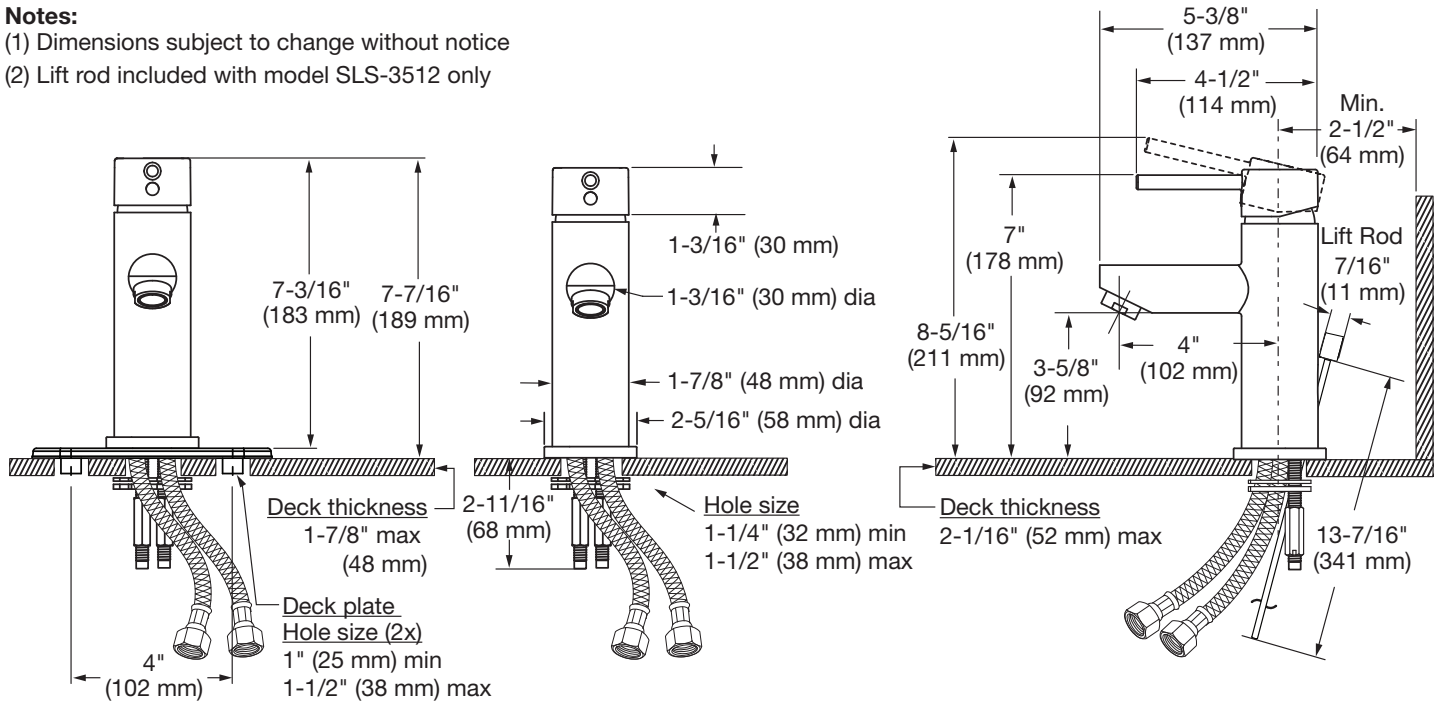





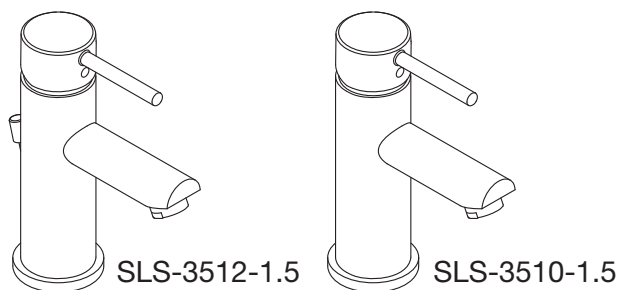

Ubicación:



SLS-3512-1.5, SLS-3510-1.5  
Grifo para lavabo con una sola manija  
**Presentación de especificaciones**

Números de modelo	Características destacadas
<input type="checkbox"/> <b>SLS-3512-1.5</b> <i>Grifo para lavabo con una sola manija con varilla de levantamiento y conjunto de desagüe metálico</i> <input type="checkbox"/> <b>SLS-3510-1.5</b> <i>Grifo para lavabo con una sola manija, varilla de levantamiento y desagüe no incluidos</i>	<ul style="list-style-type: none"> <li>• Configuración de montura en un solo orificio</li> <li>• Cartucho de cerámica con un cuarto de vuelta</li> <li>• Manguera trenzada de 23 pulgadas con conexiones para suministro de agua</li> <li>• 7-1/8" de altura</li> <li>• Varilla de levantamiento y conjunto de desagüe metálico (SLS-3512-1.5)</li> <li>• Caudal estándar de 1.5 gal/min (5.7 L/min)</li> <li>• El grifo será de materiales metálicos, revestidos con un acabado cromado pulido estándar.</li> </ul>
Opciones / Modificaciones de acabado	Cumplimiento
<input type="checkbox"/> <b>-0.5</b>  <i>Reductor de caudal de 0.5 gal/min (1.9 L/min)</i> <input type="checkbox"/> <b>-1.0</b>  <i>Reductor de caudal de 1.0 gal/min (3.8 L/min)</i> <input type="checkbox"/> <b>Eliminar sufijo 1.5</b> <i>Reductor de caudal de 2.2 gal/min (8.3 L/min)</i> <input type="checkbox"/> <b>-DP4</b> <i>Placa de cubierta de 4"</i> <input type="checkbox"/> <b>-G</b> <i>Desagüe en rejilla</i> <input type="checkbox"/> <b>-BBZ</b> <i>Acabado en bronce cepillado</i> <input type="checkbox"/> <b>-MB</b> <i>Acabado en negro mate</i> <input type="checkbox"/> <b>-STN</b> <i>Acabado en níquel satinado</i>	<p>-ASME A112.18.1/CSA B125.1          -NSF/ANSI 61.9; NSF/ANSI 372          -WaterSense 1.0 gal/min, 1.5 gal/min</p>  
<p><b>Nota:</b> Anexar el -sufijo apropiado al número de modelo.</p>	Garantía
<p><b>Limitada de por vida</b> - para el comprador original del producto en establecimientos del consumidor/residenciales.  <b>5 años</b> - para instalaciones industriales y comerciales.          Consulte <a href="http://www.symmons.com/warranty">www.symmons.com/warranty</a> para obtener información completa sobre la garantía.</p>	

## Dimensiones

### Notas:

- (1) Las dimensiones pueden cambiar sin previo aviso
- (2) La varilla de levantamiento solamente se incluye con el modelo SLS-3512

