

CASSIDY™

Models/Modelos/Modèles 9197T-DST & 9997T-DST

For models produced after 01/01/2018 see pages 1 & 2.
For models produced before 01/01/2018 see pages 3 & 4.

Para los modelos producidos después del 01/01/2018, consulte las páginas 1 y 2.
Para los modelos producidos antes del 01/01/2018, consulte las páginas 3 y 4.

Pour les modèles produits après le 01/01/2018, voir pages 1 et 2.
Pour les modèles produits avant le 01/01/2018, voir pages 3 et 4.

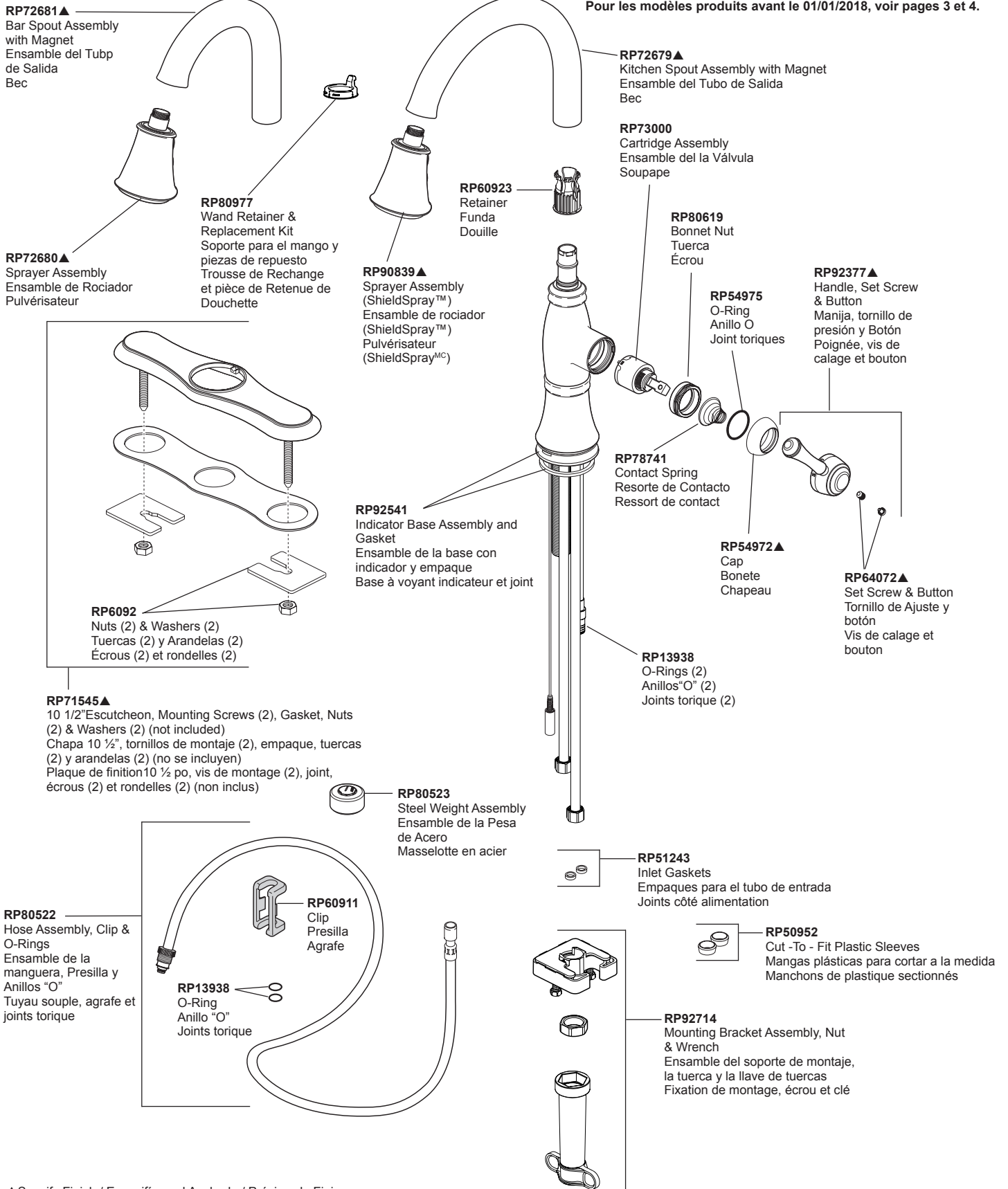

▲Specify Finish / Especificque el Acabado / Précisez le Fini

EP92546
Solenoid Assembly
Ensamble de Solenoide
Électrovanne

For PC, SS, AR & KS finishes, order **EP92546**
For BL, MW, RB & SP finishes, order **EP92546XX**

Para acabados PC, SS, AR y KS, ordene **EP92546**
Para acabados BL, MW, RB y SP, ordene **EP92546XX**

Pour les finis PC, SS, AR et KS, commandez **EP92546**
Pour les finis BL, MW, RB et SP, commandez **EP92546XX**

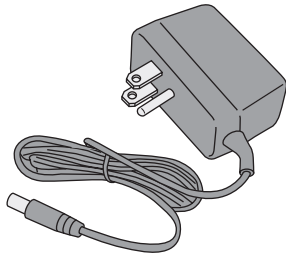

EP73954
9 Volt Power Supply
(Accessory Order Only)
Fuente de alimentación de 9 voltios
(Orden de accesorios solamente)
Alimentation électrique 9 volts
(L'accessoire seulement)

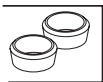

RP50952
Cut -To - Fit Plastic Sleeves
Casquillos cortados a la medida
Bagues d'extrémité pour
tubes coupés

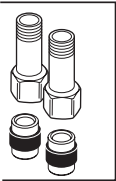

RP53468
Check Valves
Válvulas Checadoras
Clapets de non-retour

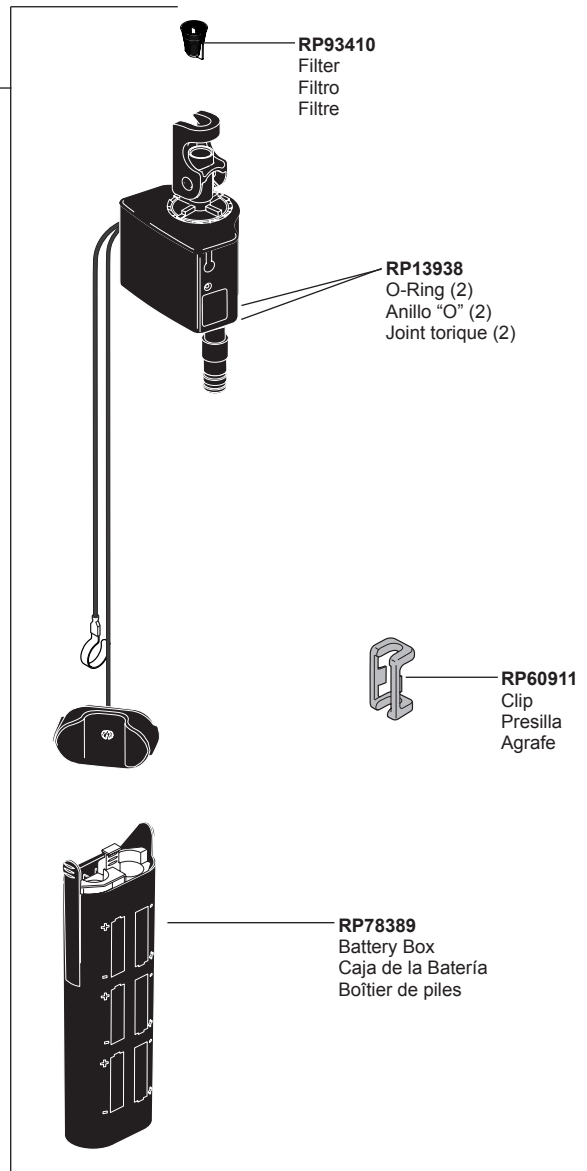

RP93410
Filter
Filtro
Filtre

RP13938
O-Ring (2)
Anillo "O" (2)
Joint torique (2)



RP60911
Clip
Presilla
Agrafe

RP78389
Battery Box
Caja de la Batería
Boîtier de piles

Other useful accessories that may be purchased separately.
Otros accesorios útiles que se pueden comprar por separado.
Autres accessoires utiles pouvant être achetés séparément.

RP63263
Adapters
3/8"-24 UNEF to 1/2"-20 UN &
3/8"-24 UNEF to 1/2"-14 NPSM
Adaptadors
3/8"-24 UNEF a 1/2"-20 UN &
3/8"-24 UNEF a 1/2"-14 NPSM
Adaptateurs
3/8 po-24 UNEF à 1/2 po-20 UN et
3/8 po-24 UNEF à 1/2 po-14 NPSM

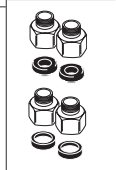

RP63264
Adapters (10) 3/8"-24 UNEF to 1/2"-20 UN
Adaptadors (10) 3/8"-24 UNEF a 1/2"-20 UN
Adaptateurs (10) 3/8 po-24 UNEF à 1/2 po-20 UN



RP63265
Adapters (10) 3/8"-24 UNEF to 1/2"-14 NPSM
Adaptadors (10) 3/8"-24 UNEF a 1/2"-14 NPSM
Adaptateurs (10) 3/8 po-24 UNEF à 1/2 po-14 NPSM



CASSIDY™

Models/Modelos/Modèles
9197T-DST & 9997T-DST

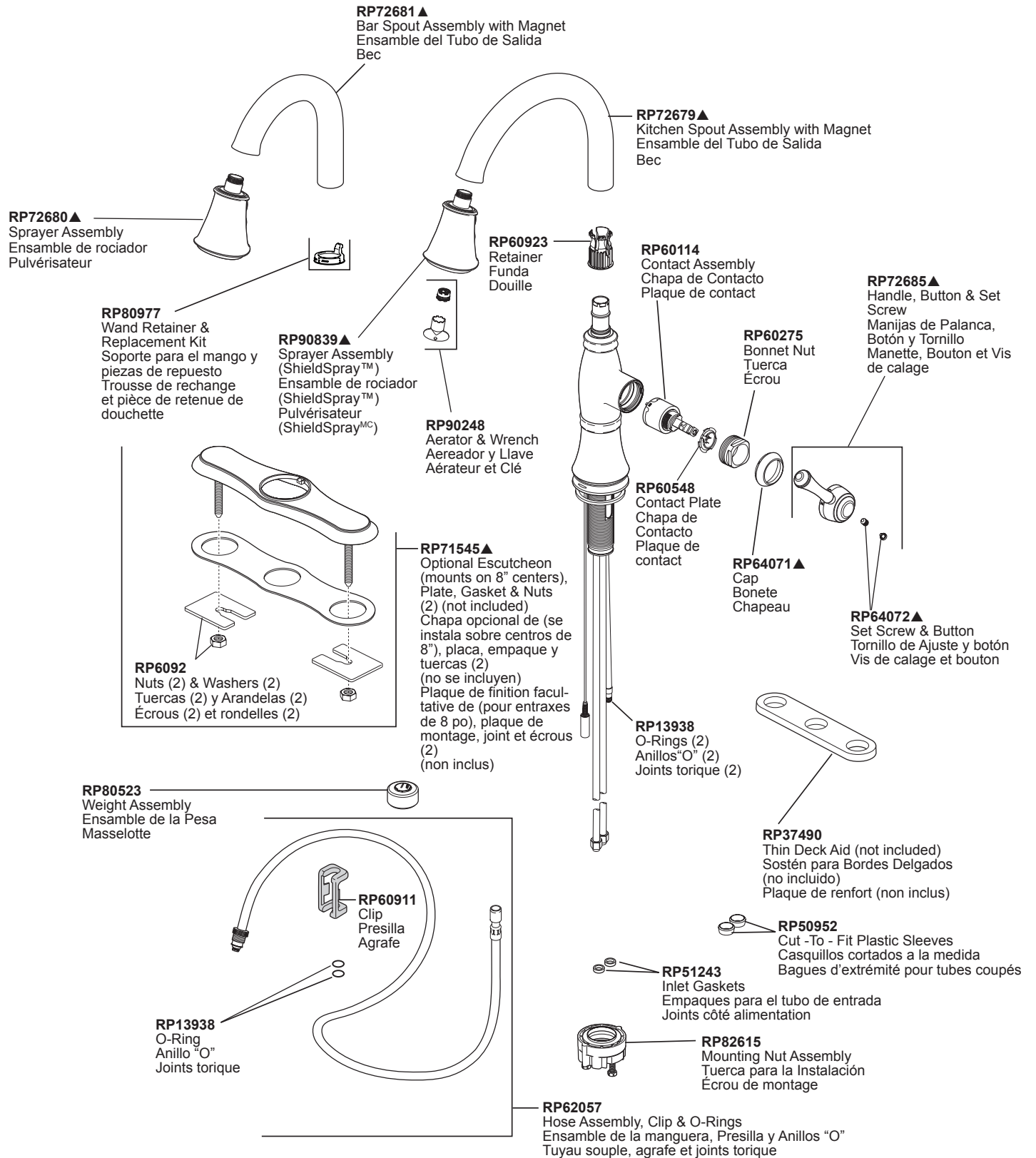

▲Specify Finish / Especificque el Acabado / Précisez le Fini

EP74855 ■
Solenoid Assembly
Ensamble de Solenoïde
Électrovanne

■ For PC, CZ, AR & SS finishes order EP74855.
For BL & RB finishes order EP74855XX

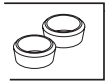

RP50952
Cut -To - Fit Plastic Sleeves
Casquillos cortados a la medida
Bagues d'extrémité pour tubes coupés

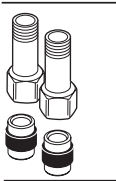

RP53468
Check Valves
Válvulas Checadoras
Clapets de non-retour

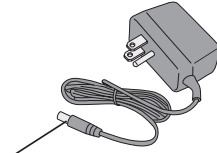

EP73954
9 Volt Power Supply
(Accessory Order Only)
Fuente de alimentación de 9 voltios
(Orden de accesorios solamente)
Alimentation électrique 9 volts
(L'accessoire seulement)

RP47888
Pump & Bottle
Bomba y Botella
Pompe et Bouteille

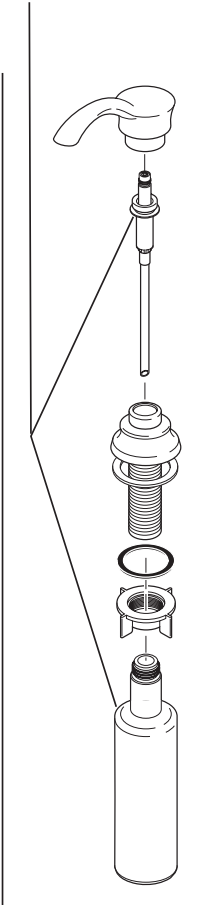

RP71543 ▲
Soap Dispenser
(Accessory Order Only)
Dispensador de jabón
(Orden de Accesorio Solamente)
Distributeur de savon
(Livrablé séparément seulement)

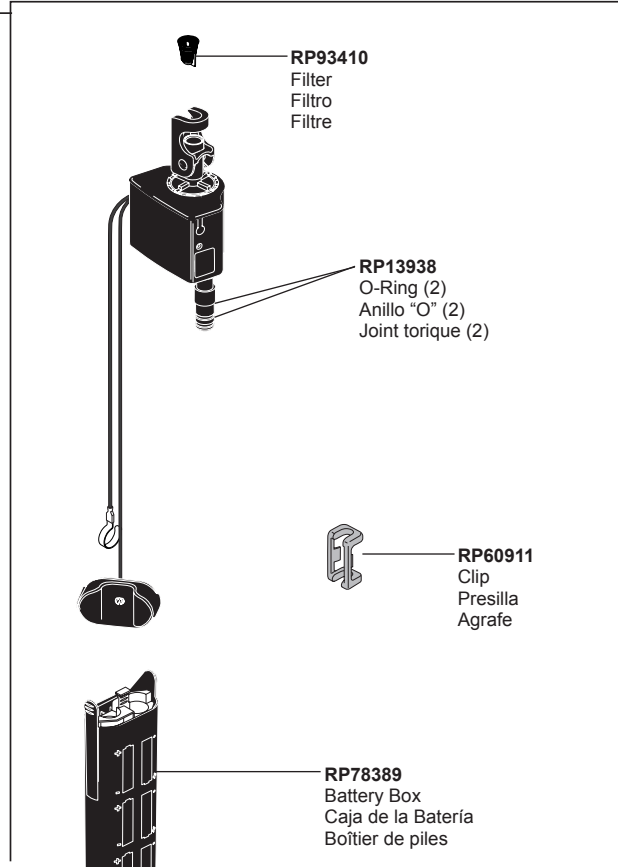

RP93410
Filter
Filtro
Filtre

RP13938
O-Ring (2)
Anillo "O" (2)
Joint torique (2)

RP60911
Clip
Presilla
Agrafe

RP78389
Battery Box
Caja de la Batería
Boîtier de piles

Other useful accessories that may be purchased separately.
Otros accesorios útiles que se pueden comprar por separado.
Autres accessoires utiles pouvant être achetés séparément.

RP63263
Adapters
3/8"-24 UNEF to 1/2"-20 UN &
3/8"-24 UNEF to 1/2"-14 NPSM
Adaptadors
3/8"-24 UNEF a 1/2"-20 UN &
3/8"-24 UNEF a 1/2"-14 NPSM
Adaptateurs
3/8 po-24 UNEF à 1/2 po-20 UN et
3/8 po-24 UNEF à 1/2 po-14 NPSM

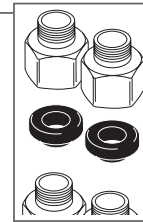

RP63264
Adapters (10) 3/8"-24 UNEF to 1/2"-20 UN
Adaptadors (10) 3/8"-24 UNEF a 1/2"-20 UN
Adaptateurs (10) 3/8 po-24 UNEF à 1/2 po-20 UN

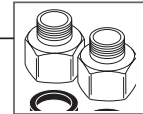

RP63265
Adapters (10) 3/8"-24 UNEF to 1/2"-14 NPSM
Adaptadors (10) 3/8"-24 UNEF a 1/2"-14 NPSM
Adaptateurs (10) 3/8 po-24 UNEF à 1/2 po-14 NPSM

