



BO480613
400 series oven
Stainless steel-backed full glass door
Width 30" (76 cm)
Controls on top

Handleless door / automatic door opening
Pyrolytic self-cleaning system
Universal heating system with 17 heating methods, with core temperature probe, rotisserie spit and baking stone operation
Automatic programs
Core temperature probe with estimation of cooking time
TFT touch display
Panel-free appliance with surface control module
Electronic temperature control from 85°F - 550°F
Net volume 110 litres

Cooking modes

Convection.
 Economy convection..
 Top + bottom heat.
 Top + 1/3 bottom heat.
 Top heat.
 1/3 top + bottom heat.
 Bottom heat.
 Convection + bottom heat.
 Convection + 1/3 bottom heat.
 Convection broiling..
 Broiling.
 Compact grill.
 Baking stone operation.
 Roaster function.
 Dough proofing.
 Defrosting.
 Keeping warm.

Operation

One touch control panel and an interactive visual display.
 Rotary knob and TFT touch display operation.
 Clear text display in 25 languages.
 Option to save 50 individual recipes (incl. core temperature probe)
 Personalization of automatic programs.
 Information key with use indicators.
 Side-opening door opens up to 180° angle.

Features

Three-point core temperature prove with automatic shut-off and estimation of cooking time.
 Automatic programs.
 Rotisserie spit.
 Baking stone outlet.
 Actual temperature display.
 Fast heating setting.
 Timer functions: cooking time, switch-off time, short-term timer, stopwatch.
 60 W halogen light on the top.
 2 x 10 W halogen light on the side.
 Enamelled side shelf supports with 5 tray levels, pyrolysis-safe.
 Home network integration for digital services (Home Connect) either via cable connection LAN (recommended) or wireless via WiFi.
 The use of the Home Connect functionality depends on the Home Connect services, which are not available in every country. For further information please check: home-connect.com.

Safety

Thermally insulated door with quadruple glazing.
 Child lock.
 Safety shut-off.

Product Features

Cooking mode
 Baking stone function, Bottom heat, Conventional heat, Defrost, Dough proving setting, Full width broil, Half width broil, Hot Air, Hot air broiling, Hot Air-Eco, Roasting function, Top heat, warming

Integrated Cleaning system

Self Clean

Interior Lights - primary cavity

3

Pull-out system

Accessory

Timer settings

Alarm, Off, On, timer

Included accessories

1 x enamel baking tray, suit. pyrolytic clean, 1 x rotary spit, 1 x grill shelf, 1 x grill tub with grid, 1 x pluggable meat probe

Bake Element Wattages primary cavity (W)

1700

Broil Element Wattages primary cavity (W)

3900

Convection Element Wattages primary cavity (W)

1900

Microwave Wattages (W)

Drawer wattage (W)

Consumption and connection features

UPC code

825225957393

Product color

Alternative colors available

Energy source

Electric

Watts (W)

5520

Current (A)

25

Volts (V)

208/220-240

Frequency (Hz)

60

Approval certificates

CSA, ETL, UL

Power Cord Length

47 1/4

Plug type

fixed connection

Required cutout size (HxWxD) (in)

26 3/16 " x 28 1/2 " x 21 11/16 "

Product packaging dimensions (HxWxD) (in)

33 7/8 x 33 7/16 x 29 15/16

Net weight (lbs)

173

Gross weight (lbs)

187

2019-12-23

Page 1

Cooled housing with temperature protection.

Cleaning

Pyrolytic self-cleaning.
 Gaggenau Clean-Enamel.
 Heated air cleaning catalyst.

Planning notes

Door hinge not reversible.
 The front of the appliance extends 1 7/8" from the cabinet front.
 Consider the overhang when planning to open drawers next to the appliance.
 When planning a corner solution, pay attention to the 90° door opening angle.
 To achieve the 21 5/8" installation depth, the connection cable needs to follow the slanted edge on the lower right hand corner of the housing.
 Plan a power outlet outside of the cut-out niche.
 The LAN port can be found at the back on the upper right side.

Rating

Total rating 5.5 kW.
 Total Amps: 25 A.
 208 / 220 - 240 V / 60 Hz.
 Connection cable 47 1/4" without plug.
 Plan for a LAN cable.

Color Variants

BO480613
Stainless steel-backed full glass door
Width 30" (76 cm)

Included accessories

1 x enamel baking tray, suit. pyrolytic clean.
 1 x rotary spit.
 1 x grill shelf.
 1 x grill tub with grid.
 1 x pluggable meat probe.

Optional accessories

BA018165
Pull-out system
BA028115
Baking tray, enameled
BA038165
Wire rack, chromium-plated
BA058115
Heating element for baking stone and cast-iron roaster
BA058133
Baking stone
BS020002
Pizza peel, additional set of 2
GN340230
Non-stick aluminum cast-iron roaster

Product Variants

BO481613
400 series oven
Stainless steel-backed full glass door
Width 30" (76 cm)
left-hinged
Controls on top

BO480613
400 series oven
Stainless steel-backed full glass door
Width 30" (76 cm)
Controls on top
2019-12-23
Page 2

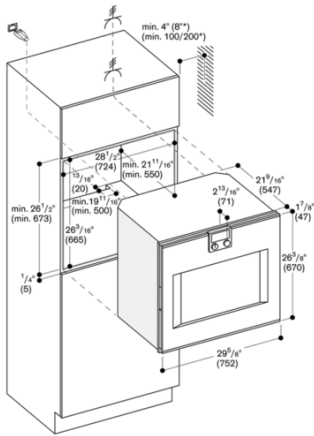

* 8" (200 mm) in conjunction with BA 018