

Features

- Fits minimum 36-inch apron sink base cabinet.
- Large/medium bowls.
- 9" (229 mm) depth provides generous workspace.
- Self-Trimming apron overlaps the cabinet face for easy installation and beautiful results.
- Smart Divide® features a low dividing barrier that increases workspace and versatility.
- Basin slopes toward drain to minimize water pooling.
- Offset drain increases workspace in the sink and storage space underneath.
- Includes cutout templates.

Material

- KOHLER® enameled cast iron.

Installation

- No faucet holes.
- Undermount farmhouse.

Recommended Products/Accessories

K-5828 Sink Rack
K-5874 Sink Rack
K-8801 Sink Strainer
K-8799 Sink Strainer
K-23726 Drain treatment
K-23725 Cast iron cleaner

Optional Products/Accessories

K-11352 Disposal Flange with Stopper
K-9000 P-Trap



Codes/Standards















ASME A112.19.1/CSA B45.2

KOHLER® Enameled Cast Iron Kitchen Sink Lifetime Limited Warranty

See website for detailed warranty information.

Available Colors/Finishes

Color tiles intended for reference only.

Color	Code	Description
	0	White
	FF	Sea Salt™
	96	Biscuit
	NY	Dune
	95	Ice™ Grey
	G9	Sandbar
	K4	Cashmere
	FT	Basalt
	58	Thunder™ Grey
	FP	Caviar
	7	Black Black™
	GRL	Grey Lavender
	DGB	Indigo Blue
	PLM	Black Plum

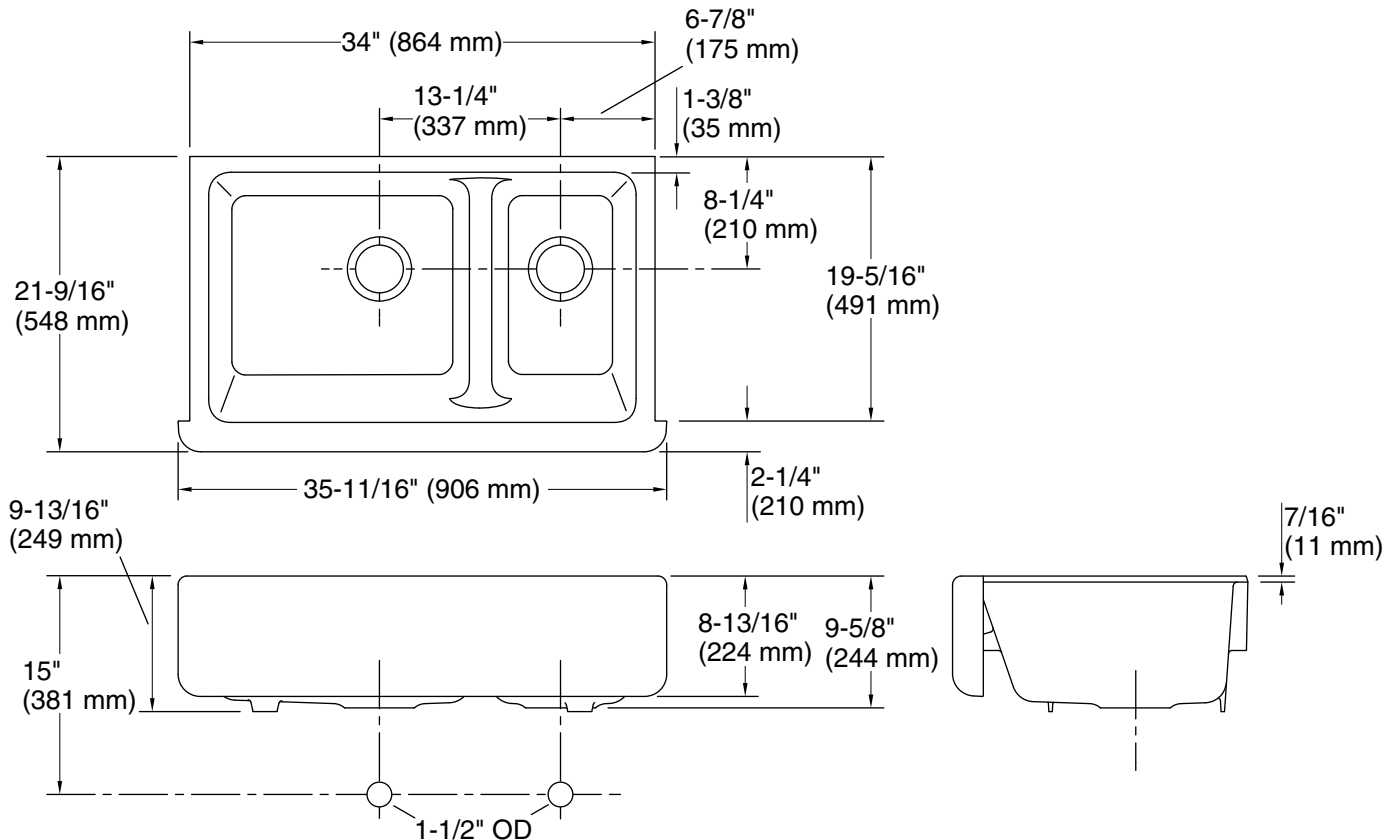

Technical Information

All product dimensions are nominal.

Bowl configuration:	Off-set Large/small
Installation:	Under-mount
Min. base cabinet width:	36" (914 mm)
Bowl area (Left):	Length: 18-13/16" (478 mm) Width: 18-1/16" (459 mm) Bowl depth: 9" (229 mm) Water depth: 9" (229 mm)
Bowl area (Right):	Length: 10-5/16" (262 mm) Width: 18-1/16" (459 mm) Bowl depth: 9" (229 mm) Water depth: 9" (229 mm)
Drain hole:	3-5/8" (92 mm)

Notes

Install this product according to the installation instructions.

NOTICE: The countertop manufacturer or cutter must use the cut-out template provided with the product, or a current one provided by Kohler Co. (call 1-800-4KOHLER). Kohler Co. is not responsible for cut-out errors when the incorrect cut-out template is used.

IMPORTANT! The distance from the top edge of the cabinet to the top of the cabinet door must be at least 9" (229 mm) to install this sink.