

PRODUCT SPECIFICATIONS

Elkay Crosstown® 16 Gauge Stainless Steel 23-1/2" x 18-1/4" x 8", Single Bowl Undermount Sink Kit with Filtered Faucet. Sink is manufactured from 16 gauge 304 Stainless Steel with a Stainless Steel finish, Rear Center drain placement, and Full spray sides and bottom with Sides and Bottom pads.

Installation Type:	Sink Kits, Undermount
Material:	304 Stainless Steel
Finish:	Stainless Steel
Gauge:	16
Sound Deadening:	Full spray sides and bottom with Sides and Bottom pads
Number of Bowls:	1
Sink Dimensions:	23-1/2" x 18-1/4" x 8"
Bowl 1 Dimensions:	21" x 15-3/4" x 8"
Drain Size:	3-1/2" (89mm)
Drain Location:	Rear Center
Minimum Cabinet Size:	27"
Mounting Hardware:	Included
Template Included:	Yes
Cutout Template #:	1000001301

Template is available for download at elkay.com. CAD software will be required to open the template.



Included with Product: LKAV7051FCR Faucet with filter included, LKDD Drain, CTXOBG1914 Bottom Grid

A Century of Tradition and Quality. For more than 100 years, Elkay has been making innovative products and providing exceptional customer care. We take pride in offering plumbing products that make life easier, inspire change and leave the world a better place.

Product Compliance: ASME A112.19.3/CSA B45.4
Faucet: ASME A112.18.1/CSA B125.1
 NSF 61
 NSF 372 (lead free)
Accessory: ASME A112.18.2/CSA B125.2
 NSF 42
 NSF 53

Installation Profile:

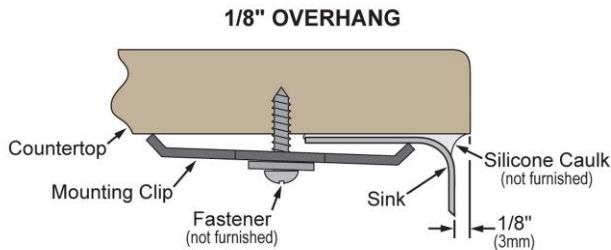



Designed to affix to the underside of any solid surface countertop.

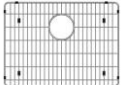

[Clean and Care Manual \(PDF\)](#)
[Installation Instructions \(PDF\) - 1000005239](#)
[Installation Instructions \(PDF\) - 1000005235](#) [drain](#)
[Installation Instructions \(PDF\) -](#)
[Warranty \(PDF\)](#)

PART: _____ QTY: _____
 PROJECT: _____
 CONTACT: _____
 DATE: _____
 NOTES: _____
 APPROVAL: _____

In keeping with our policy of continuing product improvement, Elkay reserves the right to change product specifications without notice. Please visit elkay.com for the most current version of Elkay product specification sheets. This specification describes an Elkay product with design, quality, and functional benefits to the user. When making a comparison of other producers' offerings, be certain these features are not overlooked.

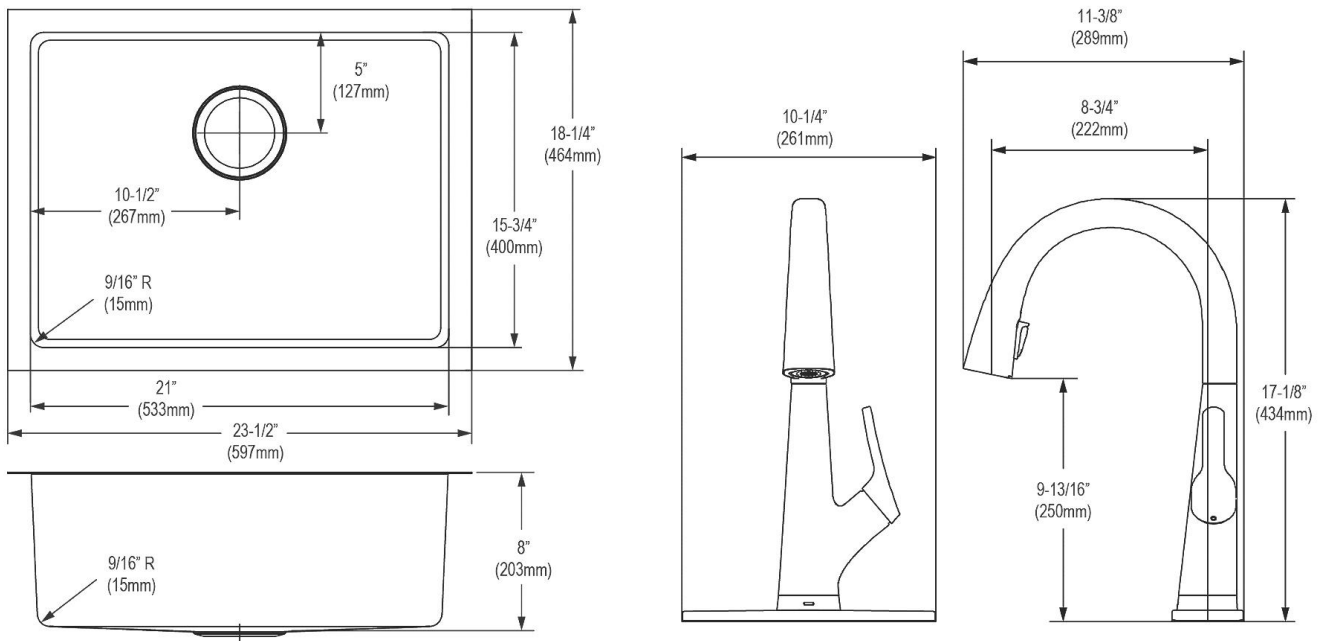
Included Accessories		
LKAV7051FCR	Elkay Avado Single Hole 2-in-1 Kitchen Faucet with Filtered Drinking Water, Chrome Spec Sheet (PDF)	
CTXOBG1914	Elkay Crosstown Stainless Steel 19-3/8" x 14-1/8" x 1-1/4" Bottom Grid Spec Sheet (PDF)	
LKDD	Elkay 3-1/2" Drain Fitting Deep Strainer Basket Spec Sheet (PDF)	



Optional Accessories		
LK35	Elkay 3-1/2" Drain Fitting Type 304 Stainless Steel Body Strainer Basket and Tailpiece Spec Sheet (PDF)	
ERF750	Elkay 750-gallon Residential Replacement Filter Spec Sheet (PDF)	

In keeping with our policy of continuing product improvement, Elkay reserves the right to change product specifications without notice. Please visit elkay.com for the most current version of Elkay product specification sheets. This specification describes an Elkay product with design, quality, and functional benefits to the user. When making a comparison of other producers' offerings, be certain these features are not overlooked.