



# S19314FSS, S19314BFSS

## Combination Drench Shower and Halo™ All Stainless Steel Eye/Face Wash

- Halo™ and SpinTec™ Deliver the Most Effective Shower and Eye/Face Washdown Coverage and Spray Pattern
- Exceeds ANSI/ISEA Z358.1 Specifications
- Industry's Only Self-Draining Design – The Aquaduct™
- Separate Supply and Waste Pipes – Meets CEN and Plumbing Requirements
- Ergonomic Hand Activation Eyewash Paddle – Easy to Reach from Any Direction
- Fully-Assembled and Factory-Tested Eye/Face Wash with Hinged Dust Covers
- Barrier Free Model Available (S19314BFSS)
- Universal Identification Sign and Inspection Tag Included
- Classified by Underwriters Laboratories Inc. to ANSI/ISEA Z358.1.
- SpinTec showerheads are covered by one or more of the following patents: 8,113,446; 7,806,348; 8,490,895; D594,089; D669,555; Reg. Comm. Des. D001079560-0001. Other patents pending.
- Halo is Covered by One or More of the Following Patents: 9,700,484; 9,314,398; D662220; D673298; D662605; D685920; D662219; and D671228. Other Patents Pending.



### Specifications

Standard and Barrier-Free Combination Drench Shower/Eye/Face Wash Units save space and fit easily into any work environment. Shower valve operates quickly by a pull rod with a triangular handle. Shower provides a superior washdown with a more even spray pattern. Halo eye/face wash, operated by an ergonomic, highly visible push handle, provides effective wash down coverage and spray pattern. Integral strainer reduces debris in the water and also prevents clogging.

**This plumbing fixture is not intended to dispense water for human consumption through drinking or for preparation of food or beverages.**

#### Pipe and Fittings

Piping to 1-1/4" NPT water supply inlet on unit. Piping to 1-1/4" NPT drain outlet. 1-1/4" piping assembly manufactured of one of the following materials:

- Type 304 corrosion resistant stainless steel

#### Ball Valve

1" shower ball valve and 1/2" stay-open eye and eye/face wash valve manufactured of the following material and supplied with Type 304 stainless steel pull rod and handle:

- Type 316 stainless steel ball valve

#### SpinTec™ Showerhead

High performance Type 304 corrosion-resistant stainless steel showerhead measures 1 1/2" (38mm) in diameter. SpinTec drench showerhead features integral 22 GPM (83.3 L) flow control (exceeds minimum water flow of 20 GPM (75.7L) at 30 PSI (2.0 bar)), conserving water and helping to accurately size your tepid water system.

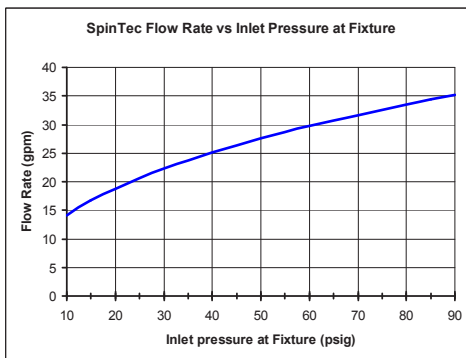

#### Eye/Face Wash

The Halo eye/face wash system offers a high performance rinsing platform that provides rapid relief to an individual's eyes and face that have been injured by chemicals or particulate. This system provides the most complete face wash available in the market. The eye/face wash includes an integral 5.1 GPM (19.2 L) flow control, providing water at a safe velocity while maintaining its effectiveness (exceeds minimum water flow of 3.0 GPM (11.4 L) at 30 PSI (2.0 bar)). The eye/face wash is protected by flip open dust covers that open when the product is activated by type 316 stainless steel push handle. Safe, steady water flow under varying water supply conditions from 30–90 PSI (2.0-6.1 bar) is assured by integral flow control in the sprayhead assembly. Sprayheads are made from durable 304 stainless steel with electro-polished finish.

#### Bowl

Bowl is constructed of Type 304 corrosion-resistant stainless steel.

**For information on all available S19314 models, please see tech data document Bradley\_SafetyCombi\_S19314Series.**

| Model                               | Description   |
|-------------------------------------|---|
| <input type="checkbox"/> S19314BFSS | Halo stainless steel eye/face wash and showerhead, barrier free |
| <input type="checkbox"/> S19314FSS  | Halo stainless steel eye/face wash and showerhead               |

### Tepid Water Options

[Navigator S19-2150 EFX20](#)  
[Emergency Thermostatic Mixing Valve](#)

[Keltech SNA-Series](#)  
[Tankless Water Heater](#)

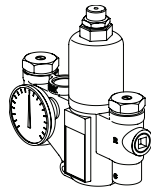
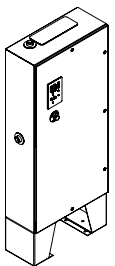
Satisfies ANSI/ISEA Z358.1 tepid water requirements.



# S19314FSS, S19314BFSS

## Combination Drench Shower and Halo™ All Stainless Steel Eye/Face Wash

### S19314 shown with Stainless Steel Bowl and Showerhead

Drawing depicts Eyewash. Eye/Face Wash dimensions are the same.

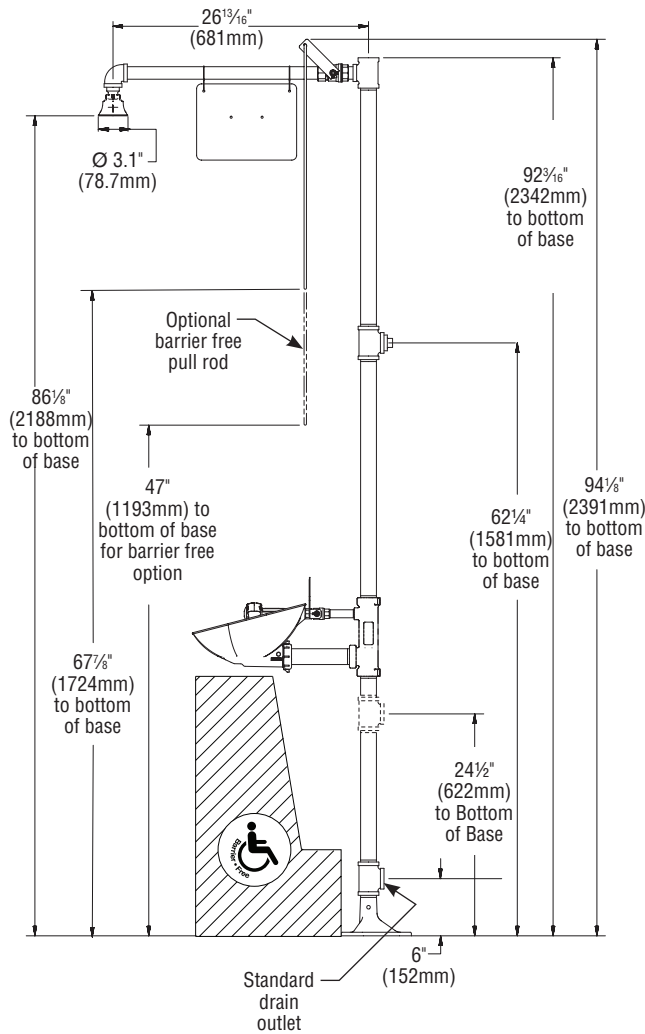

Type 304 Showerhead

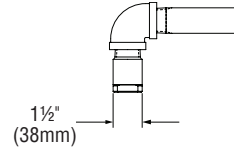

Eye/Face Wash Bowl

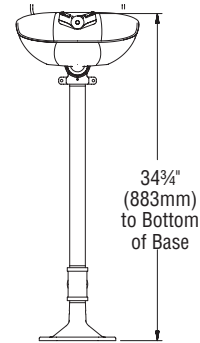
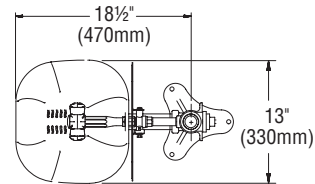

All dimensions assume standard thread engagement. Variations in manufacturing allow for  $\pm \frac{1}{8}$ " (3mm) per threaded joint. To find the tolerance of a dimension, add the number of thread joints across the length of the dimension and multiply it by  $\frac{1}{8}$ " (3mm).