

DIVERTER AND BACKWATER VALVES

Diverter Valve

Here's the simplest, strongest, and most economical diverter valve ever invented for septic tank leach fields. It is made of tough molded plastic that will not shatter, bend, rust or corrode. It is lighter in weight, easier to handle and less expensive to ship.

Functional

The diverter valve stem flow may be controlled to individual or multiple fields (up to three) in any combination. With a three-way valve stem, flow may be diverted to any two outlets. To allow flow through all outlets, the valve stem may be removed from the assembly.

Easy To Install

Connect 4" plastic sewer and drain pipe to inlets and outlets on the four way distribution box. (Unwanted outlets may be sealed by installing caps). The Diverter shield which houses the diverter stem may be cut to desired length.

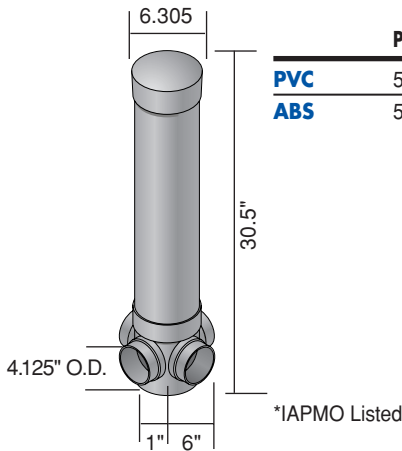

	Part No.	Description	Color	Pkg. Qty.	Wt. Ea. (lbs.)	Product Class
PVC	575P	4" PVC Diverter Valve	White	4	9.50	35PV
ABS	575	4" ABS Diverter Valve	Black	4	7.50	35AB

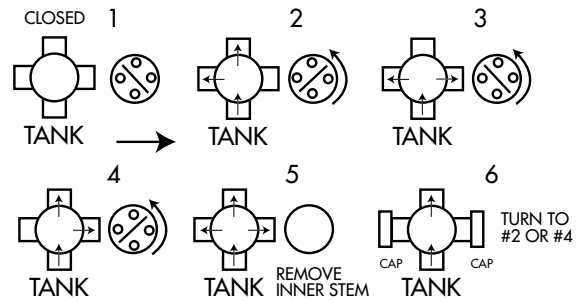

Gravity Backwater Valve

The NDS gravity flow Backwater Valve is designed to protect low areas or basements from the backflow of waste from street sewers. It is available in 2", 3", 4" and 6" sizes PVC material. It is a cost effective and a chemically resistant alternative to cast iron valves.

Backwater Valve

The quick action flapper allows unrestricted uni-directional flow. Elastomeric gasket in the flapper ensures a watertight seal. Flapper can be easily removed and replaced if required.

Threaded access cap is designed for hand tightening. Access cap neoprene gasket provides a positive seal. Valve hub outlets fit 2", 3", 4", or 6" DWV pipe and may be adapted to 2", 3", 4", or 6" sewer and drain pipe with NDS DWV to Sewer & Drain Adapters.

Lightweight, easy to install. Horizontal installation required, with arrows on top of the valve hub pointing in the direction of the flow of water. Access riser with cover offers a simple, economical access to the valve for inspection and maintenance. The riser may be cut to the desired length.

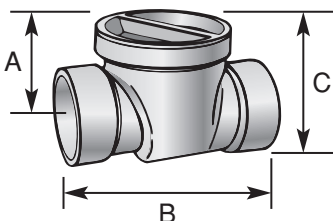

Item Number	A	B	C	Riser Height	Riser Dia.
275P, 275	2.18	5.03	3.53	16	4
275PR	2.18	5.03	3.53	16	4
375P, 375	3.51	7.56	6.10	16	6
375PR, 375R	3.51	7.56	6.10	16	6
475P, 475	4.47	11.18	7.18	16	8
475PR, 475R	4.47	11.18	7.18	16	8
675P, 675	5.50	15.25	9.90	16	10



Approvals applicable to valve only.



Note: All dimensions are nominal. All weights are for shipping purposes only. Availability is subject to change.

DIVERTER AND BACKWATER VALVES

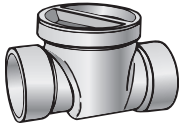
Backwater Valve

	Part No.	Description	Color	Pkg. Qty.	Wt. Ea. (lbs.)	Product Class
	PVC					
	275P	2" PVC Backwater Valve	White	8	1	35PV
	275PR	2" PVC Backwater Valve with Riser and Cover	White	1	5.00	35PV
	375P	3" PVC Backwater Valve	White	6	2.33	35PV
	375PR	3" PVC Backwater Valve with Riser and Cover	White	1	5.00	35PV
	475P	4" PVC Backwater Valve	White	6	4.33	35PV
	475PR	4" PVC Backwater Valve with Riser	White	1	8.00	35PV
	675P	6" PVC Backwater Valve	White	1	9.00	35PV
	ABS					
	275	2" ABS Backwater Valve	Black	8	1	35AB
375	3" ABS Backwater Valve	Black	6	1.83	35AB	
375R	3" ABS Backwater Valve with Riser and Cover	Black	1	4.00	35AB	
475	4" ABS Backwater Valve	Black	6	3.33	35AB	
475R	4" ABS Backwater Valve with Riser and Cover	Black	1	7.00	35AB	
675	6" ABS Backwater Valve and Cover	Black	24	7.00	35AB	

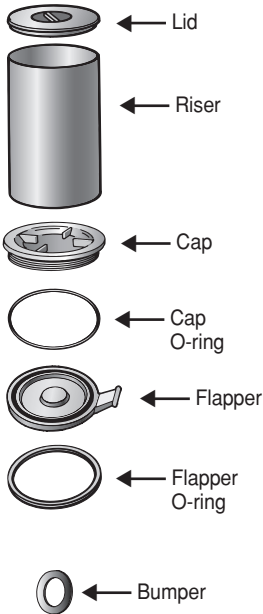
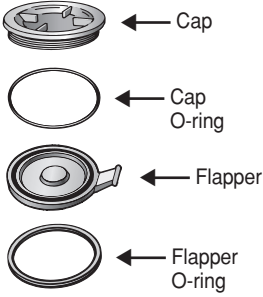
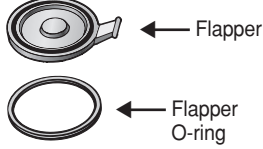
PVC Backwater Valve Components

	Part No.	Description	Color	Carton Qty.	Product Class
	8051-020-040	2" Lid	White	20	80CS
	822-040-16	2" Riser	White	4	80CS
	1530202	2" Cap	White	10	80CS
	880-237	2" Cap O'Ring	Black	10	80CS
	1530203	2" Flapper	White	10	80CS
	880-136	2" Flapper O'Ring	Black	10	80CS
	1530204	2" Back Water Valve Pipe Extension Collar	White	10	80CS
	8051-030-060	3" Lid	White	25	80CS
	822-060-16	3" Riser	White	2	80CS
	1530302	3" Cap	White	10	80CS
	880-253	3" Cap O'Ring	Black	10	80CS
	1530303	3" Flapper	White	10	80CS
	880-234	3" Flapper O'Ring	Black	10	80CS
	1530304	3" Back Water Valve Pipe Extension Collar	White	10	80CS
	8051-040-080	4" Lid	White	20	80CS
	822-080-16	4" Riser	White	1	80CS
	1530402	4" Cap	White	10	80CS
	880-364	4" Cap O'Ring	Black	10	80CS
	1530403	4" Flapper	White	10	80CS
	880-243	4" Flapper O'Ring	Black	10	80CS
	1530404	4" Back Water Valve Pipe Extension Collar	White	10	80CS
	8051-060-100	6" Lid	White	15	80CS
	1530602	6" Cap	White	2	80CS
	880-271	6" Cap O'Ring	Black	2	80CS
	1530603	6" Flapper	White	5	80CS
	880-259	6" Flapper O'Ring	Black	5	80CS
	880-202	Bumper (fits all sizes of valves)	Black	1	80CS
	1530405	4" BWV Sewer Adapt Flange	White	1	80CS
	1530605	6" BWV Sewer Adapt Flange	White	1	80CS
					

Backwater Valve Box

	Part No.	Description	Color	Pkg. Qty.	Wt. Ea. (lbs.)	Product Class
	1219	12"x12" Backwater Valve Box	Black	4	5.75	10ND
	1220	12"x12" Valve Box Cover	Black	8	2.00	10ND

Note: All dimensions are nominal. All weights are for shipping purposes only. Availability is subject to change.