



Hart & Cooley[®]
install confidence

Type B Gas Vent Systems

Edition 4



Hart & Cooley
install confidence

Hart & Cooley, Inc. 800.433.6341 *p*
5030 Corporate Exchange Blvd. SE 616.656.8200 *p*
Grand Rapids, MI 49512 800.223.8461 *f*
info@hartcool.com 616.656.6399 *f*
www.hartandcooley.com

Order information:

To order Hart & Cooley products,
please contact any authorized
Hart & Cooley distributor or
call 800.433.6341.

When you purchase Hart & Cooley products, you
also receive the full support of Hart & Cooley
technical and customer service.

Technical and customer service:

800.433.6341 *toll-free*
616.656.8200 *phone*
800.223.8461 *toll-free fax*
616.656.6399 *fax*

Internet address:

<http://www.hartandcooley.com>

Install confidence with these other quality

Hart & Cooley products available:

- Grilles, Registers & Diffusers
- Type B Gas Vent Systems
- Special Gas Vent
- Model TLC All-Fuel Chimney
- Duct System Components
- Flexible Duct Systems

TYPE B GAS VENT SYSTEMS

CONSTRUCTION FEATURES2

TYPE B ROUND GAS VENT PIPE & FITTINGS

RP	Round Pipe 3" through 12"3
RP	Round Pipe 14" through 30"3
RPA/R18A	Adjustable Length Pipe4
REA90	90° Adjustable Elbow4
REA60	60°/45° Adjustable Elbow4
RE45	45° Elbow4
REA45	45° Adjustable Elbow4
RT	Tee5
RTC	Tee Cap5
RYF	Wye5
RDH	Draft Hood Connector5
RHW	Cap 3" through 6"6
RM	Cap 7" through 12"6
C	Metal Cap 14" through 30"6
RN	Increaser6
CU	Universal Cap 14" through 30"6
RIX	Universal Increaser/Adapter6
RIX	Increaser7
RA	Male Adapter7
RAA	Male Adapter7
RRA	Female Adapter7
RF	Adjustable Roof Flashing Flat to 6/128
RFA	Adjustable Roof Flashing 6/12 to 12/128
RTF	Tall Cone Roof Flashing8
RS	Storm Collar 3" through 6"9
RS	Adjustable Storm Collar 7" through 12"9
SC	Adjustable Storm Collar 14" through 30"9
RGS	Gripper Support 3" through 6"9
RSA	Support Assembly 3" through 12"10
SP	Support Plate10
RPC	Pipe Collar 3" through 8"10
RWT	Wall Thimble11

RWB	Wall Bracket11	RFS	Firestop Spacer11
SFC	Single-Wall Flexible Gas Vent Connector12	DFC	Double-Wall Flexible Gas Vent Segment12

TYPE B OVAL GAS VENT PIPE & FITTINGS

OP	Oval Pipe13
OPA	Adjustable Oval Pipe13
OES45	Elbow - Standard13
OEF45	Elbow - Flat14
OT	Standard Oval Tee14
OBC	Tee Support14
OTC	Oval Tee Cap14
OAR	Adapter (oval to round)15
OARA	Oval-to-Round Adapter15
RAO	Round-to-Oval Adapter15
OCP	Plate Spacers15
OBPWS	Hold-Down Plate15
OFS	Firestop Spacers16
OC	4" Oval Cap16
ECW	5" Cap16
OF	Oval Flashing16
OSC	Oval Storm Collar16
Typical Type B Gas Vent Installations17	

GAS APPLIANCE CHIMNEY LINER SYSTEMS

RLK	Basic Kit18
RLKE	Extension Kit18
RLA	Female B-Vent Adapter18
RLPC	Pulling Cone18
RHW	Metal Cap (High Wind)19
RM	Metal Cap19
RLTF	Termination Fitting19
RLF	Flashing19
RLM	Mortar Sleeve19
RLS	Single-Wall Collar19

Type B Gas Vent Systems Give You These Important Advantages

Safety of the Hart & Cooley® system is assured by the double-wall, air-insulated design and locking joints. Properly installed, the vent cannot come apart through vibration, and offers protection against vent failure or fire hazard. Type B Gas Vent is designed for negative pressure applications and flue gas temperatures not exceeding 550° F for Category I appliances.

Durability is the result of high-quality materials and workmanship, with galvanized outer pipe and aluminum inner pipe providing protection against corrosion and external damage.

Simple installation is achieved with a complete line of adjustable fittings and various lengths of pipe. Curled ends lock together for stability and easy assembly. A full set of installation instructions are supplied with all caps and supports.

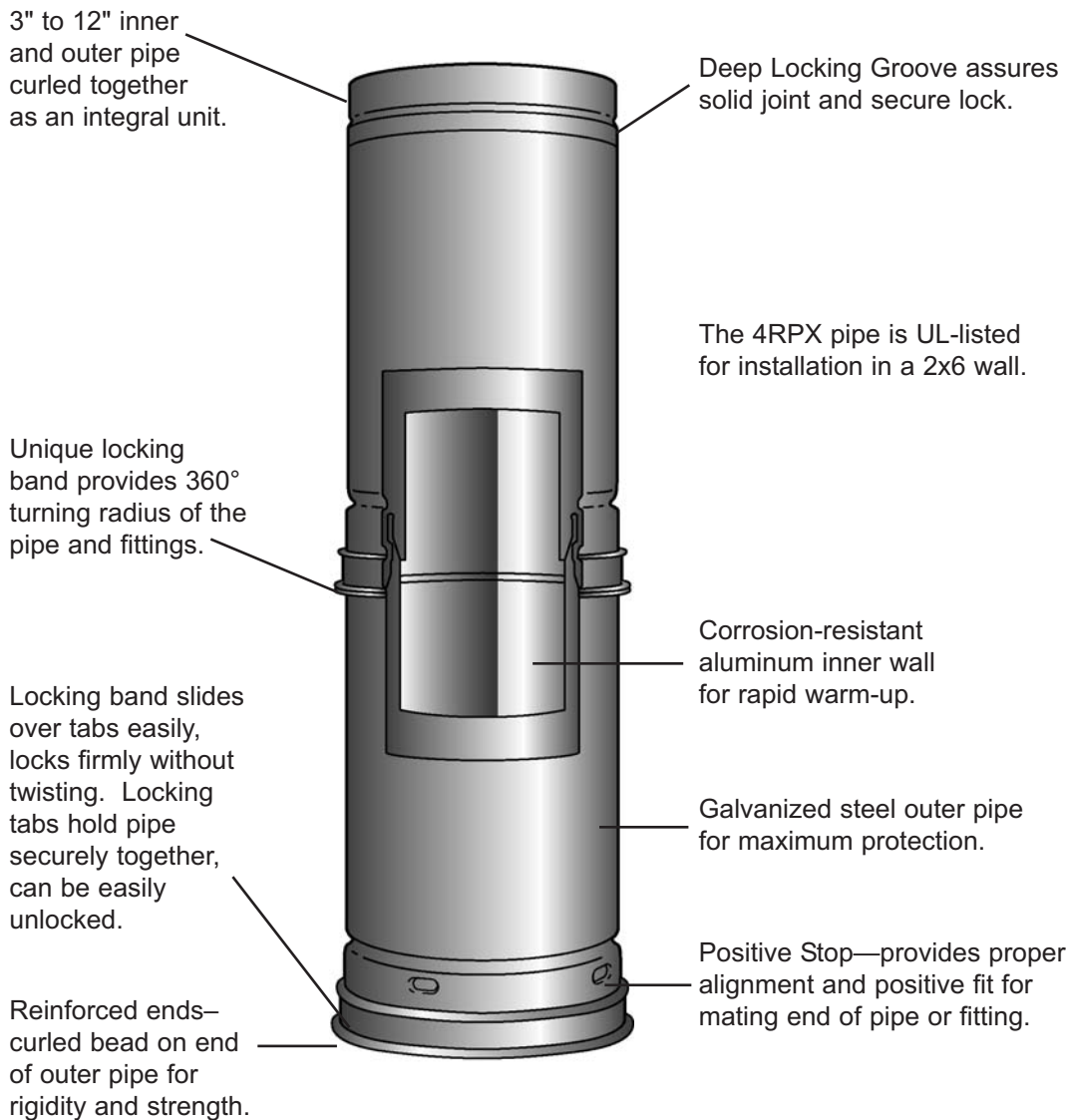

HART & COOLEY® B-VENT
complies with the latest
Underwriters Laboratories Standard No. 441

This Product is Listed by
UNDERWRITERS LABORATORIES INC.
and Bears the Mark:





RP* Round Pipe
3" through 12"

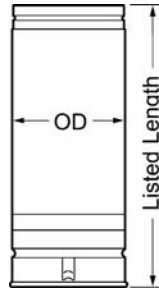

Lock-Ring Style

RP* Round Pipe
14" through 30"

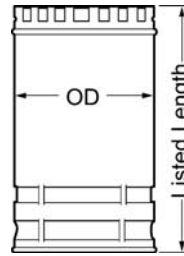

Snap-Lock Style

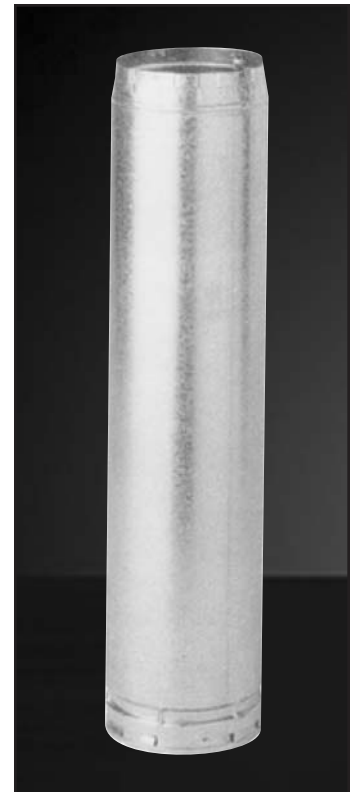

Size	Model Number	Listed Length
3"	3RP5	5'
	3RP4	4'
	3RP3	3'
	3RP24	24"
	3RP18	18"
	3RP12	12"
	3RP6	6"

Size	Model Number	Listed Length
7"	7RP5	5'
	7RP4	4'
	7RP3	3'
	7RP24	24"
	7RP18	18"
	7RP12	12"

Size	Model Number	Listed Length
20"	20R3	3'
	20R24	24"
	20R18	18"
	20R12	12"

Size	Model Number	Listed Length
4"	4RPX5	5'
	4RPX4	4'
	4RPX3	3'
	4RPX24	24"
	4RPX18	18"
	4RPX12	12"
	4RPX6	6"

Size	Model Number	Listed Length
8"	8RP5	5'
	8RP4	4'
	8RP3	3'
	8RP24	24"
	8RP18	18"
	8RP12	12"

Size	Model Number	Listed Length
22"	22R3	3'
	22R24	24"
	22R12	12"

Size	Model Number	Listed Length
5"	5RP5	5'
	5RP4	4'
	5RP3	3'
	5RP24	24"
	5RP18	18"
	5RP12	12"

Size	Model Number	Listed Length
10"	10RP3	3'
	10RP24	24"
	10RP18	18"

Size	Model Number	Listed Length
24"	24R3	3'
	24R24	24"
	24R18	18"
	24R12	12"

Size	Model Number	Listed Length
6"	6RP5	5'
	6RP4	4'
	6RP3	3'
	6RP24	24"
	6RP18	18"
	6RP12	12"

Size	Model Number	Listed Length
12"	12RP3	3'
	12RP24	24"
	12RP18	18"

Size	Model Number	Listed Length
26"	26R3	3'
	26R24	24"
	26R18	18"
	26R12	12"

Size	Model Number	Listed Length
14"	14R3	3'
	14R24	24"
	14R12	12"

Size	Model Number	Listed Length
28"	28R3	3'
	28R24	24"
	28R18	18"
	28R12	12"

Size	Model Number	Listed Length
16"	16R3	3'
	16R24	24"
	16R18	18"
	16R12	12"

Size	Model Number	Listed Length
30"	30R3	3'
	30R24	24"
	30R12	12"

Size	Model Number	Listed Length
18"	18R3	3'
	18R24	24"
	18R18	18"
	18R12	12"

- 3" to 12" pipe and fitting couplers overlap 1³/₈" when joined together; therefore, assembled length is 1³/₈" less than listed length.
- 14" to 30" sizes overlap 1" when joined together; therefore assembled length is 1" less than listed length.
- The allowable minimum clearance to combustibles is 1", except for 4RPX on which clearance is provided by locking band on pipe only when installed in a 2 x 6 stud wall.
- Outside Diameter (OD)
 Sizes 3" through 6" is size plus 1/2"
 Sizes 7" through 30" is size plus 1"

Type B Round Gas Vent Pipe & Fittings



RPA*/R18A* Adjustable Length Pipe

Model Number	Size	Listed Length†
3RPA	3"	12"
4RPA	4"	12"
5RPA	5"	12"
6RPA	6"	12"
7RPA	7"	18"
8RPA	8"	18"
10RPA	10"	18"
12RPA	12"	18"
14R18A	14"	18"
16R18A	16"	18"
18R18A	18"	18"
20R18A	20"	18"
22R18A	22"	18"
24R18A	24"	18"
26R18A	26"	18"
28R18A	28"	18"
30R18A	30"	18"

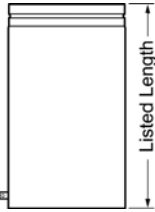

†Overlap: Minimum 1½"
 - Maximum overlap on a 12" length is 10".
 - Maximum overlap on a 18" length is 16".



REA90* 90° Adjustable Elbow

Model Number	Size	Dim. A	Dim. B	Dim. C
3REA90	3"	5½"	3¾"	7¼"
4REA90	4"	6"	4¼"	8¼"
5REA90	5"	6½"	4¾"	9¼"
6REA90	6"	7"	5¼"	10¼"
7REA90	7"	7¾"	6"	11¾"
8REA90	8"	8¼"	6½"	12¾"

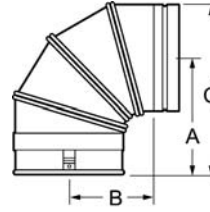

REA60* 60°/45° Adjustable Elbow

Model Number	Size	Dim. A I.D.	Dim. B O.D.	Dim. C	Dim. D
3REA60	3"	3"	3½"	1⅞"	5¼"
4REA60	4"	4"	4½"	2⅞"	5½"
5REA60	5"	5"	5½"	2¼"	6"
6REA60	6"	6"	6½"	2⅝"	6⅜"

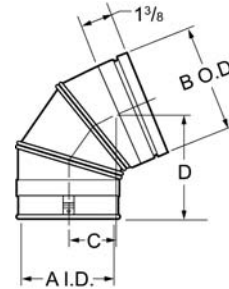

R45* 45° Elbow

- 14" elbow is adjustable.
- 16" through 30" elbows are fixed.

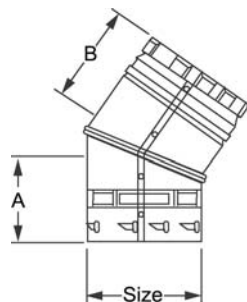

Model Number	Size	Dim. A	Dim. B
14R45	14"	6⅝"	6½"
16R45	16"	7"	7"
18R45	18"	7⅞"	7½"
20R45	20"	8½"	8⅝"
22R45	22"	8"	7⅝"
24R45	24"	8⅝"	8⅝"
26R45	26"	9"	9"
28R45	28"	9½"	9½"
30R45	30"	10"	10"



REA45* 45° Adjustable Elbow

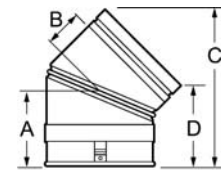

Model Number	Size	Dim. A	Dim. B	Dim. C	Dim. D
7REA45	7"	4⅜"	2⅝"	10⅜"	4¾"
8REA45	8"	4⅝"	2⅞"	11⅞"	4¾"
10REA45	10"	5"	3¼"	12¾"	4¾"
12REA45	12"	5½"	3¾"	13¾"	4¾"

*Denotes UL listing



RT* Tee

Model Number	Size	Dim. A	Dim. B	Dim. C	Dim. D
3RT3	3" x 3" x 3"	7 ¹ / ₂ "	4 ¹ / ₂ "	6 ¹ / ₄ "	4 ¹ / ₂ "
4RT4	4" x 4" x 4"	8 ¹ / ₂ "	5"	7 ¹ / ₄ "	5"
5RT5	5" x 5" x 5"	9 ¹ / ₂ "	5 ¹ / ₂ "	8 ¹ / ₄ "	5 ¹ / ₂ "
5RT4	5" x 5" x 4"	9 ¹ / ₂ "	5 ¹ / ₂ "	8 ¹ / ₄ "	5 ¹ / ₂ "
5RT3	5" x 5" x 3"	9 ¹ / ₂ "	5 ¹ / ₂ "	8 ¹ / ₄ "	5 ¹ / ₂ "
6RT6	6" x 6" x 6"	10 ¹ / ₂ "	6"	9 ¹ / ₄ "	6"
6RT4	6" x 6" x 4"	10 ¹ / ₂ "	6"	9 ¹ / ₄ "	6"
6RT3	6" x 6" x 3"	10 ¹ / ₂ "	6"	9 ¹ / ₄ "	6"
7RT7	7" x 7" x 7"	11 ¹ / ₂ "	6 ¹ / ₂ "	10 ³ / ₄ "	6 ³ / ₄ "
8RT8	8" x 8" x 8"	12 ¹ / ₂ "	7"	11 ³ / ₄ "	7 ¹ / ₄ "
10RT10	10" x 10" x 10"	14 ¹ / ₂ "	8"	13 ³ / ₄ "	8 ¹ / ₄ "
12RT12	12" x 12" x 12"	16 ¹ / ₂ "	9"	15 ³ / ₄ "	9 ¹ / ₄ "
14RT	14" x 14" x 14"	24"	11 ³ / ₄ "		
16RT	16" x 16" x 16"	26"	13"		
18RT	18" x 18" x 18"	28 ¹ / ₂ "	14 ¹ / ₄ "		
20RT	20" x 20" x 20"	30"	15 ¹ / ₂ "		
22RT	22" x 22" x 22"	33"	16 ³ / ₄ "		
24RT	24" x 24" x 24"	36"	18"		
26RT	26" x 26" x 26"	38"	19"		
28RT	28" x 28" x 28"	40"	20"		
30RT	30" x 30" x 30"	42"	21"		

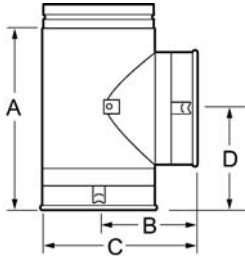

RTC Tee Cap

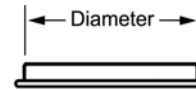

Model Number	Diameter Size
3RTC	3"
4RTC	4"
5RTC	5"
6RTC	6"
7RTC	7"
8RTC	8"
10RTC	10"
12RTC	12"
14RTCP	14"
16RTCP	16"
18RTCP	18"
20RTCP	20"
22RTCP	22"
24RTCP	24"
26RTCP	26"
28RTCP	28"
30RTCP	30"



RYF* Wye

Model Number	Size X / Y / Z
4RYF33	4" / 3" / 3"
4RYF44	4" / 4" / 4"
4RYF43	4" / 4" / 3"
5RYF53	5" / 5" / 3"
5RYF54	5" / 5" / 4"
5RYF43	5" / 4" / 3"
5RYF44	5" / 4" / 4"
6RYF54	6" / 5" / 4"
6RYF53	6" / 5" / 3"
6RYF43	6" / 4" / 3"
6RYF44	6" / 4" / 4"
6RYF63	6" / 6" / 3"
6RYF64	6" / 6" / 4"

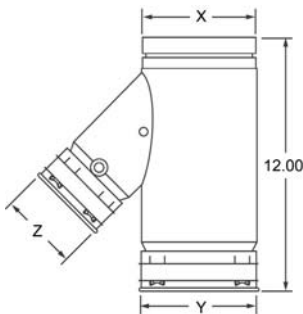

RDH* Draft Hood Connector

Model Number	Size	Dim. A	Dim. B
3RDH	3"	4 ¹ / ₂ "	6"
4RDH	4"	4 ¹ / ₂ "	6"
5RDH	5"	4 ¹ / ₂ "	6"
6RDH	6"	4 ¹ / ₂ "	6"
7RDH	7"	7"	8 ¹ / ₂ "
8RDH	8"	7"	8 ¹ / ₂ "
10RDH	10"	7"	8 ¹ / ₂ "
12RDH	12"	7"	8 ¹ / ₂ "

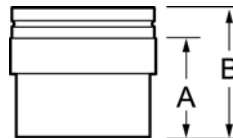

*Denotes UL listing

Type B Round Gas Vent Pipe & Fittings

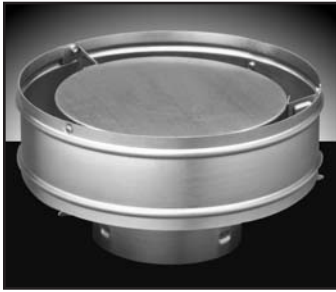

RHW* Cap 3" through 6"

- Exceptional performance in windy conditions.
- Designed to resist nesting birds.

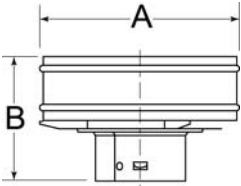

Model Number	Size	Dim A.	Dim. B
3RHW	3"	8 ¹ / ₄ "	4 ¹ / ₂ "
4RHW	4"	9 ¹ / ₄ "	4 ⁷ / ₈ "
5RHW	5"	10 ¹ / ₂ "	5 ¹ / ₄ "
6RHW	6"	11 ¹ / ₄ "	5 ⁵ / ₈ "



RM* Cap 7" through 12"

- Barriers provided in cap opening spaced less than 1" are designed to resist entry of birds.

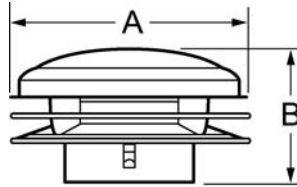

Model Number	Size	Dim A.	Dim. B
7RM	7"	14 ¹ / ₈ "	6 ⁷ / ₈ "
8RM	8"	15 ¹ / ₈ "	7"
10RM	10"	19 ¹ / ₈ "	9"
12RM	12"	21 ¹ / ₈ "	10 ¹ / ₂ "



C* Metal Cap 14" through 30"

- Barriers provided in cap opening spaced less than 1" are designed to resist entry of birds.
- Snap-locks onto pipe.

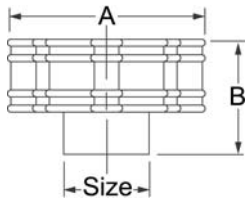

Model Number	Size	Dim A.	Dim. B
14C	14"	22"	11"
16C	16"	25"	12"
18C	18"	28 ¹ / ₄ "	13 ¹ / ₂ "
20C	20"	31 ¹ / ₂ "	15"
22C	22"	34 ¹ / ₂ "	16 ¹ / ₂ "
24C	24"	37 ³ / ₄ "	18"
26C	26"	42"	19 ¹ / ₂ "
28C	28"	44"	21"
30C	30"	48"	22 ¹ / ₂ "



RN* Increaser

Model Number	Size	Dim A.	Dim. B
3RN4	3" to 4"	3 ³ / ₄ "	5 ¹ / ₄ "
3RN5	3" to 5"	3 ³ / ₄ "	5 ¹ / ₄ "
3RN6	3" to 6"	3 ³ / ₄ "	5 ¹ / ₄ "
3RN7	3" to 7"	3 ³ / ₄ "	5 ¹ / ₄ "
4RN5	4" to 5"	3 ³ / ₄ "	5 ¹ / ₄ "
4RN6	4" to 6"	3 ³ / ₄ "	5 ¹ / ₄ "
4RN7	4" to 7"	3 ³ / ₄ "	5 ¹ / ₄ "
5RN6	5" to 6"	3 ³ / ₄ "	5 ¹ / ₄ "
6RN7	6" to 7"	3 ³ / ₄ "	5 ¹ / ₄ "
6RN8	6" to 8"	3 ³ / ₄ "	5 ¹ / ₄ "
7RN8	7" to 8"	3 ⁷ / ₈ "	5 ³ / ₈ "
8RN10	8" to 10"	3 ⁷ / ₈ "	5 ³ / ₈ "
8RN12	8" to 12"	3 ⁷ / ₈ "	5 ³ / ₈ "
10RN12	10" to 12"	3 ⁷ / ₈ "	5 ³ / ₈ "

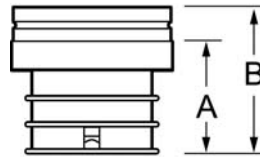

CU* Universal Cap 14" through 30"

- Barriers provided in cap opening spaced less than 1" are designed to resist entry of birds.
- Slips into most B Vent.

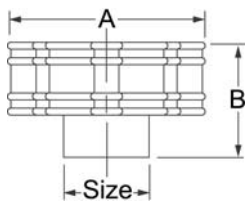

Model Number	Size	Dim A.	Dim. B
14CU	14"	22"	11"
16CU	16"	25"	12"
18CU	18"	28 ¹ / ₄ "	13 ¹ / ₂ "
20CU	20"	31 ¹ / ₂ "	15"
22CU	22"	34 ¹ / ₂ "	16 ¹ / ₂ "
24CU	24"	37 ³ / ₄ "	18"
26CU	26"	42"	19 ¹ / ₂ "
28CU	28"	44"	21"
30CU	30"	48"	22 ¹ / ₂ "



RIX* Universal Increaser/Adapter

- Adapts and increases from locking ring style, small-diameter vent pipe to new snap-lock large-diameter vent pipe.

Model Number	Diameter Size
8RIX14U	8" to 14"
10RIX14U	10" to 14"
10RIX16U	10" to 16"
10RIX18U	10" to 18"
12RIX14U	12" to 14"
12RIX16U	12" to 16"
12RIX18U	12" to 18"
12RIX20U	12" to 20"

*Denotes UL listing



RIX* Increaser

Model Number	Diameter Size
14RIX16	14" to 16"
14RIX18	14" to 18"
16RIX18	16" to 18"
14RIX20	14" to 20"
16RIX20	16" to 20"
18RIX20	18" to 20"
14RIX22	14" to 22"
16RIX22	16" to 22"
18RIX22	18" to 22"
20RIX22	20" to 22"
16RIX24	16" to 24"
18RIX24	18" to 24"
20RIX24	20" to 24"

Model Number	Diameter Size
22RIX24	22" to 24"
18RIX26	18" to 26"
20RIX26	20" to 26"
22RIX26	22" to 26"
24RIX26	24" to 26"
20RIX28	20" to 28"
22RIX28	22" to 28"
24RIX28	24" to 28"
26RIX28	26" to 28"
22RIX30	22" to 30"
24RIX30	24" to 30"
26RIX30	26" to 30"
28RIX30	28" to 30"



RA* Male Adapter

- Adapts other brands of B vent to Hart & Cooley vent (theirs to ours).

Model Number	Size	I.D. A	Dim. B
3RA	3"	3 ⁹ / ₁₆ "	6"
4RA	4"	4 ⁹ / ₁₆ "	6"
5RA	5"	5 ⁹ / ₁₆ "	6"
6RA	6"	6 ⁹ / ₁₆ "	6"
7RA	7"	7 ⁹ / ₁₆ "	17 ³ / ₄ "
8RA	8"	8 ⁹ / ₁₆ "	17 ³ / ₄ "

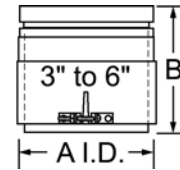
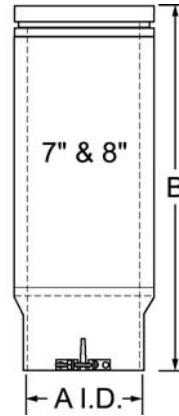

RAA* Male Adapter

- Adapts other brands of B vent to Hart & Cooley vent (theirs to ours).

Model Number	Size	I.D. A	Dim. B
3RAA	3"	3 ¹¹ / ₁₆ "	6"
4RAA	4"	4 ¹¹ / ₁₆ "	6"
5RAA	5"	5 ¹¹ / ₁₆ "	6"
6RAA	6"	6 ¹¹ / ₁₆ "	6"
7RAA	7"	7 ¹¹ / ₁₆ "	8 ¹ / ₂ "
8RAA	8"	8 ¹¹ / ₁₆ "	8 ¹ / ₂ "

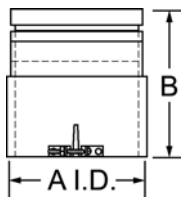

Competitive Manufacturer	Pipe Diameter	Airspace	Adapter Male	Model Female
Metalbestos	3" - 6"	1/4"	RA or RPA†	RRA
	7" - 8"	1/4"	RA	-
Metal Fab	3" - 6"	1/4"	RA or RPA†	RRA
	7" - 8"	1/2"	RPA	-
AmeriVent	3" - 6"	1/4"	RA or RPA†	RRA
	7" - 8"	1/2"	RPA	-
Air-Jet	3" - 6"	3/8"	RAA	-
	7" - 8"	3/8"	RAA	-
DuraVent	3" - 6"	5/16"	RAA	RRA
	7" - 8"	5/16"	RAA	-

†See page 4 on RPA 3" through 24" adjustable length.



RRA* Female Adapter

- Adapts Hart & Cooley vent to other brands of B vent (ours to theirs).

Model Number	Size	I.D. A	Dim. B
3RRA	3"	3 ³ / ₄ "	6"
4RRA	4"	4 ³ / ₄ "	6"
5RRA	5"	5 ³ / ₄ "	6"
6RRA	6"	6 ³ / ₄ "	6"

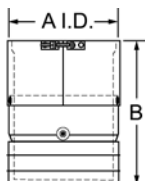

*Denotes UL listing

Type B Round Gas Vent Pipe & Fittings

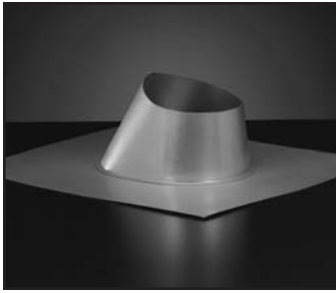

RF Adjustable Roof Flashing Flat to 6/12

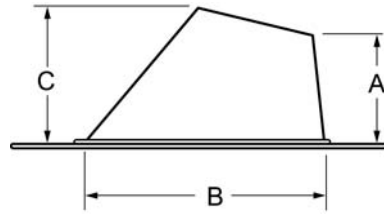

Model Number	Size	Dim. A	Dim. B	Dim. C.
3RF	3"	3"	6 ¹ / ₈ "	4 ¹ / ₈ "
4RF	4"	3 ¹ / ₄ "	7 ³ / ₈ "	4 ¹ / ₈ "
5RF	5"	3 ¹ / ₂ "	8 ⁵ / ₈ "	4 ³ / ₄ "
6RF	6"	3 ³ / ₄ "	10"	5 ¹ / ₄ "
7RF	7"	4"	11 ¹ / ₈ "	6 ³ / ₈ "
8RF	8"	4 ¹ / ₄ "	13 ¹ / ₈ "	6 ³ / ₄ "
10RF	10"	4 ³ / ₄ "	15 ⁵ / ₈ "	7 ¹ / ₂ "
12RF	12"	4 ³ / ₄ "	18"	8"
14RF	14"	5 ¹ / ₄ "	21"	9 ¹ / ₄ "
16RF	16"	5 ¹ / ₄ "	23 ¹ / ₄ "	9 ¹ / ₂ "
18RF	18"	5 ³ / ₄ "	25 ⁷ / ₈ "	10 ¹ / ₂ "
20RF	20"	5 ³ / ₄ "	28 ¹ / ₈ "	11"
22RF	22"	6 ¹ / ₄ "	30 ⁵ / ₈ "	12"
24RF	24"	6 ¹ / ₄ "	32 ⁷ / ₈ "	12 ¹ / ₂ "
26RF	26"	NA	NA	12"
28RF	28"	NA	NA	12"
30RF	30"	NA	NA	13"

NA = Not Available

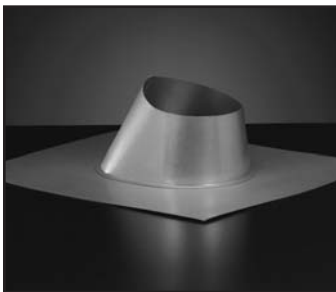

RFA Adjustable Roof Flashing 6/12 to 12/12

- Available in 3" through 8"

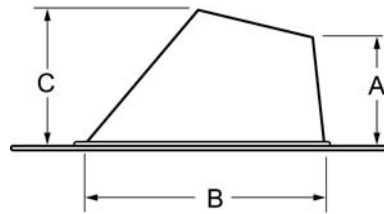

Model Number	Size	Dim. A	Dim. B	Dim. C.
3RFA	3"	5 ¹ / ₂ "	6"	7 ¹ / ₄ "
4RFA	4"	5 ³ / ₈ "	7 ³ / ₈ "	7 ⁹ / ₁₆ "
5RFA	5"	5 ⁵ / ₈ "	8 ⁵ / ₈ "	8 ⁵ / ₈ "
6RFA	6"	5 ³ / ₈ "	10"	8 ¹³ / ₁₆ "
7RFA	7"	5 ³ / ₈ "	11 ⁷ / ₈ "	9 ³ / ₄ "
8RFA	8"	5 ¹ / ₄ "	13"	10 ¹ / ₁₆ "



RTF Tall Cone Roof Flashing

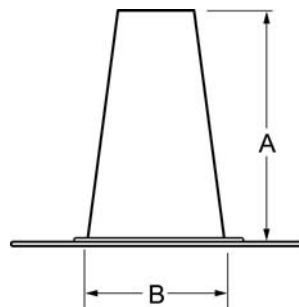

Model Number	Size	Dim. A.	Dim. B.
3RTF	3"	11"	7 ¹ / ₂ "
4RTF	4"	11"	7 ¹ / ₂ "
5RTF	5"	11"	7 ¹ / ₂ "
6RTF	6"	11"	7 ¹ / ₂ "
7RTF	7"	11"	11"
8RTF	8"	11"	11"
10RTF	10"	11"	16"
12RTF	12"	11"	16"
14RTF	14"	11"	19 ¹ / ₄ "
16RTF	16"	11"	19 ¹ / ₄ "
18RTF	18"	11"	23 ⁵ / ₈ "
20RTF	20"	11"	23 ⁵ / ₈ "
22RTF	22"	11"	27 ⁵ / ₈ "
24RTF	24"	11"	27 ⁵ / ₈ "
26RTF	26"	11"	31 ⁹ / ₁₆ "
28RTF	28"	11"	31 ⁹ / ₁₆ "
30RTF	30"	11"	31 ⁹ / ₁₆ "



RS Storm Collar
3" through 6"

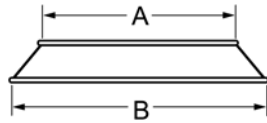

Model Number	Size	Dim. A	Dim. B
3RS	3"	3 ¹ / ₂ "	6 ⁵ / ₈ "
4RS	4"	4 ¹ / ₂ "	7 ⁵ / ₈ "
5RS	5"	5 ¹ / ₂ "	8 ⁵ / ₈ "
6RS	6"	6 ¹ / ₂ "	9 ⁵ / ₈ "



RS Adjustable Storm Collar
7" through 12"

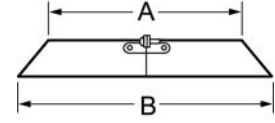

Model Number	Size	Dim. A	Dim. B
7RS	7"	8"	10 ⁷ / ₈ "
8RS	8"	9"	11 ⁷ / ₈ "
10RS	10"	11"	14 ¹ / ₂ "
12RS	12"	13"	16 ¹ / ₂ "



SC Adjustable Storm Collar
14" through 30"

- Designed to be snug around vent pipe for a weather-tight fit.
- For use with roof flashing and caulk.

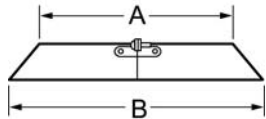

Model Number	Size	Dim. A	Dim. B
14SC	14"	15"	18 ⁷ / ₈ "
16SC	16"	17"	21 ¹ / ₄ "
18SC	18"	19"	23 ¹ / ₄ "
20SC	20"	21"	25 ¹⁵ / ₁₆ "
22SC	22"	23"	28 ⁵ / ₁₆ "
24SC	24"	25"	30 ¹¹ / ₁₆ "
26SC	26"	27"	33 ¹ / ₁₆ "
28SC	28"	29"	35 ¹ / ₁₆ "
30SC	30"	31"	37 ¹ / ₁₆ "

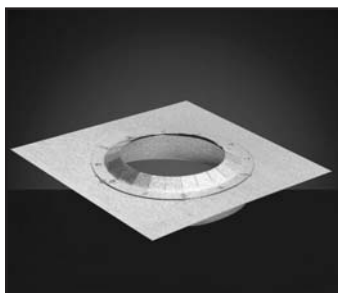

RGS* Gripper Support
3" through 6"

- Supports 30 feet of pipe.
- Acts as a firestop.
- 7", 8" and 10" not UL-listed.

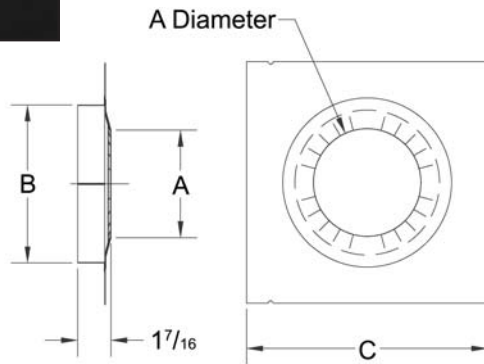

Model Number	Size	Dim. A	Dim. B	Dim. C Square
3RGS	3"	3 ¹ / ₂ "	5 ¹ / ₂ "	9"
4RGS	4"	4 ¹ / ₂ "	6 ¹ / ₂ "	10"
5RGS	5"	5 ¹ / ₂ "	7 ¹ / ₂ "	11"
6RGS	6"	6 ¹ / ₂ "	8 ¹ / ₂ "	12"
7RGS	7"	7 ¹ / ₂ "	-	13"
8RGS	8"	8 ¹ / ₂ "	-	14"
10RGS	10"	10 ¹ / ₂ "	-	16"

*Denotes UL listing

Type B Round Gas Vent Pipe & Fittings



RSA* Support Assembly 3" through 12"

- Supports 60 feet of pipe.
- Acts as a firestop.

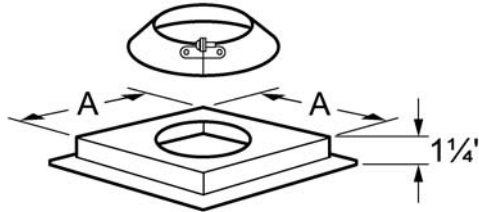

Model Number	Size	Dim. A
3RSA	3"	5 ⁵ / ₈ "
4RSA	4"	6 ⁵ / ₈ "
5RSA	5"	7 ⁵ / ₈ "
6RSA	6"	8 ⁵ / ₈ "
7RSA	7"	10 ¹ / ₈ "
8RSA	8"	11 ¹ / ₈ "
10RSA	10"	13 ¹ / ₈ "
12RSA	12"	15 ¹ / ₈ "

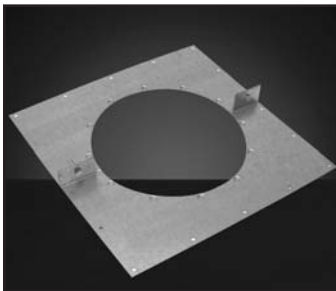

SP* Support Plate

- Supports 60 feet of pipe.

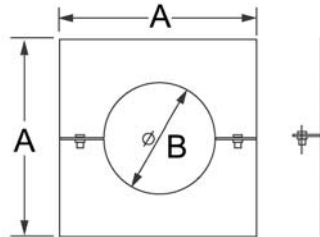

Model Number	Size	Dim. A	Dim. B
14SP	14"	14 ⁵ / ₈ "	14"
16SP	16"	16 ⁵ / ₈ "	16"
18SP	18"	18 ⁵ / ₈ "	18"
20SP	20"	20 ⁵ / ₈ "	20"
22SP	22"	22 ⁵ / ₈ "	22"
24SP	24"	24 ⁵ / ₈ "	24"
26SP	26"	26 ⁵ / ₈ "	26"
28SP	28"	28 ⁵ / ₈ "	28"
30SP	30"	30 ⁵ / ₈ "	30"

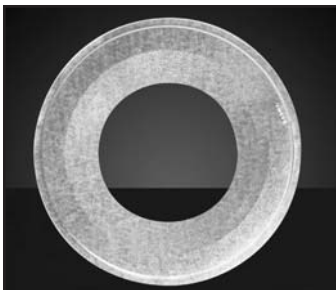

RPC Pipe Collar 3" through 8"

- To cover a rough opening.

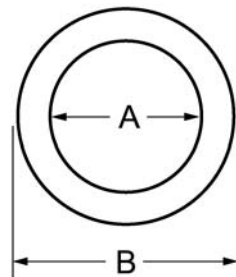

Model Number	Size	Dim. A	Dim. B
3RPC	3"	3 ⁵ / ₈ "	8 ³ / ₄ "
4RPC	4"	4 ⁵ / ₈ "	8 ³ / ₄ "
5RPC	5"	5 ⁵ / ₈ "	10 ⁷ / ₈ "
6RPC	6"	6 ⁵ / ₈ "	12 ⁷ / ₈ "
7RPC	7"	8 ¹ / ₈ "	14 ⁷ / ₈ "
8RPC	8"	9 ¹ / ₈ "	16 ⁷ / ₈ "



RWT Wall Thimble

- Provides necessary clearance to combustibles.
- Sleeve is adjustable from 3½" to 6¼".

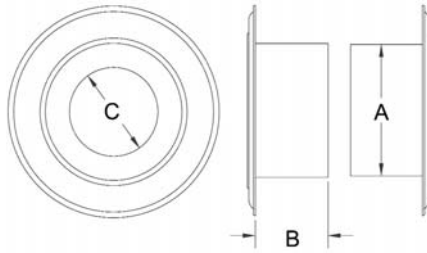

Model Number	Size	Dim. A	Dim. B	Dim. C
3RWT	3"	5½"	3¹⁄₁₆"	3⁹⁄₁₆"
4RWT	4"	6½"	3¹⁄₁₆"	4⁹⁄₁₆"
5RWT	5"	7½"	3¹⁄₁₆"	5⁹⁄₁₆"
6RWT	6"	8½"	3¼"	6⁹⁄₁₆"
7RWT	7"	10"	3¼"	8¹⁄₁₆"
8RWT	8"	11"	3¼"	9¹⁄₁₆"



3" through 7"



8" through 12"

RWB Wall Bracket

- Available in 3" through 12".
- 8" through 12" bracket used with perforated pipe strap supplied by others.

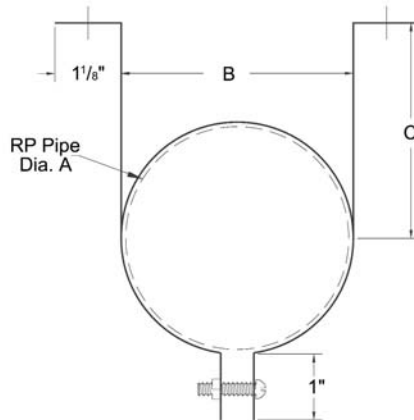

Model Number	Size	Dim. A	Dim. B	Dim. C
3RWB	3"	3"	3½"	3¼"
4RWB	4"	4"	4½"	3¾"
5RWB	5"	5"	5½"	4¼"
6RWB	6"	6"	6½"	4¾"
7RWB	7"	7"	8"	5½"
8RWB	8"	8"	-	-
10RWB	10"	10"	-	-
12RWB	12"	12"	-	-

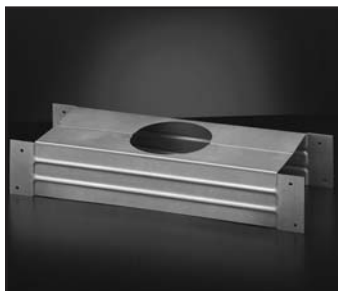

RFS* Firestop Spacer

- Fits 2" x 6" wall.
- Available in 4" only.
- For other firestops, see installation instructions.

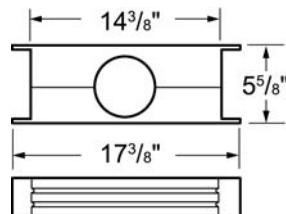

*Denotes UL listing



SFC Single-Wall Flexible Gas Vent Connector

- Single-wall flexible construction.
- Includes an integral appliance draft hood connector for fast installation.
- Locks onto Hart & Cooley Type B gas vent.
- Requires only 1" clearance to combustibles per installation instructions.
- UL-listed for use as a connection from an appliance to Type B gas vent in conditioned spaces only. Do not enclose.
- Available in 3" through 5" diameters and 1' through 5' lengths.

Diameter	Model Number	Length
3"	3SFC12	12"
	3SFC24	24"
	3SFC3	36"
	3SFC4	48"
	3SFC5	60"
4"	4SFC12	12"
	4SFC24	24"
	4SFC3	36"
	4SFC4	48"
	4SFC5	60"
5"	5SFC12	12"
	5SFC24	24"
	5SFC3	36"
	5SFC4	48"
	5SFC5	60"



DFC Double-Wall Flexible Gas Vent Segment

- Features double-wall, air-insulated construction.
- Has Type B male/female ends for easy connection with Hart & Cooley vent.
- Requires only 1" clearance to combustibles.
- UL-listed for use as a connection from an appliance to Type B gas vent and as a segment of Type B gas vent.
- Can be used in unconditioned spaces, such as attics and crawl spaces. Do not enclose.
- Available in 3" through 5" diameters and 2' through 5' lengths.

Diameter	Model Number	Length
3"	3DFC24	24"
	3DFC3	36"
	3DFC4	48"
	3DFC5	60"
4"	4DFC24	24"
	4DFC3	36"
	4DFC4	48"
	4DFC5	60"
5"	5DFC24	24"
	5DFC3	36"
	5DFC4	48"
	5DFC5	60"



OP Oval Pipe

- Offers all the advantages of round pipe, and may be used for the following types of installation.

4" Oval:

Conventional Type B
Type B-2x4 when used with firestop
Type BW-2x4 with recessed heater

5" Oval:

Type B
Type B-2x4

Lengths for 4" Sizes:

6", 12", 18", 24", 3', 4', 5'

Lengths for 5" Sizes:

18", 24", 3', 4', 5'

Model Number	Size	Dim. A	Dim. B
4OP_*	4"	7 ¹ / ₁₆ "	2 ⁷ / ₈ "
5OP_*	5"	10 ³ / ₄ "	2 ⁷ / ₈ "

*Add length to complete Model Number.

TYPE B

Sizes 4" and 5" may be installed with 1" minimum clearance to combustibles.

TYPE BW (recessed heater)

Four-inch oval vent (when installed in 2 x 4 stud wall with recessed heater) requires clearances as determined by use of 4OBPWS hold-down plate, 4OCP ceiling plate spacers, and 4OFS firestop spacers.

TYPE B 2x4

Four- and five-inch oval vent (when installed in 2 x 4 stud wall, not using a recessed heater) requires clearance as determined by use of 4OFS or 5OFS firestop spacers at each ceiling level.

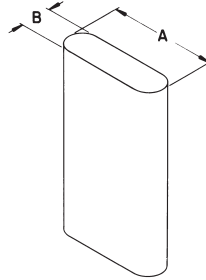

OPA Adjustable Oval Pipe

- The adjustable length telescopes onto standard pipe sections to permit adjustments from 3" to 10".

Sizes for 12" Lengths:

4", 5" (adjustable from 3" to 10")

Model Number	Size
4OPA	4"
5OPA	5"



OES45 Elbow - Standard

- The standard 45° elbow is used in pairs where offsets are desired in 1" minimum clearance enclosures or open spaces, such as attics or basements. Add pipe sections between pairs to produce additional offset.

Model Number	Size	Dim. A	Dim. B
4OES45	4"	3"	3"
5OES45	5"	3 ¹ / ₂ "	3 ¹ / ₂ "

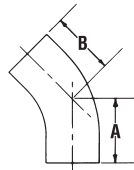

Type B Oval Gas Vent Pipe & Fittings



OEF45 Elbow – Flat

- The flat 45° elbow is used in pairs where offsets are desired in 1" minimum clearance enclosures or open spaces, such as attics or basements. Add pipe sections between pairs to produce additional offset.

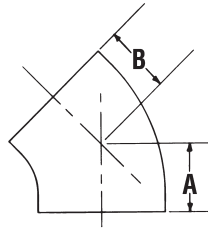

Model Number	Size	Dim. A	Dim. B
4OEF45	4"	3 ³ / ₄ "	3 ³ / ₄ "
5OEF45	5"	4 ³ / ₄ "	4 ³ / ₄ "



OT Standard Oval Tee

- The branch size and trunk size have the same diameter. The tee branch accepts either double- or single-wall pipe.

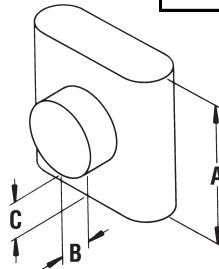

Model Number	Size	Dim. A	Dim. B	Dim. C
4OT	4"	12"	2 ⁹ / ₁₆ "	2 ³ / ₈ "
5OT	5"	12"	2 ⁹ / ₁₆ "	2 ³ / ₈ "

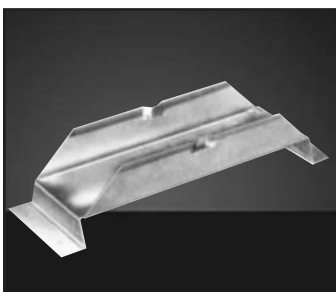

OBC Tee Support

- The tee support is used to support and center the tee. Use with the tee cap shown below.

Model Number	Size
4OBC	4"
5OBC	5"



OTC Oval Tee Cap

- The tee cap is used for closing off the bottom of the tee.

Model Number	Size
4OTC	4"
5OTC	5"



OAR* Adapter (oval to round)

- Adapts from snap-lock oval to locking style round.

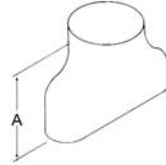

Model Number	Size	Dim. A
4OAR	4"	11 ³ / ₈ "



OARA Oval-to-Round Adapter

- The oval-to-round adapter is used for conversion of vent from oval to round.
- Requires use of RAA male adapter to continue with round.

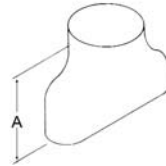

Model Number	Size	Dim. A
4OARA	4"	6 ⁷ / ₈ "
5OA5RA	5"	9 ³ / ₈ "



RAO Round-to-Oval Adapter

- The round-to-oval adapter is used for conversion of vent from round to oval.
- Requires use of RRA female adapter to come from round.

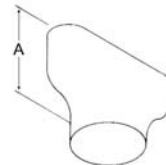

Model Number	Size	Dim. A
4RAO	4"	6 ⁷ / ₈ "
5RA5O	5"	9 ³ / ₈ "

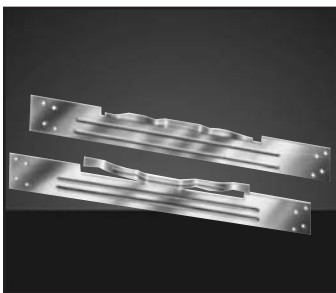

OCP Plate Spacers

- Type BW plate spacers are required at the first ceiling level above a wall furnace to center and space vent properly and to provide the required opening between floors. Firestop spacers must be used at subsequent levels.

Model Number	Size
4OCP	4"

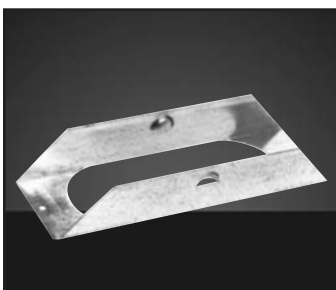

OBPWS Hold-Down Plate

- The Type BW hold-down plate is required for connecting Type BW vent to a wall furnace outlet.

Model Number	Size
4OBPWS	4"

*Denotes UL listing

Type B Oval Gas Vent Pipe & Fittings

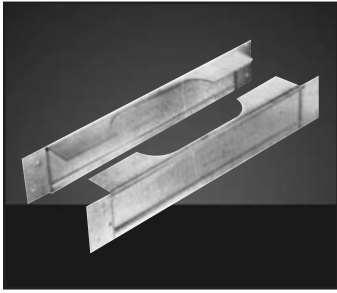

OFS Firestop Spacers

- The firestop spacers center vent in 16" O.C. stud space and serve as a firestop at the ceiling level. This is a required component for Type B 2 x 4 and multi-story Type BW installations.

Model Number	Size	Wall
4OFS	4"	2" x 4"
5OFS	5"	2" x 4"
4OFS6	4"	2" x 6"



OC 4" Oval Cap

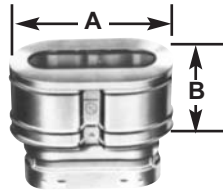

Model Number	Size	Dim. A	Dim. B
OC	4"	5 ³ / ₈ " x 8 ¹ / ₂ "	3 ¹ / ₂ "



ECW 5" Cap

- Requires use of 5OA5RA.

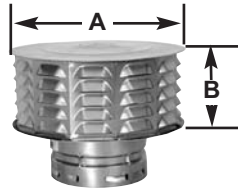

Model Number	Size	Dim. A	Dim. B
5ECW	5"	9 ⁷ / ₈ "	5 ⁵ / ₁₆ "

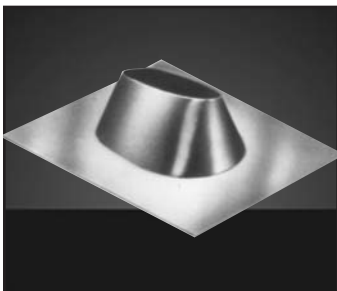

OF Oval Flashing

- The all-pitch flashing is installed either parallel or perpendicular to the roof ridge, and fits roof pitches flat to 5/12.

Model Number	Size
4OF	4"
5OF	5"



OSC Oval Storm Collar

- The storm collar serves as a counter flashing and requires mastic to seal to the vent pipe.

Model Number	Size
4OSC	4"
5OSC	5"

Typical Type B Gas Vent Installations

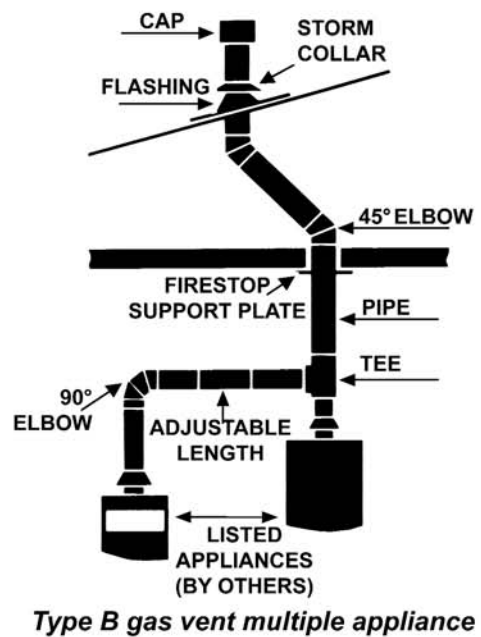
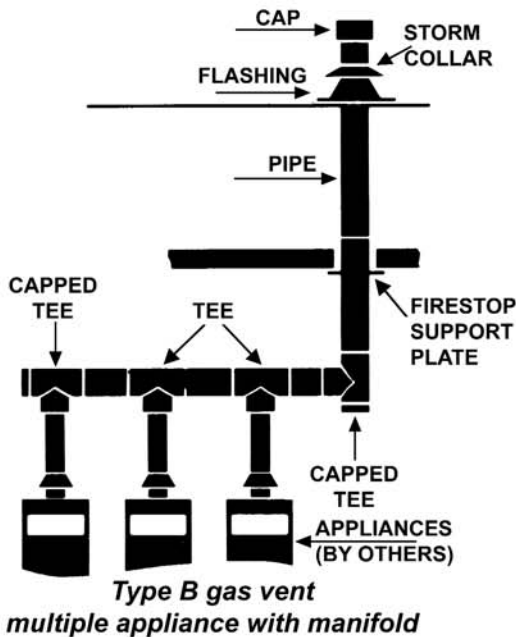
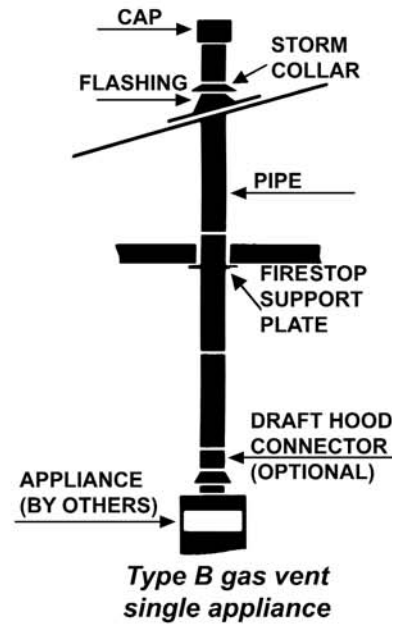
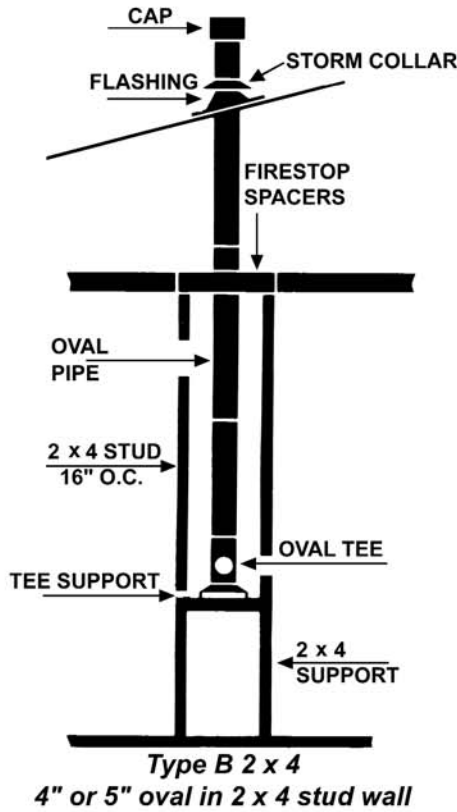
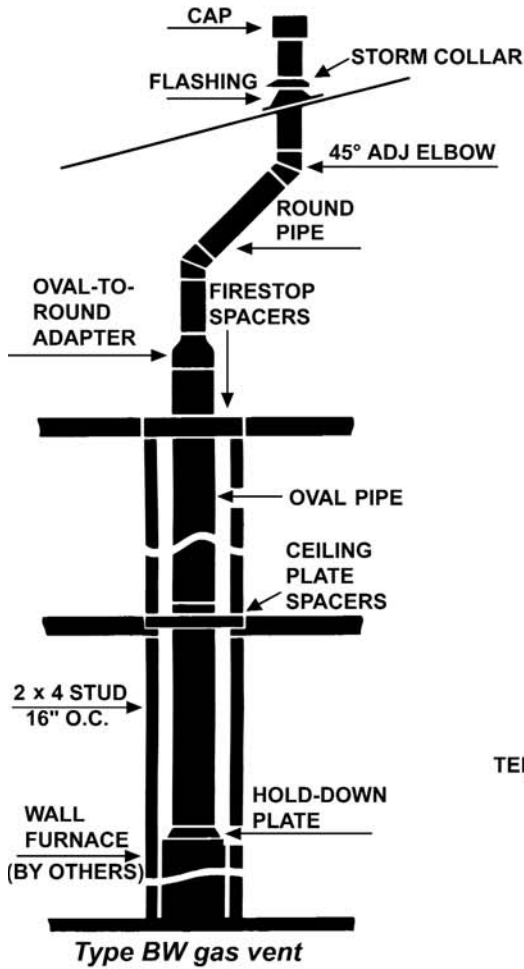



RLK* Basic Kit

- Available in 3", 4", 5", 6", 7", 8" diameter.
- Available in 25' and 35' lengths.
- UL -listed.
- Compatible with Type B gas vent systems.
- Simple connections. Easy installation.
- Kit includes flexible aluminum liner, cap, termination fitting, flashing, mortar sleeve and a single-wall collar, screws and installation instructions.

Model Number	Size	Listed Length	Model Number	Size	Listed Length
3RLK25	3"	25'	6RLK25	6"	25'
3RLK35	3"	35'	6RLK35	6"	35'
4RLK25	4"	25'	7RLK25	7"	25'
4RLK35	4"	35'	7RLK35	7"	35'
5RLK25	5"	25'	8RLK25	8"	25'
5RLK35	5"	35'	8RLK35	8"	35'

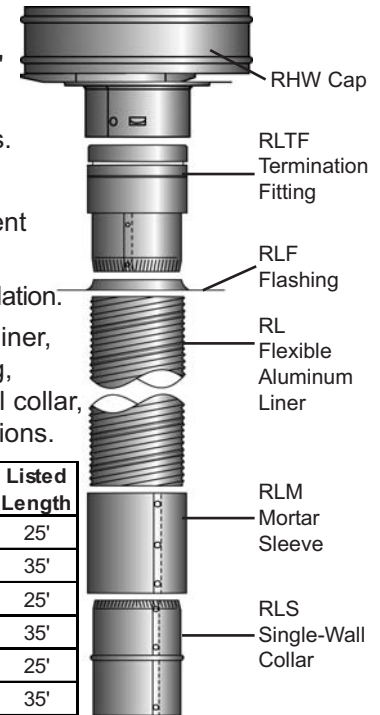

Note: RLPC Pulling Cone and RLA Female B-Vent Adapter sold separately.



RLKE* Extension Kit

- Contains 5', 10' or 15' flexible aluminum liner.
- Includes attached single-wall collar, screws and installation instructions.
- 7" and 8" available upon request.
- UL- and CUL-listed.
- 5' - 6 pieces/box
10' and 15' - 1 piece/box

Model Number	Size	Listed Length	Model Number	Size	Listed Length
3RLKE5	3"	5'	5RLKE5	5"	5'
3RLKE10	3"	10'	5RLKE10	5"	10'
3RLKE15	3"	15'	5RLKE15	5"	15'
4RLKE5	4"	5'	6RLKE5	6"	5'
4RLKE10	4"	10'	6RLKE10	6"	10'
4RLKE15	4"	15'	6RLKE15	6"	15'



RLA Female B-Vent Adapter

- Sold separately; not part of kit.

Model Number	Size	Dim. A	Dim. B
3RLA	3"	3"	5 ⁵ / ₈ "
4RLA	4"	4"	5 ⁵ / ₈ "
5RLA	5"	5"	5 ⁵ / ₈ "
6RLA	6"	6"	5 ⁵ / ₈ "
7RLA	7"	7"	5 ⁵ / ₈ "
8RLA	8"	8"	5 ⁵ / ₈ "

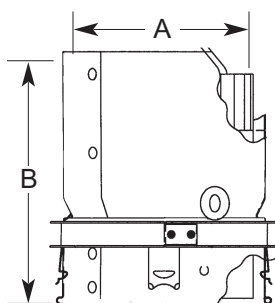

RLPC Pulling Cone

- Sold separately; not part of kit.

Model Number	Size	Dim. A	Dim. B
3RLPC	3"	3 ¹ / ₂ "	4 ³ / ₈ "
4RLPC	4"	4 ¹ / ₂ "	5"
5RLPC	5"	5 ¹ / ₂ "	5"
6RLPC	6"	6 ¹ / ₂ "	5"
7RLPC	7"	7 ¹ / ₂ "	5"
8RLPC	8"	8 ¹ / ₂ "	5"

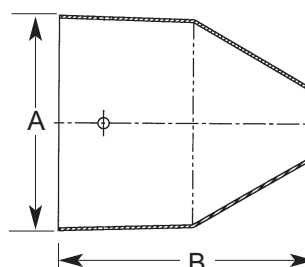

*Denotes UL listing

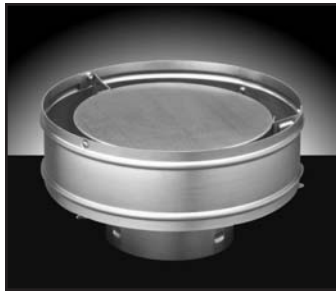

RHW* Metal Cap (High Wind)

Model Number	Size	Dim. A	Dim. B
3RHW	3"	8 ¹ / ₄ "	4 ¹ / ₂ "
4RHW	4"	9 ¹ / ₄ "	4 ⁷ / ₈ "
5RHW	5"	10 ¹ / ₂ "	5 ¹ / ₄ "
6RHW	6"	11 ¹ / ₄ "	5 ⁵ / ₈ "

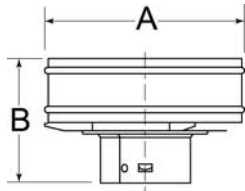

RM Metal Cap

Model Number	Size	Dim. A	Dim. B
7RM	7"	14 ¹ / ₈ "	6 ⁷ / ₈ "
8RM	8"	15 ¹ / ₈ "	7"

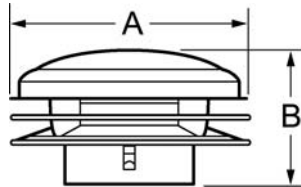

RLTF Termination Fitting

Model Number	Size	Dim. A	Dim. B
3RLTF	3"	3"	5"
4RLTF	4"	4"	5"
5RLTF	5"	5"	5"
6RLTF	6"	6"	5"
7RLTF	7"	7"	5"
8RLTF	8"	8"	5"

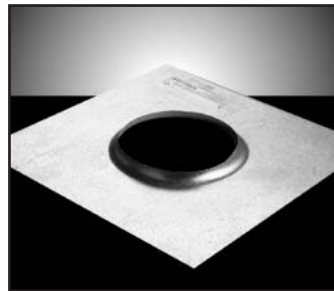
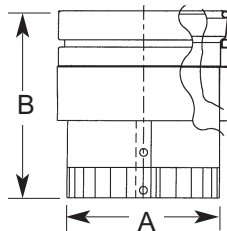

RLF Flashing

Model Number	Size	Dim. A
3RLF	3"	3"
4RLF	4"	4"
5RLF	5"	5"
6RLF	6"	6"
7RLF	7"	7"
8RLF	8"	8"

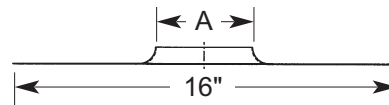

RLM Mortar Sleeve

Model Number	Size	Dim. A	Dim. B
3RLM	3"	3 ¹ / ₂ "	6 ¹ / ₈ "
4RLM	4"	4 ¹ / ₂ "	6 ¹ / ₈ "
5RLM	5"	5 ¹ / ₂ "	6 ¹ / ₈ "
6RLM	6"	6 ¹ / ₂ "	6 ¹ / ₈ "
7RLM	7"	7 ¹ / ₂ "	6 ¹ / ₈ "
8RLM	8"	8 ¹ / ₂ "	6 ¹ / ₈ "

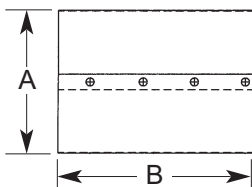

RLS Single-Wall Collar

Model Number	Size	Dim. A	Dim. B
3RLS	3"	3"	5"
4RLS	4"	4"	5"
5RLS	5"	5"	5"
6RLS	6"	6"	5"
7RLS	7"	7"	5"
8RLS	8"	8"	5"

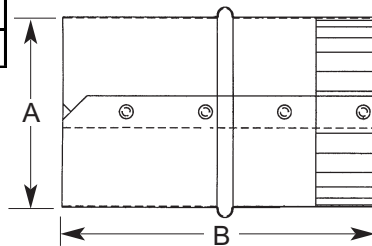

*Denotes UL listing

Check out other quality Hart & Cooley products...

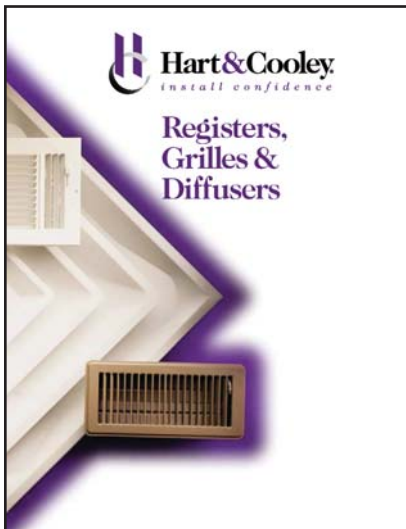

Form No. 010050

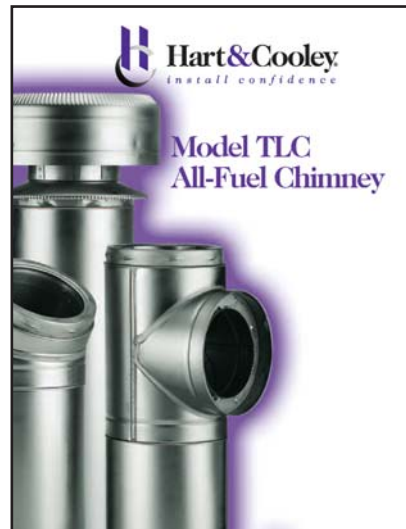

Form No. 851343

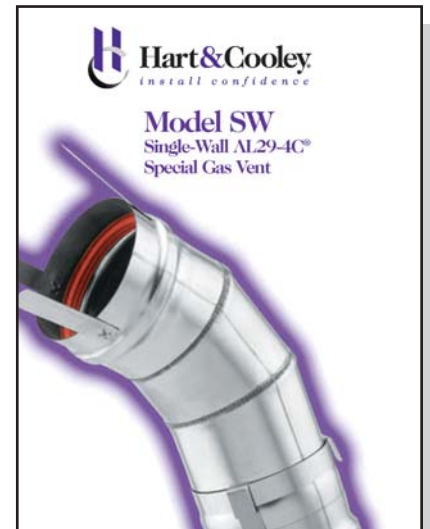

Form No. 851369

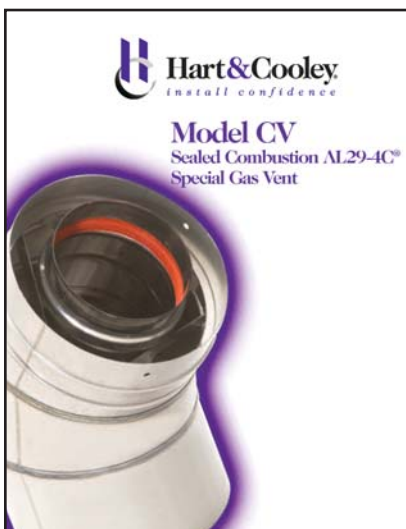

Form No. 851367



Form No. 851095

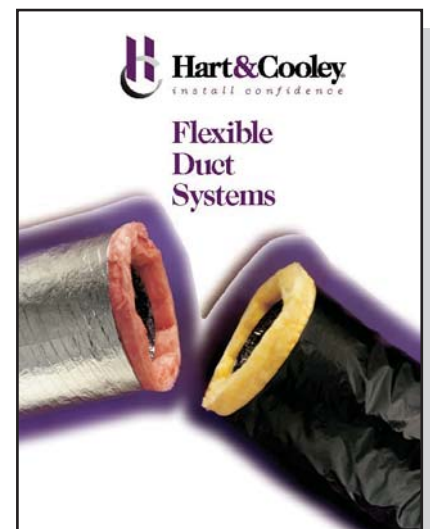

Form No. 010054

To order any of the above catalogs, please contact
Customer Service toll-free at 800.433.6341.



Hart & Cooley
install confidence

Hart & Cooley, Inc. 800.433.6341 *p*
5030 Corporate Exchange Blvd. SE 616.656.8200 *p*
Grand Rapids, MI 49512 800.223.8461 *f*
info@hartcool.com 616.656.6399 *f*
www.hartandcooley.com

Offered by:

www.hartandcooley.com

For submittal information and other literature visit our Website.

