

R110 Valve Body Shown

GENERAL DESCRIPTION:

Cast brass body, washerless ceramic disc valve cartridge with back-to-back capability, integrated check valves and hot limit safety stop. Cycles from "off" to "cold" to "hot". Pressure balancing cartridge maintains constant output temperature in response to changes in relative hot and cold supply pressure. One-half inch inlets and outlets (choice of universal, direct sweat, threaded, PEX or CPVC). Available with screwdriver stops. Rough-in plaster guard designed for use as thin-wall mounting adaptor. Valve body will accept a variety of decorative Bath/Shower trims.

PRODUCT FEATURES:

Cast Brass Valve Body: Durable - Quality that will last a lifetime. Ideal material for prolonged contact with water.

Ceramic Disc Valve Cartridge: Assures a lifetime of drip-free performance. Allows easy fine tuning of temperature (125° handle rotation from off to hot).

Pressure Balancing Valve Cartridge: Maintains constant output temperature in response to changes in hot and cold supply pressure. Diaphragm system with integrated check valves engineered to eliminate cross flow. Avoids failure due to mineral deposits - ideal for use in hard water.

Back-to-Back Capability: Hot and cold can be reversed quickly and easily.

Adjustable Hot Limit Safety Stop: Limits the amount of hot water allowed to mix with cold. Reduces the risk of accidental scalding.

Exclusive Plaster Guard: Plaster guard is designed to protect valve during installation and serve as a mounting plate for thin-wall installations. 2-piece design allows valve to be tested prior to trim installation.

Wide Rough-in Range: From 1-5/8" to 3-1/4".

SUGGESTED SPECIFICATION:

Bath/shower fitting shall feature a cast brass body. Shall feature ceramic disc valve cartridge which is capable of back-to-back installation. Fitting shall be equipped with pressure balancing cartridge engineered to eliminate cross flow and avoid failure due to mineral deposits. Shall also feature hot limit safety stop. Fitting shall be: Rough Valve Body - American Standard Model # R11____, Trim Kit - American Standard Model # ____.

MODEL NUMBER:

- R111 Pressure Balance Rough Valve Body only**
Universal inlets/outlets. LESS trim.
- R111SS Pressure Balance Rough Valve Body only with Screwdriver stops**
Universal inlets/outlets. Screwdriver stops. LESS trim.
- R110 Pressure Balance Rough Valve Body only**
Direct sweat inlets/outlets. LESS trim.
- R110SS Pressure Balance Rough Valve Body only with Screwdriver stops**
Direct sweat inlets/outlets. Screwdriver stops. LESS trim.
- R115 Pressure Balance Rough Valve Body only**
Female thread inlets/outlets. LESS trim.
- R115SS Pressure Balance Rough Valve Body only with Screwdriver stops**
Female thread inlets/outlets. Screwdriver stops. LESS trim.
- R117 Pressure Balance Rough Valve Body only**
PEX inlets/universal outlets for Crimp Ring PEX system (ASTM F1807) LESS trim.
- R117SS Pressure Balance Rough Valve Body only with Screwdriver stops**
PEX inlets/universal outlets for Crimp Ring PEX system (ASTM F1807) Screwdriver stops. LESS trim.
- R118 Pressure Balance Rough Valve Body only**
PEX inlets/universal outlets for Cold Expansion PEX system (ASTM F1960) LESS trim.
- R118SS Pressure Balance Rough Valve Body only with Screwdriver stops**
PEX inlets/universal outlets for Cold Expansion PEX system (ASTM F1960) Screwdriver stops. LESS trim.
- R119 Pressure Balance Rough Valve Body only**
CPVC inlets/universal outlets. LESS trim.
- R119SS Pressure Balance Rough Valve Body only with Screwdriver stops**
CPVC inlets/universal outlets. Screwdriver stops. LESS trim.

See reverse side for dimensional valve drawings.

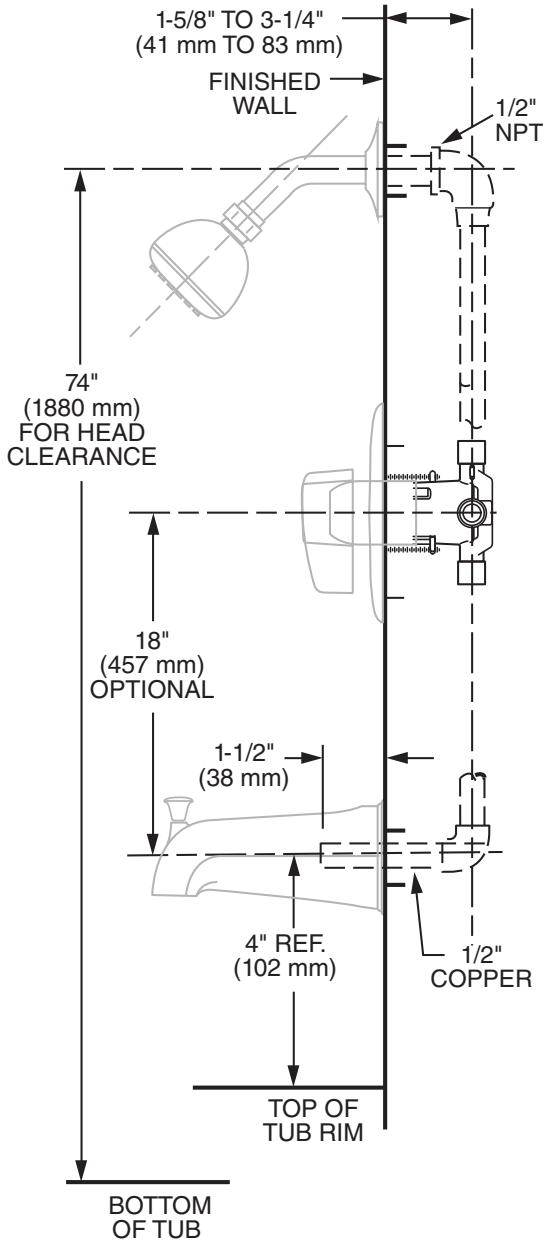

ROUGH VALVE OPTIONS











<p>INLETS 1/2" NOM COPPER SWEAT or 1/2" NPT</p> <p>OUTLETS 1/2" NOM. COPPER SWEAT or 1/2" NPT</p> <p>4-1/16" (103 mm)</p> <p>4-1/16" (103 mm)</p> <p>MOUNTING BRACKET</p> <p>UNIVERSAL (R111)</p>	<p>INLETS 1/2" NOM COPPER SWEAT or 1/2" NPT</p> <p>OUTLETS 1/2" NOM. COPPER SWEAT or 1/2" NPT</p> <p>5-7/8" (149 mm)</p> <p>4-1/16" (103 mm)</p> <p>MOUNTING BRACKET</p> <p>UNIVERSAL WITH STOPS (R111SS)</p>
<p>INLETS 1/2" NOM. COPPER SWEAT</p> <p>OUTLETS 1/2" NOM. COPPER SWEAT</p> <p>4-1/16" (103 mm)</p> <p>4-1/16" (103 mm)</p> <p>MOUNTING BRACKET</p> <p>SWEAT (R110)</p>	<p>INLETS 1/2" NOM. COPPER SWEAT</p> <p>OUTLETS 1/2" NOM. COPPER SWEAT</p> <p>5-7/8" (149 mm)</p> <p>4-1/16" (103 mm)</p> <p>MOUNTING BRACKET</p> <p>SWEAT WITH STOPS (R110SS)</p>
<p>INLETS 1/2" NPT</p> <p>OUTLETS 1/2" NPT</p> <p>3-3/8" (86 mm)</p> <p>3-3/8" (86 mm)</p> <p>MOUNTING BRACKET</p> <p>THREADED (R115)</p>	<p>INLETS 1/2" NPT</p> <p>OUTLETS 1/2" NPT</p> <p>5-7/8" (149 mm)</p> <p>3-3/8" (86 mm)</p> <p>MOUNTING BRACKET</p> <p>THREADED WITH STOPS (R115SS)</p>
<p>INLETS 1/2" PEX (ASTM F1807)</p> <p>OUTLETS 1/2" NOM. COPPER SWEAT or 1/2" NPT</p> <p>4-1/4" (109 mm)</p> <p>4-1/16" (103 mm)</p> <p>MOUNTING BRACKET</p> <p>PEX (R117) ASTM F1807</p>	<p>INLETS 1/2" PEX (ASTM F1807)</p> <p>OUTLETS 1/2" NOM. COPPER SWEAT or 1/2" NPT</p> <p>6-1/2" (165 mm)</p> <p>4-1/16" (103 mm)</p> <p>MOUNTING BRACKET</p> <p>PEX WITH STOPS (R117SS) ASTM F1807</p>
<p>INLETS 1/2" PEX (ASTM F1960)</p> <p>OUTLETS 1/2" NOM. COPPER SWEAT or 1/2" NPT</p> <p>4-1/4" (109 mm)</p> <p>4-1/16" (103 mm)</p> <p>MOUNTING BRACKET</p> <p>PEX (R118) ASTM F1960</p>	<p>INLETS 1/2" PEX (ASTM F1960)</p> <p>OUTLETS 1/2" NOM. COPPER SWEAT or 1/2" NPT</p> <p>6-1/2" (165 mm)</p> <p>4-1/16" (103 mm)</p> <p>MOUNTING BRACKET</p> <p>PEX WITH STOPS (R118SS) ASTM F1960</p>
<p>INLETS 1/2" NOM. CPVC</p> <p>OUTLETS 1/2" NOM. COPPER SWEAT or 1/2" NPT</p> <p>6-5/16" (160 mm)</p> <p>4-1/16" (103 mm)</p> <p>MOUNTING BRACKET</p> <p>CPVC (R119)</p>	<p>INLETS 1/2" NOM. CPVC</p> <p>OUTLETS 1/2" NOM. COPPER SWEAT or 1/2" NPT</p> <p>7-15/16" (202 mm)</p> <p>4-1/16" (103 mm)</p> <p>MOUNTING BRACKET</p> <p>CPVC WITH STOPS (R119SS)</p>

Valve + Trim: Trim Kit & Valve Body Packaged Separately

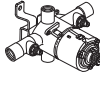
To order: Specify valve body **and** trim kit desired

Example: R110 - Direct Sweat Valve Body

T186.502 - Fluent Bath/Shower Trim Kit

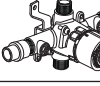

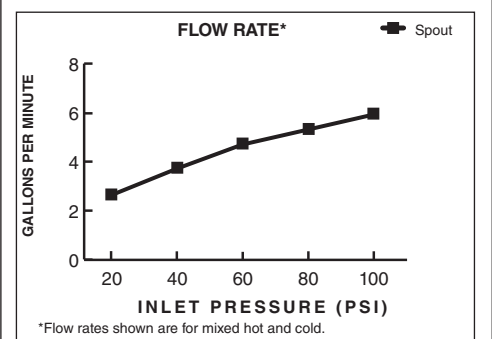









VALVES						
	R111	R111SS	R110	R110SS	R115	R115SS
	Universal Inlets/Outlets	Universal Inlets/Outlets w/ Screwdriver Stops	Direct Sweat Inlets/Outlets	Direct Sweat Inlets/Outlets w/ Screwdriver Stops	Female Thread Inlets/Outlets	Female Thread Inlets/Outlets w/ Screwdriver Stops
						
	R117	R117SS	R118	R118SS	R119	R119SS
	PEX Inlets/Universal Outlets (ASTM F1807)	PEX Inlets/Universal Outlets w/ Screwdriver Stops (ASTM F1807)	PEX Inlets/Universal Outlets (ASTM F 1960)	PEX Inlets/Universal Outlets w/ Screwdriver Stops (ASTM F 1960)	CPVC Inlets/Universal Outlets	CPVC Inlets/Universal Outlets w/ Screwdriver Stops

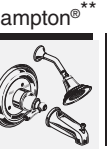
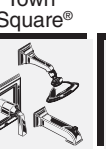
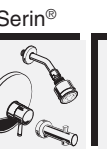
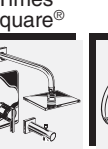

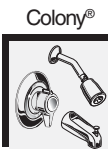
CODES AND STANDARDS

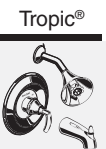

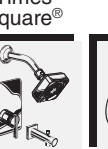

These products meet or exceed the following codes and standards:

- ASSE 1016**
- ASME A112.18.1**
- CSA B 125**



TRIM KITS										
	B/S	T375.XXX	T186.502	T038.502	T028.502	T215.7XX	T555.502	T064.502	T184.502	T430.502
	Shower	T372.XXX	T186.501	T038.501	T028.501	T212.7XX	T555.501	T064.501	T184.501	T430.501
	Valve	T371.XXX	T186.500	T038.500	T028.500	T211.7XX	T555.500	T064.500	T184.500	T430.500
										
	B/S	T375.X28	T186.508	T038.508				T064.508	T184.508	T430.508
	Shower	T372.X28	T186.507	T038.507				T064.507	T184.507	T430.507

NOTES:







* COLONY with 2.5 showerhead with FloWise® showerhead

			
Lever Handle 120	Metal Lever Handle 240	Lever Handle 128	Metal Lever Handle 248

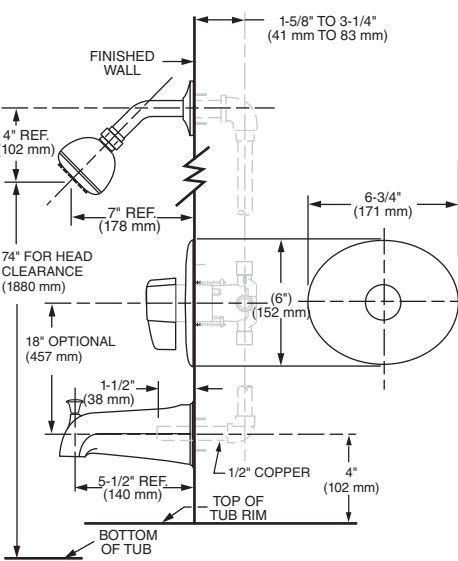

** HAMPTON available with choice of two handles.
to order: specify the three digit handle number
ex) T211.710 (valve only trim kit w/ porcelain lever handle)

	
Porcelain Lever 710	Metal Lever 730

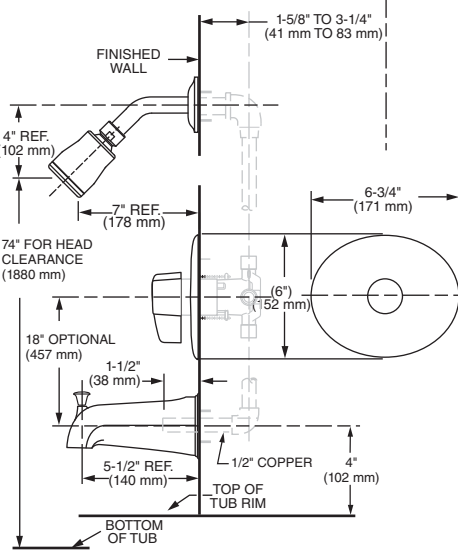

Trim Kits for R110, R110SS, R115, R115SS, R117, R117SS rough valve bodies.
TRIM KITS ONLY. VALVE MUST BE ORDERED SEPARATELY.

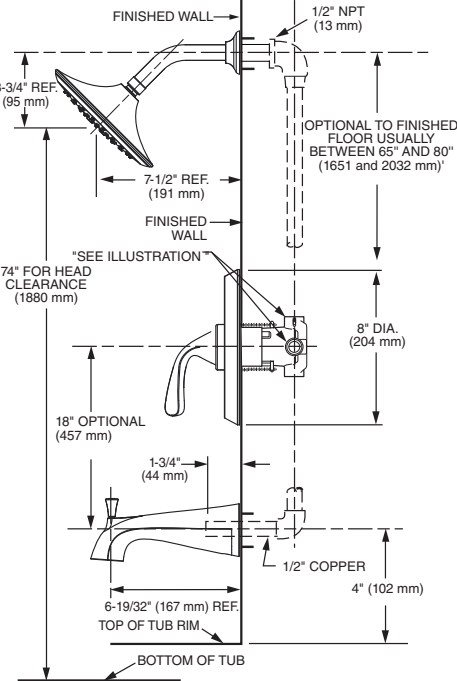
Trim Kit	Model # Description	Finishes	Roughing-In Dimensions
<p>COLONY®</p>  <p>T375.120 BATH/SHOWER Trim Kit</p> <ul style="list-style-type: none"> • Wall escutcheon • Lever handle • "Easy Clean" showerhead • Shower arm and flange • Metal slip-on diverter tub spout <p>T375.240 SAME AS ABOVE</p> <ul style="list-style-type: none"> • With Metal lever handle <p>T372.120 SHOWER ONLY Trim Kit</p> <ul style="list-style-type: none"> • Wall escutcheon • Lever handle • "Easy Clean" showerhead • Shower arm and flange <p>T372.240 SAME AS ABOVE</p> <ul style="list-style-type: none"> • With metal lever handle <p>T371.120 VALVE ONLY Trim Kit</p> <ul style="list-style-type: none"> • Wall escutcheon • Lever handle <p>T371.240 SAME AS ABOVE</p> <ul style="list-style-type: none"> • With metal lever handle <p>2.5 gpm/9.5 L/min. maximum flow rate</p> 	<p>Model # T375.120 BATH/SHOWER Trim Kit</p> <ul style="list-style-type: none"> • Wall escutcheon • Lever handle • "Easy Clean" showerhead • Shower arm and flange • Metal slip-on diverter tub spout <p>T375.240 SAME AS ABOVE</p> <ul style="list-style-type: none"> • With Metal lever handle <p>T372.120 SHOWER ONLY Trim Kit</p> <ul style="list-style-type: none"> • Wall escutcheon • Lever handle • "Easy Clean" showerhead • Shower arm and flange <p>T372.240 SAME AS ABOVE</p> <ul style="list-style-type: none"> • With metal lever handle <p>T371.120 VALVE ONLY Trim Kit</p> <ul style="list-style-type: none"> • Wall escutcheon • Lever handle <p>T371.240 SAME AS ABOVE</p> <ul style="list-style-type: none"> • With metal lever handle <p>2.5 gpm/9.5 L/min. maximum flow rate</p>	<p>.002 Polished Chrome</p>	
<p>COLONY®</p>   <p>T375.128 BATH/SHOWER Trim Kit</p> <ul style="list-style-type: none"> • Wall escutcheon • Lever handle • Water Saving FloWise® showerhead • Angle adjustable • Showerhead, arm and flange • Metal slip-on diverter tub spout <p>T375.248 SAME AS ABOVE</p> <ul style="list-style-type: none"> • Metal lever handle <p>T372.128 BATH/SHOWER Trim Kit</p> <ul style="list-style-type: none"> • Wall escutcheon • Lever handle • Water Saving FloWise® showerhead with arm and flange • Angle adjustable <p>T372.248 SAME AS ABOVE</p> <ul style="list-style-type: none"> • Metal lever handle <p>1.5 gpm/5.7 L/min. maximum flow rate</p>  	<p>Model # T375.128 BATH/SHOWER Trim Kit</p> <ul style="list-style-type: none"> • Wall escutcheon • Lever handle • Water Saving FloWise® showerhead • Angle adjustable • Showerhead, arm and flange • Metal slip-on diverter tub spout <p>T375.248 SAME AS ABOVE</p> <ul style="list-style-type: none"> • Metal lever handle <p>T372.128 BATH/SHOWER Trim Kit</p> <ul style="list-style-type: none"> • Wall escutcheon • Lever handle • Water Saving FloWise® showerhead with arm and flange • Angle adjustable <p>T372.248 SAME AS ABOVE</p> <ul style="list-style-type: none"> • Metal lever handle <p>1.5 gpm/5.7 L/min. maximum flow rate</p>	<p>.002 Polished Chrome</p>	

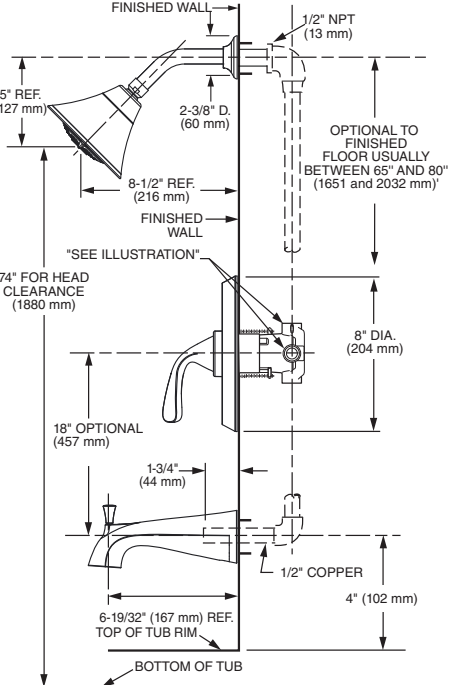



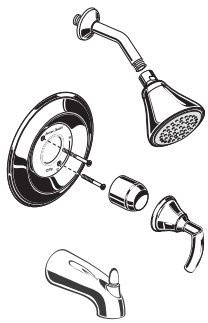
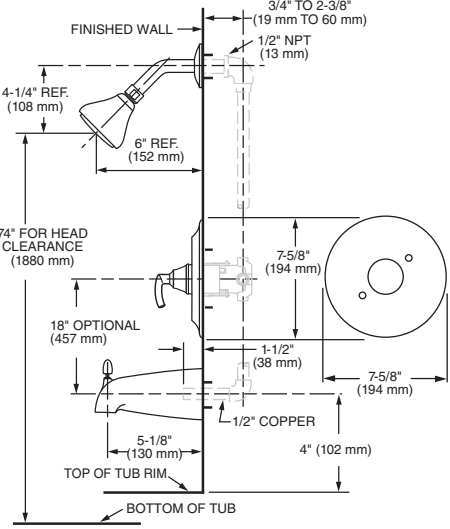

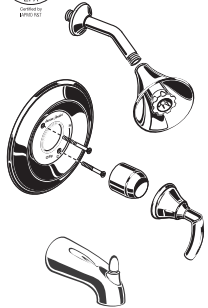
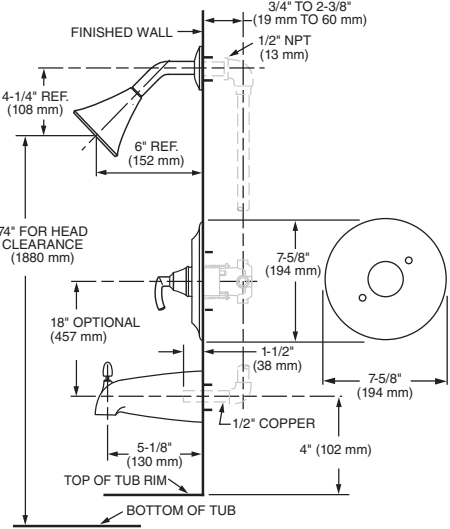

Trim Kits for R110, R110SS, R115, R115SS, R117, R117SS rough valve bodies.
TRIM KITS ONLY. VALVE MUST BE ORDERED SEPARATELY.

Trim Kit	Model # Description	Finishes	Roughing-In Dimensions
<p>FLUENT™</p> 	<p>T186.502 BATH/SHOWER Trim Kit</p> <ul style="list-style-type: none"> • Metal lever handle • Brass wall escutcheon • Showerhead, arm and flange • Metal slip-on diverter tub spout <p>T186.501 SHOWER ONLY Trim Kit</p> <ul style="list-style-type: none"> • Metal lever handle • Brass wall escutcheon • Showerhead, arm and flange <p>T186.500 SHOWER ONLY Trim Kit</p> <ul style="list-style-type: none"> • Metal lever handle • Brass wall escutcheon <p>2.5 gpm/9.5 L/min. maximum flow rate</p>	<p>.002 Polished Chrome .224 Oil Rubbed Bronze .295 Satin Nickel (PVD)</p> <p>.002 Polished Chrome .224 Oil Rubbed Bronze .295 Satin Nickel (PVD)</p> <p>.295 Polished Chrome .224 Oil Rubbed Bronze .295 Satin Nickel (PVD)</p>	
<p>FLUENT™</p> 	<p>T186.508 BATH/SHOWER Trim Kit</p> <ul style="list-style-type: none"> • Metal Lever handle • Brass wall escutcheon • Water Saving FloWise® showerhead with arm and flange • Metal slip-on diverter tub spout • LESS valve <p>T186.507 SHOWER ONLY Trim Kit</p> <ul style="list-style-type: none"> • Metal lever handle • Brass wall escutcheon • Water Saving FloWise® showerhead with arm and flange • LESS Valve <p>2.0 gpm/7.6 L/min. maximum flow rate</p>	<p>.002 Polished Chrome .224 Oil Rubbed Bronze .295 Satin Nickel (PVD)</p> <p>.002 Polished Chrome .224 Oil Rubbed Bronze .295 Satin Nickel (PVD)</p>	

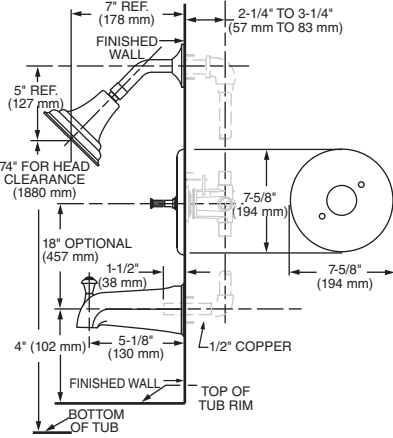
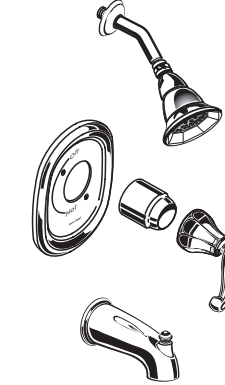

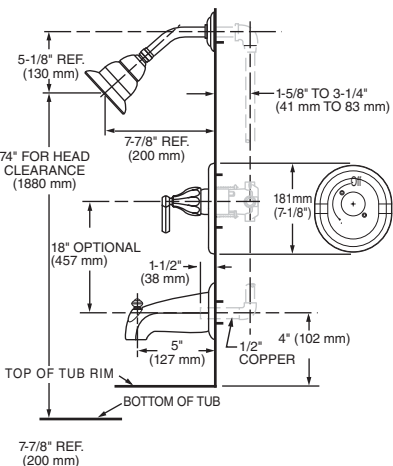
Trim Kits for R110, R110SS, R115, R115SS, R117, R117SS rough valve bodies.
TRIM KITS ONLY. VALVE MUST BE ORDERED SEPARATELY.

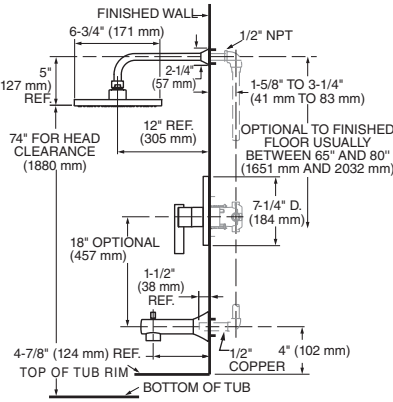
Trim Kit	Model # Description	Finishes	Roughing-In Dimensions
<p>TROPIC®</p> 	<p>T038.502 BATH/SHOWER Trim Kit</p> <ul style="list-style-type: none"> • Metal lever handle • Brass wall escutcheon • Showerhead, arm and flange • Metal slip-on diverter tub spout <p>T038.501 SHOWER ONLY Trim Kit</p> <ul style="list-style-type: none"> • Metal lever handle • Brass wall escutcheon • Showerhead, arm and flange <p>T038.500 SHOWER ONLY Trim Kit</p> <ul style="list-style-type: none"> • Metal lever handle • Brass wall escutcheon <p>2.5 gpm/9.5 L/min. maximum flow rate</p>	<p>.002 Polished Chrome .295 Satin Nickel (PVD)</p> <p>.002 Polished Chrome .295 Satin Nickel (PVD)</p> <p>.002 Polished Chrome .295 Satin Nickel (PVD)</p>	
<p>TROPIC®</p>  	<p>T038.508 BATH/SHOWER Trim Kit</p> <ul style="list-style-type: none"> • Metal Lever handle • Brass wall escutcheon • Water Saving FloWise® showerhead with arm and flange • Metal slip-on diverter tub spout • LESS valve <p>T038.507 SHOWER ONLY Trim Kit</p> <ul style="list-style-type: none"> • Metal lever handle • Brass wall escutcheon • Water Saving FloWise® showerhead with arm and flange • LESS valve <p>1.5 gpm/5.7 L/min. maximum flow rate</p>	<p>.002 Polished Chrome .295 Satin Nickel (PVD)</p> <p>.002 Polished Chrome .295 Satin Nickel (PVD)</p>	





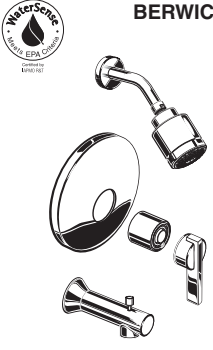
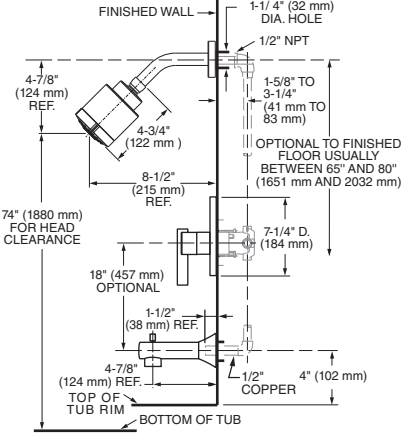

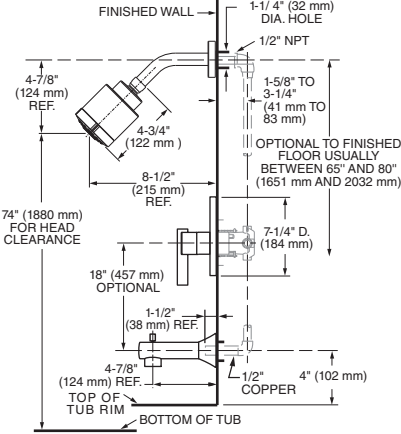
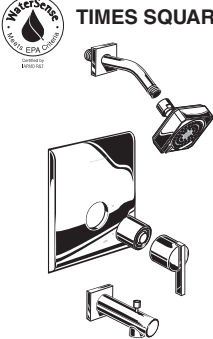
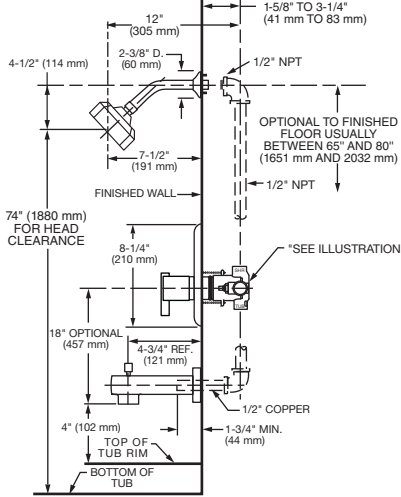

Trim Kits for R110, R110SS, R115, R115SS, R117, R117SS rough valve bodies.
TRIM KITS ONLY. VALVE MUST BE ORDERED SEPARATELY.

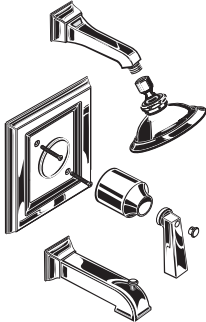
Trim Kit	Model # Description	Finishes	Roughing-In Dimensions
<p>HAMPTON®</p>  <p></p>	<p>T215.7XX BATH/SHOWER Trim Kit</p> <ul style="list-style-type: none"> • Brass wall escutcheon • Adjustable brass showerhead • Shower arm and flange • Metal slip-on diverter tub spout <p>T212.7XX SHOWER ONLY Trim Kit</p> <ul style="list-style-type: none"> • Brass wall escutcheon • Adjustable brass showerhead • Shower arm and flange <p>T211.7XX VALVE ONLY Trim Kit</p> <ul style="list-style-type: none"> • Brass wall escutcheon <p>2.5 gpm/9.5 L/min. maximum flow rate</p>	<p>Porcelain Lever Handle Finishes</p> <p>.002 Polished Chrome</p> <p>Metal Lever Handle Finishes</p> <p>.002 Polished Chrome .099 Polished Brass (PVD) .295 Satin Nickel (PVD)</p>	
<p>DAZZLE®</p>  <p></p>	<p>T028.502 BATH/SHOWER Trim Kit</p> <ul style="list-style-type: none"> • Metal lever handle • Brass wall escutcheon • 3-function showerhead, arm and flange • Metal slip-on diverter tub spout <p>T028.501 SHOWER ONLY Trim Kit</p> <ul style="list-style-type: none"> • Metal lever handle • Brass wall escutcheon • 3-function showerhead, arm and flange <p>T028.500 VALVE ONLY Trim Kit</p> <ul style="list-style-type: none"> • Metal lever handle • Brass wall escutcheon <p>2.5 gpm/9.5 L/min. maximum flow rate</p>	<p>.002 Polished Chrome .224 Oil Rubbed Bronze .295 Satin Nickel (PVD)</p> <p>.002 Polished Chrome .224 Oil Rubbed Bronze .295 Satin Nickel (PVD)</p> <p>.002 Polished Chrome .224 Oil Rubbed Bronze .295 Satin Nickel (PVD)</p>	
<p>BERWICK®</p>  <p></p>	<p>T430.502 BATH/SHOWER Trim Kit</p> <ul style="list-style-type: none"> • Metal wall escutcheon • Metal lever handle • 6-3/4" Brass rain showerhead • Metal slip-on diverter tub spout <p>T430.501 SHOWER ONLY Trim Kit</p> <ul style="list-style-type: none"> • Metal wall escutcheon • Metal lever handle • 6-3/4" Brass rain showerhead <p>T430.500 BATH/SHOWER Trim Kit</p> <ul style="list-style-type: none"> • Metal wall escutcheon • Metal lever handle <p>2.5 gpm/9.5 L/min. maximum flow rate</p>	<p>.002 Polished Chrome .295 Satin Nickel (PVD)</p> <p>.002 Polished Chrome .295 Satin Nickel (PVD)</p> <p>.002 Polished Chrome .295 Satin Nickel (PVD)</p>	
<p>HAMPTON HANDLE OPTIONS</p> <div style="display: flex; justify-content: space-around; align-items: center;"> <div style="text-align: center;">  <p>710 Porcelain⁺ Lever</p> </div> <div style="text-align: center;">  <p>730 Metal Lever</p> </div> </div> <p>Hampton available with choice of 2 handles. To order: specify the 3 digit handle number. eg: T211.710 = Hampton Valve Only Trim Kit with Porcelain Lever Handle</p>			

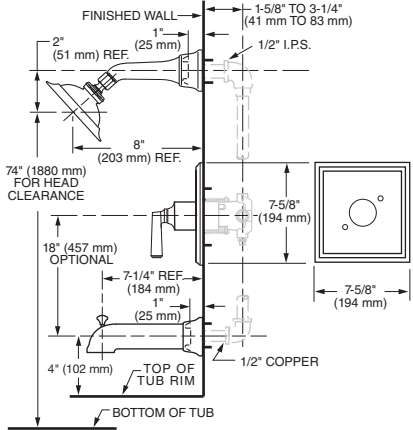
Trim Kits for R110, R110SS, R115, R115SS, R117, R117SS rough valve bodies.
TRIM KITS ONLY. VALVE MUST BE ORDERED SEPARATELY.

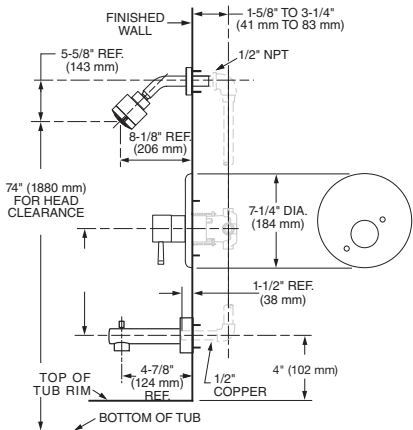
Trim Kit	Model # Description	Finishes	Roughing-In Dimensions
 <p>BERWICK®</p> <p>WaterSense MADE IN CHINA EPA 90000 9100101</p> <p>GREEN EPC C</p>	<p>T430.508 BATH/SHOWER Trim Kit</p> <ul style="list-style-type: none"> • Metal wall escutcheon • Metal lever handle • Water Saving FloWise® 3-function showerhead • Metal slip-on diverter tub spout <p>T430.507 SHOWER ONLY Trim Kit</p> <ul style="list-style-type: none"> • Metal wall escutcheon • Metal lever handle • Water Saving FloWise 3-function showerhead <p>2.0 gpm/7.6 L/min. maximum flow rate</p>	<p>.002 Polished Chrome .295 Satin Nickel (PVD)</p> <p>.002 Polished Chrome .295 Satin Nickel (PVD)</p>	
 <p>TIMES SQUARE®</p> <p>GREEN EPC C</p>	<p>T184.502 BATH/SHOWER Trim Kit</p> <ul style="list-style-type: none"> • Metal wall escutcheon • Metal lever handle • 8" Square brass rain showerhead • Metal slip-on diverter tub spout <p>T184.501 SHOWER ONLY Trim Kit</p> <ul style="list-style-type: none"> • Metal wall escutcheon • Metal lever handle • 8" Square brass rain showerhead <p>T184.500 BATH/SHOWER Trim Kit</p> <ul style="list-style-type: none"> • Metal wall escutcheon • Metal lever handle <p>2.5 gpm/9.5 L/min. maximum flow rate</p>	<p>.002 Polished Chrome .295 Satin Nickel (PVD)</p> <p>.002 Polished Chrome .295 Satin Nickel (PVD)</p> <p>.002 Polished Chrome .295 Satin Nickel (PVD)</p>	
 <p>TIMES SQUARE®</p> <p>WaterSense MADE IN CHINA EPA 90000 9100101</p> <p>GREEN EPC C</p>	<p>T184.508 BATH/SHOWER Trim Kit</p> <ul style="list-style-type: none"> • Metal wall escutcheon • Metal lever handle • Water Saving 2-function showerhead with arm and flange • Metal slip-on diverter tub spout <p>T430.507 SHOWER ONLY Trim Kit</p> <ul style="list-style-type: none"> • Metal wall escutcheon • Metal lever handle • Water Saving 2-function showerhead with arm and flange <p>2.0 gpm/7.6 L/min. maximum flow rate</p>	<p>.002 Polished Chrome .295 Satin Nickel (PVD)</p> <p>.002 Polished Chrome .295 Satin Nickel (PVD)</p>	

Trim Kits for R110, R110SS, R115, R115SS, R117, R117SS rough valve bodies.
TRIM KITS ONLY. VALVE MUST BE ORDERED SEPARATELY.

Trim Kit	Model # Description	Finishes	Roughing-In Dimensions
<p>TOWN SQUARE®</p>  	<p>T555.502 BATH/SHOWER Trim Kit</p> <ul style="list-style-type: none"> • Metal wall escutcheon • Metal lever handle • Cast brass shower arm • 4 1/2" Rain showerhead • Metal slip-on diverter tub spout <p>T555.501 SHOWER ONLY Trim Kit</p> <ul style="list-style-type: none"> • Metal wall escutcheon • Metal lever handle • Cast brass shower arm • 4 1/2" Rain showerhead <p>T555.500 VALVE ONLY Trim Kit</p> <ul style="list-style-type: none"> • Metal wall escutcheon • Metal lever handle <p>2.5 gpm/9.5 L/min. maximum flow rate</p>	<p>.002 Polished Chrome .224 Oil Rubbed Bronze .295 Satin Nickel (PVD)</p> <p>.002 Polished Chrome .224 Oil Rubbed Bronze .295 Satin Nickel (PVD)</p> <p>.002 Polished Chrome .224 Oil Rubbed Bronze .295 Satin Nickel (PVD)</p>	
<p>SERIN®</p>  	<p>T064.502 BATH/SHOWER Trim Kit</p> <ul style="list-style-type: none"> • Brass wall escutcheon • Adjustable 3-function showerhead • Metal slip-on diverter tub spout <p>T064.501 SHOWER ONLY Trim Kit</p> <ul style="list-style-type: none"> • Brass wall escutcheon • Adjustable 3-function showerhead <p>T064.500 VALVE ONLY Trim Kit</p> <ul style="list-style-type: none"> • Brass wall escutcheon <p>2.5 gpm/9.5 L/min. maximum flow rate</p>	<p>.002 Polished Chrome .295 Satin Nickel (PVD)</p> <p>.002 Polished Chrome .295 Satin Nickel (PVD)</p> <p>.002 Polished Chrome .295 Satin Nickel (PVD)</p>	
<p>SERIN®</p>    	<p>T064.508 BATH/SHOWER Trim Kit</p> <ul style="list-style-type: none"> • Brass wall escutcheon • Water Saving FloWise® 3-function showerhead • Metal slip-on diverter tub spout <p>T064.507 SHOWER ONLY Trim Kit</p> <ul style="list-style-type: none"> • Brass wall escutcheon • Water Saving FloWise® 3-function showerhead <p>2.0 gpm/7.6 L/min. maximum flow rate</p>	<p>.002 Polished Chrome .295 Satin Nickel (PVD)</p> <p>.002 Polished Chrome .295 Satin Nickel (PVD)</p>	