

Features

- Solid brass construction for durability and reliability.
- With overflow.
- 1-1/4" connection.
- Fluid design lines for ease of cleaning.



Codes/Standards









ASME A112.18.2/CSA B125.2

Kohler One-Year Limited Warranty

See website for detailed warranty information.

Available Color/Finishes

Color tiles intended for reference only.

Color	Code	Description
	CP	Polished Chrome
	SN	Vibrant® Polished Nickel
	AF	Vibrant® French Gold
	PB	Vibrant® Polished Brass
	G	Brushed Chrome
	BN	Vibrant® Brushed Nickel
	BV	Vibrant® Brushed Bronze
	2BZ	Oil-Rubbed Bronze
	VNT	Vintage Nickel

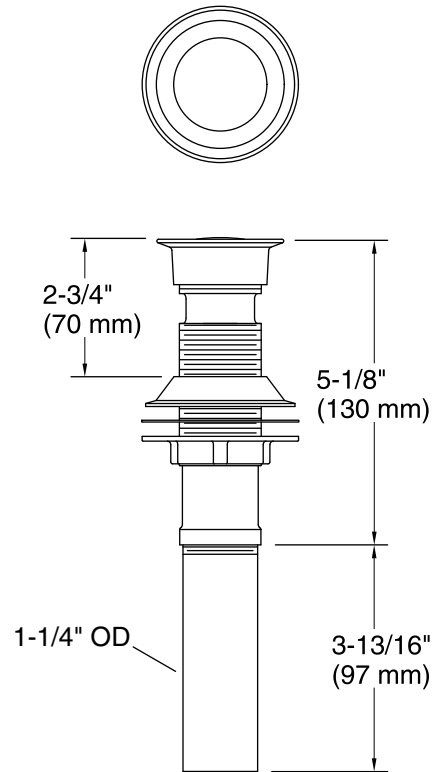

Technical Information

All product dimensions are nominal.

Notes

Install this product according to the installation guide.