

Product Features

- Solid brass
- Dual-threaded mounting piece: 1/2" NPT female, 3/4" NPT male

Code Compliance

This unit meets or exceeds the following:

- ASME A112.18.1
- CSA B125.1
- Listed by IAPMO

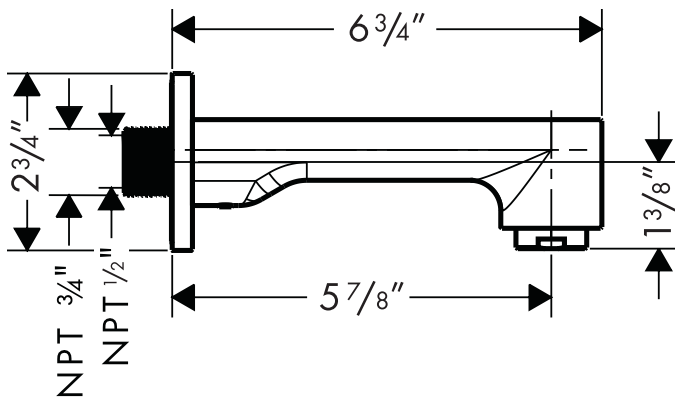

Available Finishes

Chrome

14413001

Brushed Nickel

14413821

Installation Notes

- Requires either 3/4" NPT female or 1/2" NPT male fitting, recessed 3/8" behind surface of finished wall

The measurements shown are for reference only.

Products and specifications shown are subject to change without notice.

Specification sheet revised 2/2008